



Power Edger

Operator's Manual

MODEL PE-280

WARNING **DANGER**



The muffler or catalytic muffler and surrounding cover may become extremely hot.

Always keep clear of exhaust and muffler area, otherwise serious personal injury may occur.

WARNING

The engine exhaust from this product contains chemicals known to the State of California to cause cancer, birth defects or other reproductive harm.



WARNING



Read rules for safe operation and instructions carefully. ECHO provides an Operator's Manual and a Safety Manual. Both must be read and understood for proper and safe operation.

INTRODUCTION

Welcome to the ECHO family. This ECHO product was designed and manufactured to provide long life and on-the-job-dependability. Read and understand this manual and the SAFETY MANUAL you found in the same package. You will find both easy to use and full of helpful operations tips and SAFETY messages.

THE OPERATOR'S MANUAL

Read and understand this manual before operation. Keep it in a safe place for future reference. Contains specifications and information for operation, starting, stopping, maintenance, storage, and assembly specific to this product.

THE SAFETY MANUAL

Read and understand this manual before operation. Keep it in a safe place for future reference. Explains possible hazards involved with the use of Edgers and the measures you should take to make their use safer.

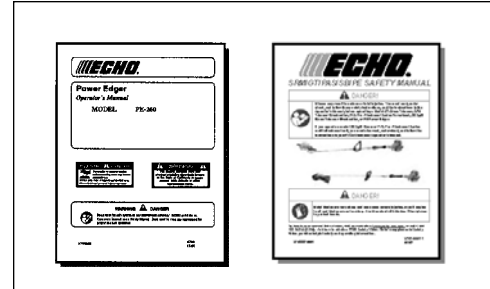

TABLE OF CONTENTS

Introduction.....	2	Maintenance.....	16
- The Operator's Manual.....	2	- Skill Levels.....	16
- The Safety Manual.....	2	- Maintenance Intervals.....	16
Safety.....	3	- Air Filter.....	17
- Manual Safety Symbols and Important Information.....	3	- Fuel Filter.....	17
- International Symbols.....	3	- Spark Plug.....	18
- Personal Condition and Safety Equipment.....	4	- Cooling System.....	18
- Equipment.....	6	- Exhaust System.....	19
Emission Control.....	6	- Carburetor Adjustment.....	20
Description.....	7	- High Altitude Operation.....	20
Contents.....	9	- Drive Shaft Lubrication.....	21
Assembly.....	9	- Blade Replacement / Lubrication.....	22
- Drive Shaft/Power Head.....	9	Troubleshooting.....	23
- Throttle Linkage and Ignition Leads.....	10	Storage.....	24
- Front Handle.....	11	Specifications.....	25
Operation.....	11	Warranty Statements.....	26
- Fuel.....	11	Servicing Information.....	28
- Starting Cold Engine.....	13	- Parts/Serial Number.....	28
- Starting Warm Engine.....	14	- Service.....	28
- Stopping Engine.....	14	- ECHO Consumer Product Support.....	28
- Operating Techniques.....	15	- Warranty Card.....	28
		- Additional or Replacement Manuals.....	28

Specifications, descriptions and illustrative material in this literature are as accurate as known at the time of publication, but are subject to change without notice. Illustrations may include optional equipment and accessories, and may not include all standard equipment.

SAFETY

MANUAL SAFETY SYMBOLS AND IMPORTANT INFORMATION

Throughout this manual and on the product itself, you will find safety alerts and helpful, informational messages preceded by symbols or key words. The following is an explanation of those symbols and key words and what they mean to you.

 **DANGER**

The safety alert symbol accompanied by the word “DANGER” calls attention to an act or condition which **WILL** lead to serious personal injury or death if not avoided.

 **WARNING**

The safety alert symbol accompanied by the word “WARNING” calls attention to an act or condition which **CAN** lead to serious personal injury or death if not avoided.

 **CAUTION**

The safety alert symbol accompanied by the word “CAUTION” calls attention to an act or condition which may lead to minor or moderate personal injury if not avoided.

 **CIRCLE AND SLASH SYMBOL**

This symbol means the specific action shown is prohibited. Ignoring these prohibitions can result in serious or fatal injury.

NOTE













This enclosed message provides tips for use, care and maintenance of the unit.

IMPORTANT

The enclosed message provides information necessary for the protection of the unit.

INTERNATIONAL SYMBOLS

Symbol form/shape	Symbol description/application	Symbol form/shape	Symbol description/application
	Read and understand Operator's Manual.		Fuel and oil mixture
	Wear eyes, ears and head protection		Rotating Cutting Attachment
	Hot Surface		Wear hand protection. Use two handed.
	Safety/Alert		DO NOT smoke near fuel.
	Avoid all power lines. This unit is not insulated against electrical current.		DO NOT allow flames or sparks near fuel.
		Keep bystanders away 15 m (50 ft.)	

Symbol form/shape	Symbol description/application	Symbol form/shape	Symbol description/application
	Keep feet away from blade		Direction of blade
	Thrown objects		Emergency stop
	Wear slip resistant foot wear.		Carburetor adjustment - Low speed mixture
	Primer bulb		Ignition ON/OFF
	Carburetor adjustment - High speed mixture		Carburetor adjustment - Idle speed
	Choke Control "Cold Start" Position (Choke Closed)		Choke Control "Run" Position (Choke Open)

PERSONAL CONDITION AND SAFETY EQUIPMENT



WARNING

Edger users risk injury to themselves and others if the edger is used improperly and or safety precautions are not followed. Proper clothing and safety gear must be worn when operating an edger.

Physical Condition

Your judgment and physical dexterity may not be good:

- if you are tired or sick,
- if you are taking medication,
- if you have taken alcohol or drugs.

Operate unit only if you are physically and mentally well.

Eye Protection

Wear eye protection that meets ANSI Z87.1 or CE requirements whenever you operate the edger.

Hand Protection

Wear no-slip, heavy duty work gloves to improve your grip on the edger handles. Gloves also reduce the transmission of machine vibration to your hands.

Hearing Protection

ECHO recommends wearing hearing protection whenever unit is used.

Proper Clothing

Wear snug fitting, durable clothing;

- Pants should have long legs, shirts with long sleeves.
- **DO NOT WEAR SHORTS,**
- **DO NOT WEAR TIES, SCARVES, JEWELRY.**

Wear sturdy work shoes with non-skid soles;

- **DO NOT WEAR OPEN TOED SHOES,**
- **DO NOT OPERATE UNIT BAREFOOTED.**

Keep long hair away from engine and air intake. Retain hair with cap or net.

Hot Humid Weather

Heavy protective clothing can increase operator fatigue, which may lead to heat stroke. Schedule heavy work for early morning or late afternoon hours when temperatures are cooler.

Vibration and Cold

It is believed that a condition called Raynaud's Phenomenon, which affects the fingers of certain individuals, may be brought about by exposure to vibration and cold. Exposure to vibration and cold may cause tingling and burning sensations, followed by loss of color and numbness in the fingers. The following precautions are strongly recommended, because the minimum exposure which might trigger the ailment is unknown.

- Keep your body warm, especially the head, neck, feet, ankles, hands, and wrists.
- Maintain good blood circulation by performing vigorous arm exercises during frequent work breaks, and also by not smoking.
- Limit the hours of operation. Try to fill each day with jobs where operating the edger or other hand-held power equipment is not required.
- If you experience discomfort, redness, and swelling of the fingers, followed by whitening and loss of feeling, consult your physician before further exposing yourself to cold and vibration.





Repetitive Stress Injuries

It is believed that overusing the muscles and tendons of the fingers, hands, arms, and shoulders may cause soreness, swelling, numbness, weakness, and extreme pain in those areas. Certain repetitive hand activities may put you at a high risk for developing a Repetitive Stress Injury (RSI). An extreme RSI condition is Carpal Tunnel Syndrome (CTS), which could occur when your wrist swells and squeezes a vital nerve that runs through the area. Some believe that prolonged exposure to vibration may contribute to CTS. CTS can cause severe pain for months or even years.

To reduce the risk of RSI/CTS, do the following:

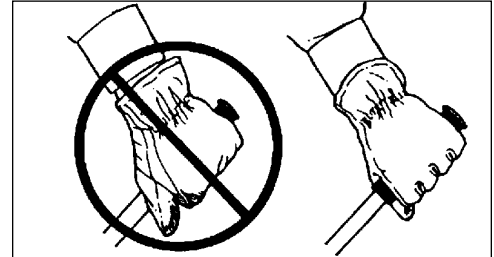
- Avoid using your wrist in a bent, extended, or twisted position. Instead, try to maintain a straight wrist position. Also, when grasping, use your whole hand, not just the thumb and index finger.
- Take periodic breaks to minimize repetition and rest your hands.
- Reduce the speed and force with which you do the repetitive movement.
- Do exercises to strengthen the hand and arm muscles.
- Immediately stop using all power equipment and consult a doctor if you feel tingling, numbness, or pain in the fingers, hands, wrists, or arms. The sooner RSI/CTS is diagnosed, the more likely permanent nerve and muscle damage can be prevented.





WARNING

Do not operate this product indoors or in inadequately ventilated areas. Engine exhaust contains poisonous emissions and can cause serious injury or death.

Read the Manuals

- Provide all users of this equipment with the Operator's Manual and Safety Manual for instructions on Safe Operation.

Clear the Work Area

- Spectators and fellow workers must be warned, and children and animals prevented from coming nearer than 15 m (50 ft.) while the unit is in use.

Keep a Firm Grip

- Hold the front and rear handles with both hands, with thumbs and fingers encircling the handles.

Keep a Solid Stance

- Maintain footing and balance at all times. Do not stand on slippery, uneven or unstable surfaces. Do not work in odd positions or on ladders. Do not over reach.

Avoid Hot Surfaces

- Keep exhaust area clear of flammable debris. Avoid contact during and immediately after operation.

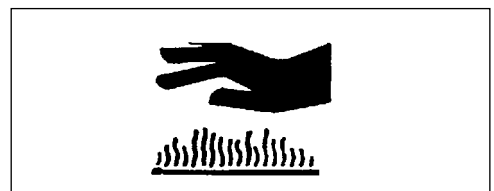

EQUIPMENT



WARNING

Use only ECHO approved attachments. Serious injury may result from the use of a non approved attachment combination. ECHO, INC. will not be responsible for the failure of cutting devices, attachments or accessories which have not been tested and approved by ECHO. Read and comply with all safety instructions listed in this manual and safety manual.

- Check unit for loose/missing nuts, bolts and screws. Tighten and/or replace as needed.
- Inspect shield for damage, and that shield is **securely** in place. Replace if shield is damaged or missing.
- Check that the cutting attachment is firmly attached and in safe operating condition.
- Check that front handle is adjusted for safe, comfortable operation. See Assembly for proper adjustment.



WARNING

Moving parts can amputate fingers or cause severe injuries. Keep hands, clothing and loose objects away from all openings.

- **ALWAYS** stop engine, disconnect spark plug, and make sure all moving parts have come to a complete stop before removing obstructions, clearing debris, or servicing unit.
- **DO NOT** start or operate unit unless all guards and protective covers are properly assembled to unit.
- **NEVER** reach into any opening while the engine is running. Moving parts may not be visible through openings.



WARNING

Check fuel system for leaks due to fuel tank damage, especially if the unit is dropped. If damage or leaks are found, do not use unit, otherwise serious personal injury or property damage may occur. Have unit repaired by an authorized servicing dealer before using.

EMISSION CONTROL (EXHAUST & EVAPORATIVE)

EPA 2010 and Later and/or C.A.R.B. TIER III

The emission control system for the engine is EM/TWC (Engine Modification and 3-way Catalyst) and for the fuel tank the Control System is EVAP (Evaporative Emissions) or N (for nylon tank). Evaporative emission may be applicable to California models only.

EMISSION CONTROL INFORMATION
 ENGINE FAMILY: [E]EHXS.0454KA DISPLACEMENT: 45.0cc
 EMISSION COMPLIANCE PERIOD = 300 HOURS
 THIS ENGINE MEETS U.S. EPA EXH/EVP REGS FOR MODEL YEAR [E]***
 REFER TO OWNER'S MANUAL FOR MAINTENANCE SPECIFICATIONS AND ADJUSTMENTS.
YAMABIKO CORP. [E] [***] [***]

EMISSION CONTROL INFORMATION
 ENGINE FAMILY: [E]EHXS.0214KG DISPLACEMENT: 21.2cc
 EMISSION COMPLIANCE PERIOD = 300 HOURS
 THIS ENGINE MEETS **** U.S. EPA EXH/EVP AND CALIFORNIA EXH AND EVP EMISSION REGULATIONS FOR S.O.R.E.
 REFER TO OWNER'S MANUAL FOR MAINTENANCE SPECIFICATIONS AND ADJUSTMENTS.
YAMABIKO CORP. [***] [E]

An Emission Control Label is located on the engine. (This is an EXAMPLE ONLY, information on label varies by engine FAMILY).

PRODUCT EMISSION DURABILITY (EMISSION COMPLIANCE PERIOD)

The 300 hour emission compliance period is the time span selected by the manufacturer certifying the engine emissions output meets applicable emissions regulations, provided that approved maintenance procedures are followed as listed in the Maintenance Section of this manual.

DESCRIPTION

Locate these safety decals on your unit. Make sure the decals are legible and that you understand and follow the instructions on them. If a decal cannot be read, a new one can be ordered from your ECHO dealer. See PARTS ORDERING instructions for specific information.

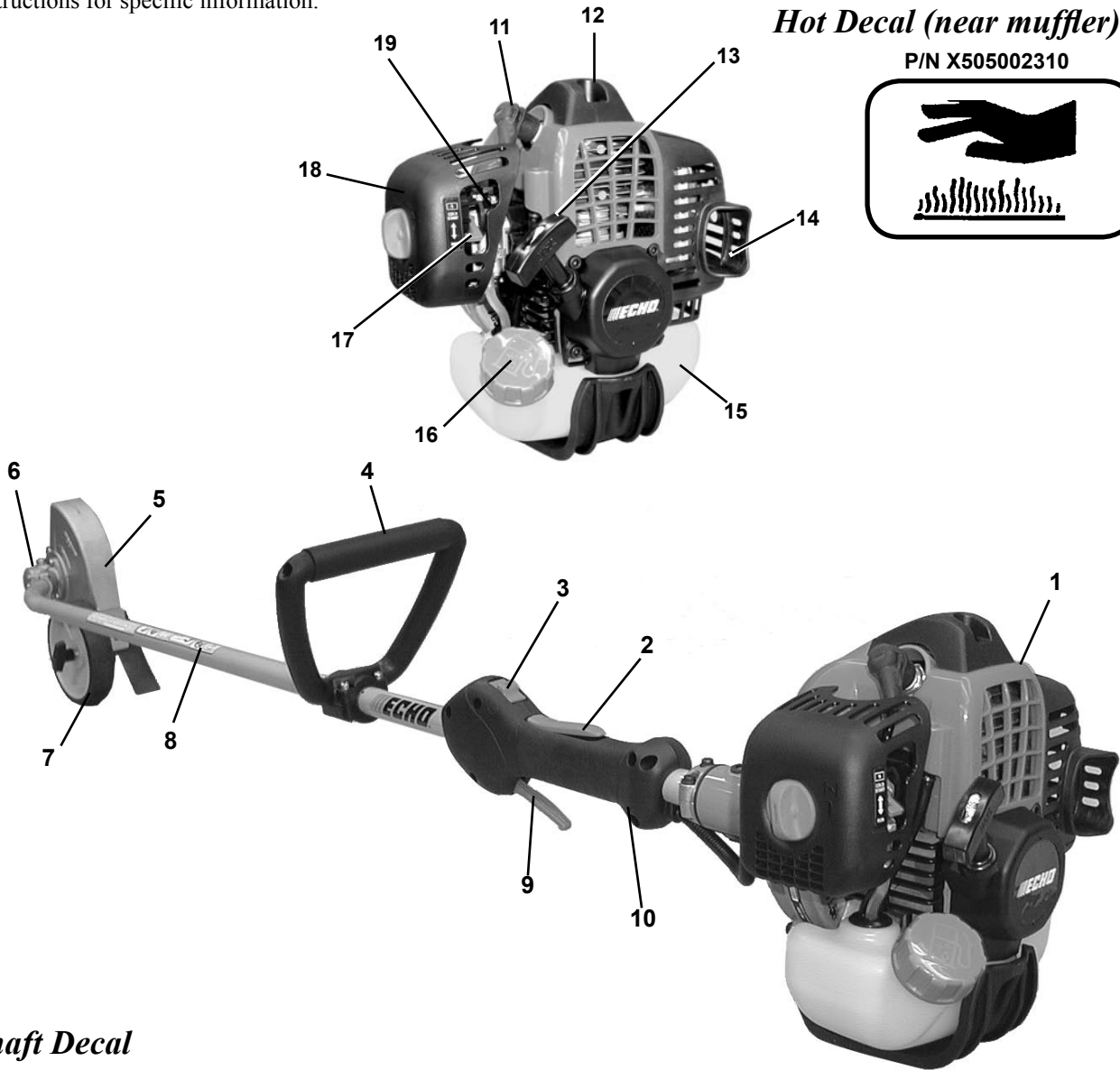

Hot Decal (near muffler)

P/N X505002310

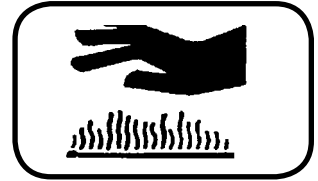



Shaft Decal

P/N X505002510



P/N X505001930



1. **POWER HEAD** - Factory assembled. Includes the engine, clutch, fuel system, ignition system and starter.
2. **THROTTLE TRIGGER LOCKOUT** - This lever must be held during starting. Operation of the throttle trigger is prevented unless throttle trigger lockout lever is engaged.
3. **STOP SWITCH** - "Slide Switch" mounted on top of the throttle Trigger Housing. Move switch FORWARD to RUN, BACK to STOP.
4. **FRONT HANDLE** - The front handle can be repositioned for comfortable operation by loosening the screws and moving the handle.
5. **DEBRIS SHIELD/FLAP** - Mounted over the cutting attachment. Helps protect operator by deflecting debris produced during the edging operation.
6. **BLADE** - Rotates to provide cutting action.
7. **WHEEL** - Adjustable up/down, sets depth of blade.
8. **DRIVE SHAFT ASSEMBLY** - Contains a specially designed liner and the flexible drive shaft.
9. **THROTTLE TRIGGER** - Spring loaded to return to idle when released. When accelerating, press trigger gradually for best operating technique.
10. **GRIP** - Rear (right hand) handle.
11. **SPARK PLUG** - Provides spark to ignite fuel mixture.
12. **TOP GUARD** - Protects arm from the hot engine.
13. **RECOIL STARTER HANDLE** - Pull recoil handle slowly until starter engages, then quickly and firmly. DO NOT let handle snap back or damage to unit will occur.
14. **SPARK ARRESTOR MUFFLER OR SPARK ARRESTOR MUFFLER WITH CATALYST** -The muffler or catalytic muffler controls exhaust noise and emission. The spark arrestor screen prevents hot, glowing particles of carbon from leaving the muffler. Keep exhaust area clear of flammable debris.
15. **FUEL TANK** - Contains fuel and fuel filter.
16. **FUEL TANK CAP** - Cover and seals fuel tank.
17. **CHOKE** - The choke control is located on the air filter case. Move lever to "COLD START" () to close choke for cold starting. Move lever to "RUN" () position to open choke.
18. **AIR CLEANER ASSEMBLY** - Contains replaceable felt element.
19. **PURGE BULB** - Pumping purge bulb before starting engine draws fresh fuel from the fuel tank, purging air from the carburetor. Pump purge bulb until fuel is visible and flows freely in the clear fuel tank return line. Pump purge bulb an additional 4 or 5 times.

CONTENTS

The ECHO product you purchased has been factory pre-assembled for your convenience. Due to packaging restrictions, some assembly may be necessary.

After opening the carton, check for damage. Immediately notify your retailer or ECHO Dealer of damaged or missing parts. Use the contents list to check for missing parts.

- ___ 1, Power Head
 - ___ 1, Drive Shaft Assembly
 - ___ 1, Plastic Bag (Co-Pack)
 - ___ 1, Operator's Manual
 - ___ 1, Safety Manual
 - ___ 1, Warranty Registration Card
 - ___ 1, Front Handle
 - ___ 1, Lower Bracket, Front Handle
 - ___ 4, 5 x 35 mm screws
 - ___ 4, 5 mm nuts*
 - ___ 1, T-Wrench
 - ___ 2, Split pin
 - ___ 1, 4 mm Hexagon Wrench
 - ___ 1, Locking Tool
 - ___ 1, 8 x 10 mm Spanner Wrench
 - ___ 1, Safety Glasses
- * 5mm nuts may not be needed.

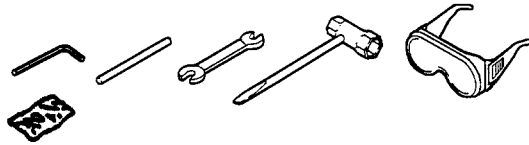
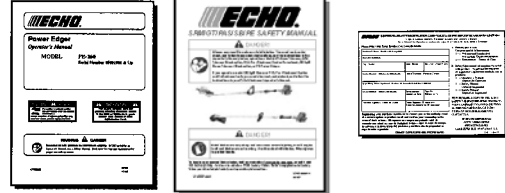

ASSEMBLY

Tools Required: 4 mm Hex Wrench, 8 x 10 mm Open-end Wrench

Parts Required: Power head, Drive Shaft Assembly

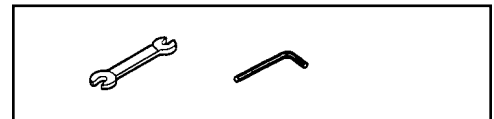

DRIVE SHAFT/POWER HEAD

1. Stand power head upright on a level surface.
2. Loosen the two (2) drive shaft clamp bolts (B) at engine drive shaft clamp, and remove center drive shaft location bolt (A).
3. Remove dust cap and carefully fit drive shaft assembly to engine making sure that inner drive shaft engages into clutch mount.
4. Turn drive shaft housing until locating hole lines up with location hole in clamp and install center drive shaft location bolt (A).

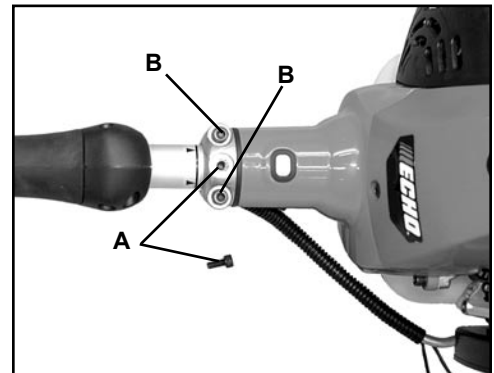

NOTE

Gear Housing must be aligned properly with engine. Aligning center locating hole in driveshaft housing with center drive shaft bolt (A) provides correct alignment.

5. Tighten two (2) drive shaft clamp bolts (B) securely.

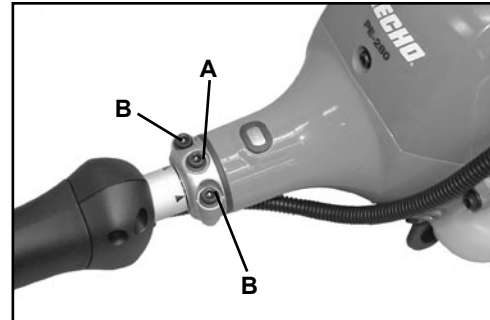

THROTTLE LINKAGE AND IGNITION LEADS

1. Close choke and remove air filter cover.
2. Place inner throttle cable in large hole of carburetor swivel (A).
3. Loosen nuts (B) and place threaded end of throttle linkage in bracket slot. Finger tighten nuts (B).
4. Check throttle for freedom of movement and that wide open throttle / low idle extremes are adjusted properly. If adjustment cannot be achieved with adjusting nuts (B), consult with your Echo Dealer for correct adjustment procedure. Tighten nuts (B).
5. Connect 2 ignition stop leads (C,D) from throttle cable tubing to 2 ignition leads (C,D) on engine.
6. Gather ignition wires and position behind air filter case.
7. Install air filter and cover.

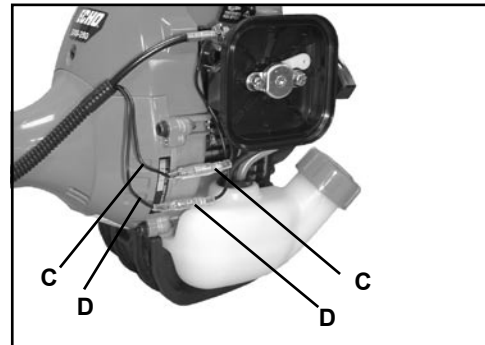
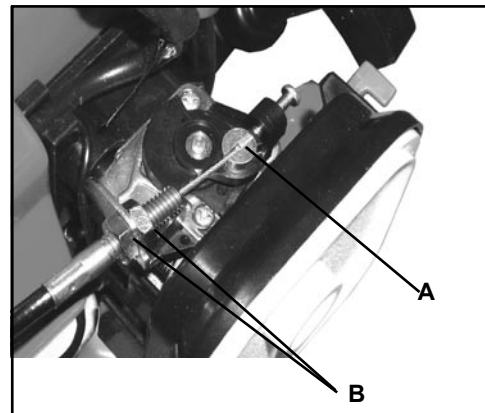

FRONT HANDLE

Tools Required: Cross-Head Screwdriver

Parts Required: Front Handle, Lower Bracket, 4 - 5 x 35 mm screws

NOTE

Label shows minimum spacing for front handle location.

1. Assemble front handle and bracket loosely to drive shaft.
2. Position front handle in comfortable operating position and tighten screws.

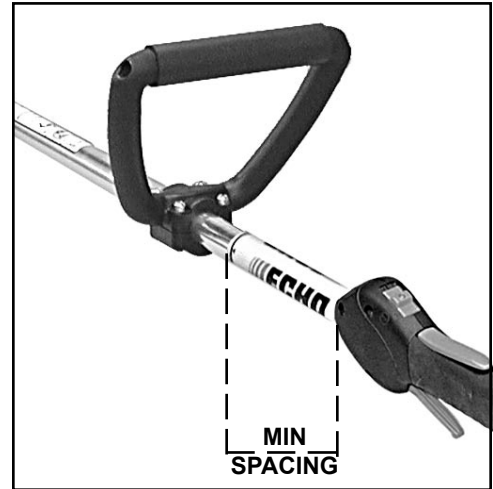

OPERATION



WARNING

Moving parts can amputate fingers or cause severe injuries. Keep hands, clothing and loose objects away from all openings. Always stop engine, disconnect spark plug, and make sure all moving parts have come to a complete stop before removing obstructions, clearing debris, or servicing unit.



WARNING

Operation of this equipment may create sparks that can start fires around dry vegetation. This unit is equipped with a spark arrestor and a spark arrestor may be required. The operator should contact local fire agencies for laws or regulations relating to fire prevention requirements.

FUEL

NOTICE: Use of unmixed, improperly mixed, or fuel older than 90 days, (stale fuel), may cause hard starting, poor performance, or severe engine damage and void the product warranty. Read and follow instructions in the Storage section of this manual.



WARNING

Alternative fuels, such as E-15 (15% ethanol), E-85 (85% ethanol) or any fuels not meeting ECHO requirements are **NOT** approved for use in ECHO 2-stroke gasoline engines. Use of alternative fuels may cause performance problems, loss of power, overheating, fuel vapor lock, and unintended machine operation, including, but not limited to, improper clutch engagement. Alternative fuels may also cause premature deterioration of fuel lines, gaskets, carburetors and other engine components.

Fuel Requirements

Gasoline - Use 89 Octane [R+M/2] (mid grade or higher) gasoline known to be good quality. Gasoline may contain up to 10% Ethanol (grain alcohol) or 15% MTBE (methyl tertiary-butyl ether). Gasoline containing methanol (wood alcohol) is **NOT** approved.

Two Stroke Oil - A two-stroke engine oil meeting ISO-L-EGD (ISO/CD 13738) and J.A.S.O. FC/FD Standards must be used. Echo brand premium Power Blend X™ Universal 2-Stroke Oil meets these standards. Engine problems due to inadequate lubrication caused by failure to use an ISO-L-EGD (ISO/CD 13738) and J.A.S.O. FC/FD certified oil, such as Echo premium Power Blend X™, will void the two-stroke engine warranty.

IMPORTANT

Echo premium Power Blend X™ Universal 2-Stroke Oil may be mixed at 50:1 ratio for application in all Echo engines sold in the past regardless of ratio specified in those manuals.

Handling Fuel



WARNING

Fuel is VERY flammable. Use extreme care when mixing, storing or handling or serious personal injury may result.

- Use an approved fuel container.
- DO NOT smoke near fuel.
- DO NOT allow flames or sparks near fuel.
- Fuel tanks/cans may be under pressure. Always loosen fuel caps slowly allowing pressure to equalize.
- NEVER refuel a unit when the engine is HOT or RUNNING!
- DO NOT fill fuel tanks indoors. ALWAYS fill fuel tanks outdoors over bare ground.
- DO NOT overfill fuel tank. Wipe up spills immediately.
- Securely tighten fuel tank cap and close fuel container after refueling.
- Inspect for fuel leakage. If fuel leakage is found, do not start or operate unit until leakage is repaired.
- Move at least 3m (10 ft.) from refueling location before starting the engine.

Mixing Instructions

1. Fill an approved fuel container with half of the required amount of gasoline.
2. Add the proper amount of 2-stroke oil to gasoline.
3. Close container and shake to mix oil with gasoline.
4. Add remaining gasoline, close fuel container, and remix.

IMPORTANT

Spilled fuel is a leading cause of hydrocarbon emissions. Some states may require the use of automatic fuel shut-off containers to reduce fuel spillage.

After use

- DO NOT store a unit with fuel in its tank. Leaks can occur. Return unused fuel to an approved fuel storage container.

Storage - Fuel storage laws vary by locality. Contact your local government for the laws affecting your area. As a precaution, store fuel in an approved, airtight container. Store in a well-ventilated, unoccupied building, away from sparks and flames.

Fuel to Oil Mix - 50:1 Ratio

U.S.		METRIC	
GAS	OIL	GAS	OIL
Gallons	Fl. oz.	Liter	cc.
1	2.6	4	80
2	5.2	8	160
5	13	20	400

IMPORTANT

Stored fuel ages. Do not mix more fuel than you expect to use in thirty (30) days, ninety (90) days when a fuel stabilizer is added.

IMPORTANT

Stored two-stroke fuel may separate. ALWAYS shake fuel container thoroughly before each use.

STARTING COLD ENGINE



WARNING

The attachment will operate immediately when the engine starts and could result in loss of control and possible serious injury. Keep movable parts of the attachment off the ground and away from objects that could become entangled or thrown.

1. *Stop Switch*

Move stop switch (A) away from the STOP position.

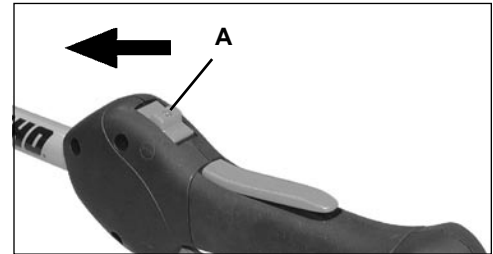

2. *Choke*

Move choke (B) to “Cold Start” (⏏) Position.



3. *Purge Bulb*

Pump purge bulb (C) until fuel will be visible and flows freely in the clear fuel tank return line. Pump bulb an additional 4 or 5 times.



4. *Recoil Starter*

Lay the unit on a flat area and keep movable attachment parts clear of all obstacles. Firmly grasp right hand grip with left hand and fully depress throttle trigger to wide open position. Rapidly pull recoil starter handle/rope (D) until engine fires (or maximum five [5] pulls).

5. *Choke*

After engine fires or five (5) pulls, move choke lever back to “Run” (⏏) position. Hold throttle trigger fully depressed and pull starter handle/rope until engine starts and runs. Release throttle trigger and allow unit to warm up at idle for several minutes.

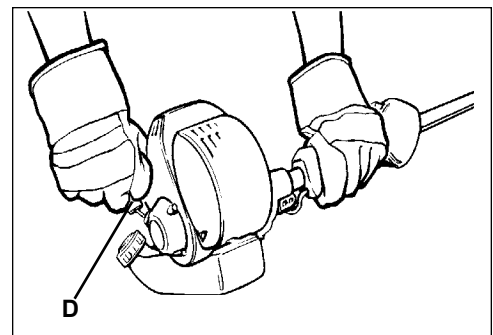

NOTE

If engine does not start with choke in “Run” position after 5 pulls, repeat instructions 2 - 5.

6. After engine warm up, gradually depress throttle trigger to increase engine RPM to operating speed.

STARTING WARM ENGINE

The starting procedure is the same as Cold Start except DO NOT close the choke, and do not depress throttle trigger to wide open position.



WARNING

The attachment should not move at idle, otherwise serious personal injury may result.

NOTE

If attachment moves, readjust carburetor according to “Carburetor Adjustment” instructions in this manual or see your ECHO Dealer.

1. *Stop Switch*
Move stop switch (A) away from the STOP position
2. *Purge Bulb*
Pump purge bulb (C) until fuel will be visible and flows freely in the clear fuel tank return line. Pump bulb an additional 4 or 5 times.
3. *Recoil Starter*
Lay the unit on a flat area and keep movable attachment parts clear of all obstacles. Rapidly pull recoil starter handle/rope (D) until engine fires.

NOTE

If engine does not start after 5 pulls, use Cold Start Procedure.

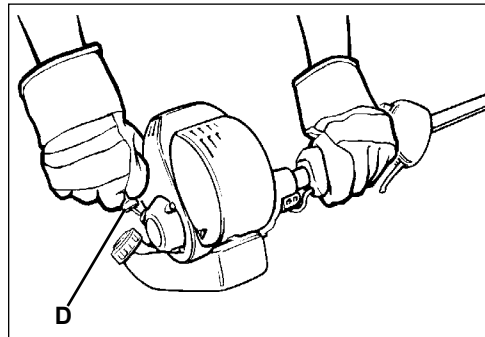
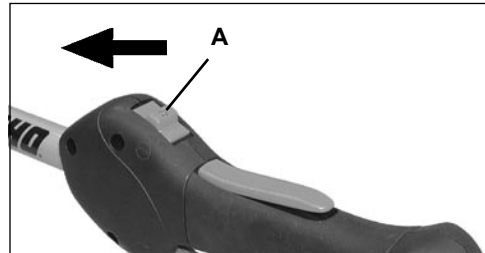

STOPPING ENGINE

1. *Throttle*
Release throttle and allow engine to return to idle before shutting off engine.
2. *Stop Switch*
Move stop switch (A) to STOP position.



WARNING

If engine does not stop when stop switch is moved to STOP position, close choke - COLD START position - to stall engine. Have your ECHO dealer repair stop switch before using edger again.

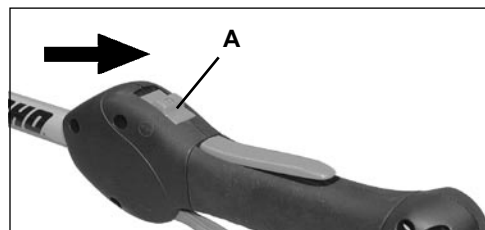

OPERATING TECHNIQUES



WARNING

Engine exhaust IS HOT, and contains Carbon Monoxide (CO), a poison gas. Breathing CO can cause unconsciousness, serious injury, or death. Exhaust can cause serious burns. ALWAYS position unit so that exhaust is directed away from your face and body.

1. Before edging, water the area to soften the ground to make edging easier.
2. Before edging, check the area and remove all obstacles and objects that could be thrown.
3. Plan to edge regularly to make it easier to keep a neat edge and to avoid having to make more than one pass.

NOTE

Blade depth may have to be adjusted due to differences in height between the hard surface and the top of the grass.



WARNING

Never adjust blade height with engine running, otherwise serious personal injury may result.

4. Loosen adjustment knob and adjust the blade's depth of cut to produce a fine cut between sidewalk and grass using a minimum blade depth, usually with about 13 mm (1/2 in.) of the blade into the ground. Tighten adjustment knob.
5. Before edging, plan your direction of travel so that the unit will always be positioned on your right side and so that you walk on a hard surface whenever possible.
6. Hold edger as shown.



WARNING

Before edging, be sure to read and understand the entire Operator's Manual to avoid the chance of serious injury.

7. When starting to edge, run the engine at full throttle, and lower the blade gently into the ground, being careful not to hit the concrete with the blade.
8. Don't force the blade. Move as quickly as the blade will allow.



WARNING

The complete unit, specifically the drive shaft assembly and muffler exhaust area may become very hot during use. Avoid contact during and immediately after operation, otherwise serious personal injury may result.

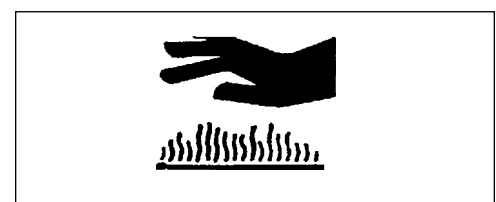
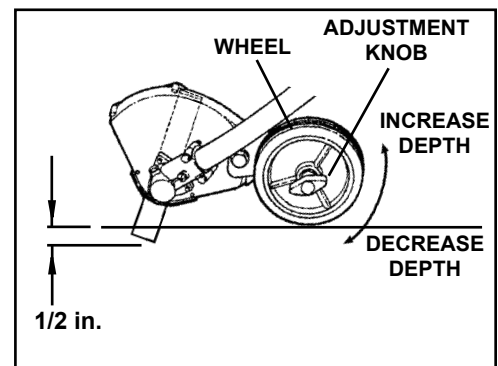

MAINTENANCE



WARNING

Moving parts can amputate fingers or cause severe injuries. Keep hands, clothing and loose objects away from all openings. Always stop engine, disconnect spark plug, and make sure all moving parts have come to a complete stop before removing obstructions, clearing debris, or servicing unit. Allow unit to cool before performing service. Wear gloves to protect hands from sharp edges and hot surfaces.

Your ECHO edger is designed to provide many hours of trouble free service. Regular scheduled maintenance will help your edger achieve that goal. If you are unsure or are not equipped with the necessary tools, you may want to take your unit to an ECHO Service Dealer for maintenance. To help you decide whether you want to DO-IT-YOURSELF or have the ECHO Dealer do it, each maintenance task has been graded. If the task is not listed, see your ECHO Dealer for repairs.

SKILL LEVEL

Level 1 = Easy to do. Common tools may be required.

Level 2 = Moderate difficulty. Some specialized tools may be required.

ECHO offers **REPOWER™** Maintenance Kits and Parts to make your maintenance job easier.

MAINTENANCE INTERVALS

COMPONENT / SYSTEM	MAINTENANCE PROCEDURE	REQ'D SKILL LEVEL	DAILY OR BEFORE USE	EVERY REFUEL	3 MONTHS OR 90 HOURS	YEARLY 600 HOURS
Air Filter	Inspect/Clean	1	I / C *		R*	
Choke	Inspect/Clean	1	I / C			
Fuel Filter	Inspect	1			I *	I / R *
Fuel Cap Gasket	Inspect/Replace	1			I *	R *
Fuel System	Inspect/Replace	1	I (3) *	I (3) *		
Spark Plug	Inspect/Clean	1			I / C / R *	
Cooling System	Inspect/Clean	2	I / C			
Muffler Spark Arrestor	Inspect/Clean/Replace	2			I / C / R *	
Cylinder Exhaust Port	Inspect/Clean/Decarbon	2			I / C	
Drive Shaft	Grease	2			I (1)	
Gear Housing	Grease	2			I (2)	
Blade Replacement	Inspect/Replace	1	I	I	I *	
Recoil Starter Rope	Inspect/Clean	1	I / C *			
Screws/Nuts/Bolts	Inspect/Tighten/Replace	1	I *			

MAINTENANCE PROCEDURE LETTER CODES: I = INSPECT, R = REPLACE, C = CLEAN

IMPORTANT NOTE - Time intervals shown are maximum. Actual use and your experience will determine the frequency of required maintenance.

MAINTENANCE PROCEDURE NOTES:

(1) Apply POWER BLENDX™ grease every 25 hours of use.

(2) Apply POWER BLENDX™ grease every 15 - 25 hours of use.

(3) Low evaporative fuel tanks DO NOT require regular maintenance to maintain emission integrity.

* All recommendations to replace are based on the finding of damage or wear during inspection.

AIR FILTER

Level 1.

Tools required: 25 or 50 mm (1 or 2 in.) Cleaning brush

Parts required: REPOWER™ AIR & FUEL FILTER KIT.

1. Close choke (Cold Start Position []). This prevents dirt from entering the carburetor throat when the air filter is removed. Brush accumulated dirt from air cleaner area.
2. Remove air filter cover. Brush dirt from inside cover.
3. Remove air filter and lightly brush debris from filter. Replace filter if it is damaged, fuel soaked, very dirty, or the rubber sealing edges are deformed.
4. If filter can be reused, be certain it:
 - Fits tightly in the air filter cavity.
 - Is installed with the original side out.
5. Install air filter cover.

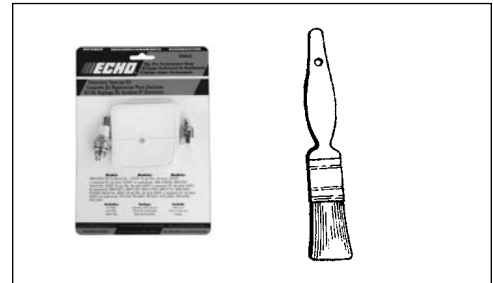

FUEL FILTER

Level 1.

Tools required: 200-250 mm (8-10 in.) length of wire with one end bent into a hook, clean rag, funnel, and an approved fuel container.

Parts required: REPOWER™ AIR & FUEL FILTER KIT.



DANGER
Fuel is **VERY** flammable. Use extreme care when mixing, storing or handling.

1. Use a clean rag to remove loose dirt from around fuel cap and empty fuel tank.
2. Use the “fuel line hook” to pull the fuel line and filter from the tank.
3. Remove the filter from the line and install the new filter.



SPARK PLUG

Level 2.

Tools Required: T-Wrench, feeler gauge, soft metal brush

Parts Required: REPOWER™ Tune-Up Kit

IMPORTANT

Use only NGK BPM-8Y spark plug (BPMR-8Y in Canada) otherwise severe engine damage may occur.

1. Remove spark plug and check for fouling, worn and rounded center electrode.
2. Clean the plug or replace with a new one. DO NOT sand blast to clean. Remaining sand will damage engine.
3. Adjust spark plug gap by bending outer electrode.
4. Tighten spark plug to 150-170 kgf • cm (130-150 in • lbf).

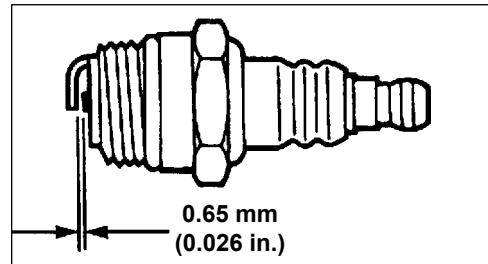
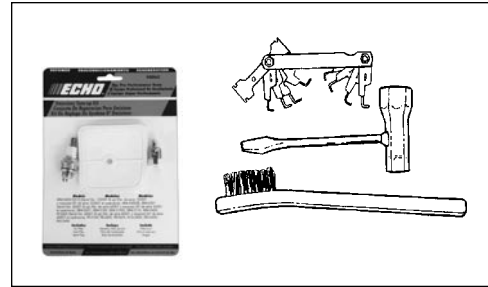

COOLING SYSTEM

Level 2.

Tools required: Cross Head Screwdriver, 3 & 4 mm Hex Wrench, Cleaning Brush, 25 - 50 mm (1 - 2 in.)

Parts Required: None if you are careful.

IMPORTANT

To maintain proper engine operating temperatures, cooling air must pass freely through the cylinder fin area. This flow of air carries combustion heat away from the engine.

Overheating and engine seizure can occur when:

- Air intakes are blocked, preventing cooling air from reaching the cylinder.
- Dust and grass build up on the outside of the cylinder. This build up insulates the engine and prevents the heat from leaving.

Removal of cooling passage blockages or cleaning of cooling fins is considered "Normal Maintenance." Any failure attributed to lack of maintenance is not warranted.

1. Remove spark plug lead.
2. Remove air cleaner cover.
3. Remove (2) muffler cover screws and muffler cover (A).
4. Remove (2) engine cover screws and engine cover (B).

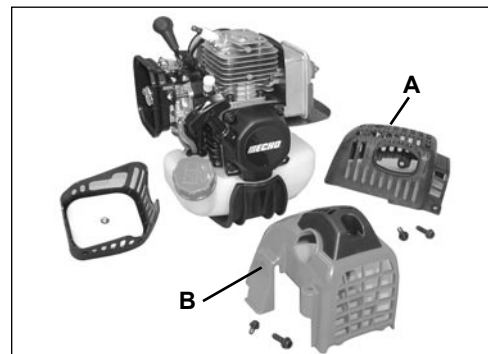
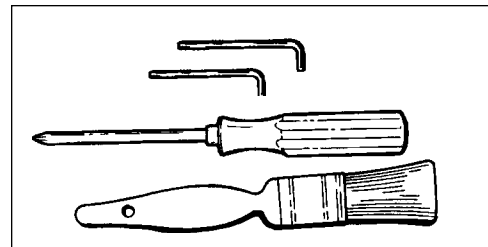

IMPORTANT

DO NOT use a metal scraper to remove dirt from the cylinder fins.

5. Use brush to remove dirt from the cylinder fins.
6. Remove grass and leaves from the grid between the recoil starter and fuel tank.
7. Assemble components in reverse order.



EXHAUST SYSTEM

Spark Arrestor Screen

Level 2.

Tools Required: Cross Head Screwdriver, 4mm Hex Wrench, Soft Metal Brush

Parts Required: Spark Arrestor Screen, Gasket

1. Remove two (2) muffler cover screws and muffler cover (A).
2. Place piston at Top Dead Center (TDC) to prevent carbon/dirt from entering cylinder.
3. Remove spark arrestor screen (B), gasket (C) and exhaust guide (D) from muffler body.
4. Clean carbon deposits from muffler components.

NOTE

When cleaning carbon deposit, be careful not to damage the catalytic element inside muffler.

5. Replace screen if it is cracked, plugged or has holes burned through.
6. Assemble components in reverse order.

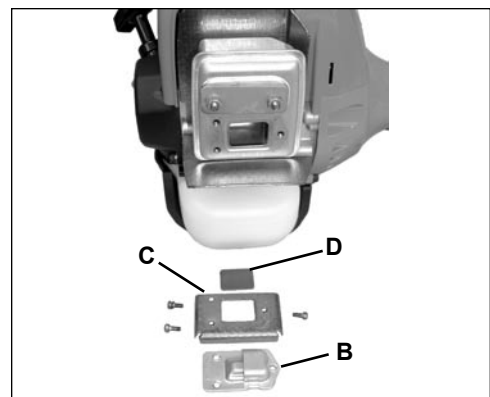
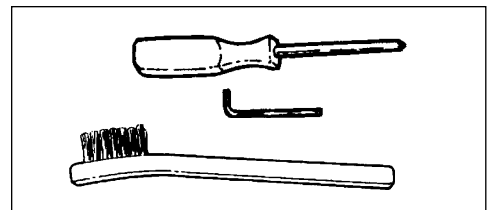

Exhaust Port Cleaning

Level 2.

Tools required: Cross Head Screwdriver, 4mm Hex Wrench, 8x10 mm Open End Wrench,, Wood or plastic scraper

Parts Required: As needed: Heat Shield

1. Remove spark plug lead from spark plug, and remove muffler cover (2 screws).
2. Place piston at top dead center. Remove muffler (A) and heat shield (B).
3. Use a wood or plastic scraping tool to clean deposits from cylinder exhaust port.

IMPORTANT

Never use a metal tool to scrape carbon from the exhaust port. Do not scratch the cylinder or piston when cleaning the exhaust port. Do not allow carbon particles to enter the cylinder.

4. Inspect heat shield, and replace if damaged.
5. Install heat shield and muffler.
6. Tighten muffler mounting bolts (or nuts) to 53-70 in•lbf (60-80 kgf•cm).
7. Install muffler cover and attach spark plug lead.
8. Start engine, and warm to operating temperature.
9. Stop engine, and re-tighten mounting bolts (or nuts) to specifications.

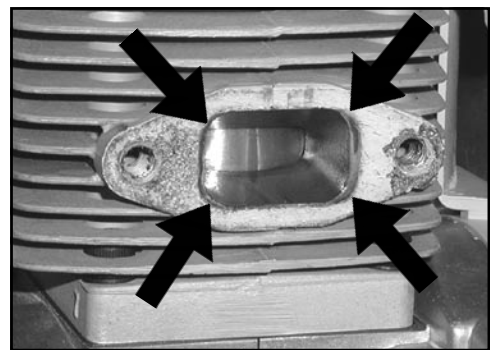
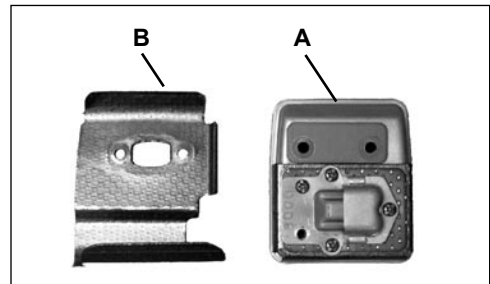
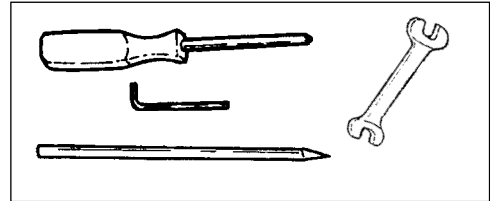

CARBURETOR ADJUSTMENT

Engine Break-In

New engines must be operated a minimum duration of two tanks of fuel break-in before carburetor adjustments can be made. During the break-in period your engine performance will increase and exhaust emissions will stabilize. Idle speed can be adjusted as required.

High Altitude Operation

This engine has been factory adjusted to maintain satisfactory starting, emission, and durability performance up to 1,100 feet above sea level (ASL) (96.0 kPa). To maintain proper engine operation and emission compliance above 1,100 feet ASL the carburetor may need to be adjusted by an authorized ECHO service dealer.

IMPORTANT

If the engine is adjusted for operation *above* 1,100 feet ASL, the carburetor must be re-adjusted when operating the engine *below* 1,100 feet ASL, otherwise severe engine damage may result

Level 2.

Tools required: Screwdriver, Tachometer (ECHO P/N 99051130017)

Parts required: None

NOTE

Every unit is run at the factory and the carburetor is set in compliance with emission regulations. Carburetor adjustments, other than idle speed, must be performed by an authorized ECHO dealer.

1. Check idle speed and reset if necessary. If a tachometer is available, idle speed screw (A) should be set to the specifications found on page 25 "Specifications" of this manual. Turn idle screw (A) clockwise to increase idle speed; counter clockwise to decrease idle speed.



WARNING

When carburetor adjustment is completed, the cutting attachment should not turn at idle, otherwise serious personal injury may result.

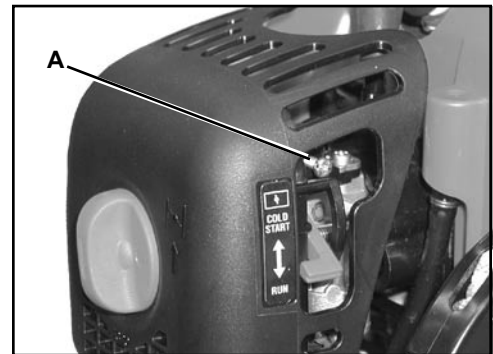
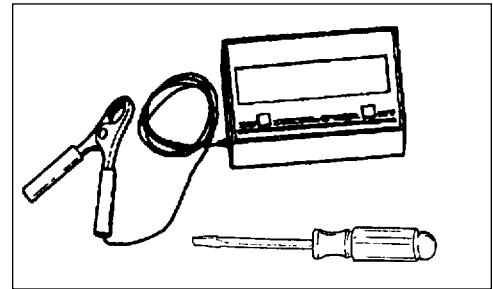

DRIVE SHAFT LUBRICATION

Level 1.

Tools required: 8 mm Open End Wrench, 4 mm Hex Wrench, Clean rag

Parts Required: POWER BLENDX™ 8 oz. (P/N 91014) or Lithium Base Grease.

1. Loosen two (2) screws (A) and remove center locating screw (B). Pull gear box and shield from drive shaft housing.
2. Pull flexible cable from the drive shaft housing, wipe clean and recoat with a thin coating [15 ml (1/2 oz.)] of grease.
3. Slide the flexible cable back in the drive housing. DO NOT get dirt on the flex cable.
4. Install the gear housing and shield assembly.

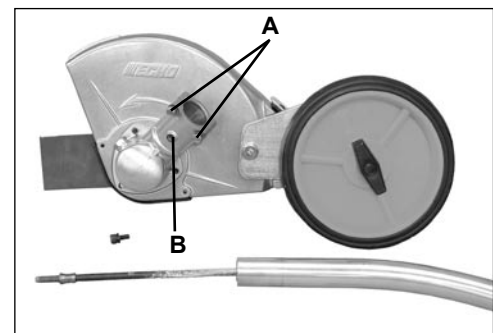

BLADE REPLACEMENT/LUBRICATION

Level 1.

Tools Required: T-wrench, Locking Tool, Needle Nose Pliers,
13 mm Open End Wrench

Parts Required: ECHO® LUBE™ 8 oz. (P/N 91014) or Lithium Base
Grease, Blade P/N 69601552632, split pin P/N
90030020022

NOTE

Grease gear case every 15 - 25 hours of use. Replace blade when it is worn shorter than 6 inches. Remove blade and adapters before greasing to prevent damage to gear and bearings.

1. Shut engine off. Disconnect spark plug lead from spark plug.
2. Remove split pin (A).
3. Rotate blade until holes in inner blade adapter (B) and gear box align. Insert locking tool to lock PTO shaft (C).

NOTE

Blade nut (D) is left hand thread.

4. Remove blade nut (D) in a clockwise direction using T-wrench. Remove outer blade adapter (E), blade (F) and inner blade adapter (B).
5. Clean all loose debris from gear box.
6. Remove plug (G) and check level of grease. Grease should fill gear case to bottom of grease plug hole.
7. Add grease if necessary using manual grease gun or squeeze-type tube. Do not use high pressure grease gun. DO NOT over-fill.
8. Install inner blade adapter (B) onto PTO shaft (C).
9. Install and center new blade (F) onto inner adapter (B).
10. Install outer adapter (E) and nut (D). Tighten nut (D) firmly, counterclockwise (CCW).

IMPORTANT

Never reuse old split pin.

11. Install new split pin (A) to secure nut.

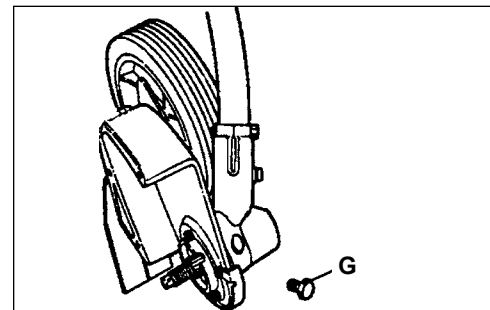
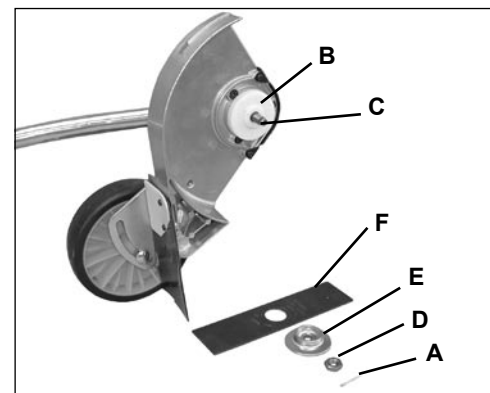
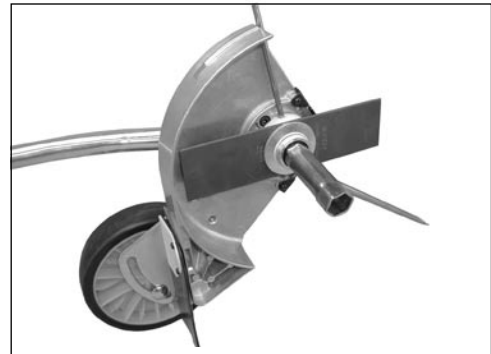
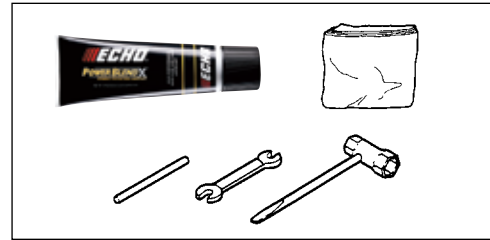

TROUBLESHOOTING

ENGINE PROBLEM TROUBLESHOOTING CHART				
Problem	Check	Status	Cause	Remedy
Engine cranks - starts hard/ doesn't start	Fuel at carburetor	No fuel at carburetor	Fuel strainer clogged Fuel line clogged Carburetor	Clean or replace Clean or replace See your Echo dealer
	Fuel at cylinder	No fuel at cylinder	Carburetor	See your Echo dealer
		Muffler wet with fuel	Fuel Mixture too rich	Open choke Clean/replace air filter Adjust carburetor See your Echo dealer
	Spark at end of plug wire	No spark	Stop switch off Electrical problem Interlock switch	Turn switch to ON See your Echo dealer See your Echo dealer
	Spark at plug	No spark	Spark gap incorrect Covered with carbon Fouled with fuel Plug defective	Adjust to .65mm (0.026 in.) Clean or replace Clean or replace Replace plug
Engine runs, but dies or does not accelerate properly	Air filter	Air filter dirty	Normal wear	Clean or replace
	Fuel filter	Fuel filter dirty	Contaminants/residues in fuel	Replace
	Fuel vent	Fuel vent plugged	Contaminants/residues in fuel	Clean or replace
	Spark Plug	Plug dirty/worn	Normal wear	Clean and adjust or replace
	Carburetor	Improper adjustment	Vibration	Adjust
	Cooling System	Cooling system dirty/plugged	Extended operation in dirty/dusty locations	Clean
	Spark Arrestor Screen	Spark arrestor screen plugged	Normal wear	Replace
Engine does not crank	N/A	N/A	Internal engine problem	See your Echo dealer



DANGER

Fuel vapors are **extremely** flammable and may cause fire and/or explosion. **Never** test for ignition spark by grounding spark plug near cylinder plug hole, otherwise serious personal injury may result.

STORAGE



WARNING

During operation the muffler or catalytic muffler and surrounding cover become hot. Always keep exhaust area clear of flammable debris during transportation or when storing, otherwise serious property damage or personal injury may result.

Long Term Storage (over 30 days)

Do not store your unit for a prolonged period of time (30 days or longer) without performing protective storage maintenance which includes the following:

1. Store unit in a dry, dust free place, out of the reach of children.



DANGER

Do not store in enclosure where fuel fumes may accumulate or reach an open flame or spark.

2. Place the stop switch in the "STOP" position.
3. Remove accumulation of grease, oil, dirt and debris from exterior of unit.
4. Perform all periodic lubrication and services that are required.
5. Tighten all the screws and nuts.
6. **Drain** the fuel tank **completely** and pull the recoil starter handle several times to remove fuel from the carburetor.
7. Remove the spark plug and pour 7 cc (1/4 oz.) of fresh, clean, two-stroke engine oil into the cylinder through the spark plug hole.
 - A. Place a clean cloth over the spark plug hole.
 - B. Pull the recoil starter handle 2-3 times to distribute the oil inside the engine.
 - C. Observe the piston location through the spark plug hole. Pull the recoil handle slowly until the piston reaches the top of its travel and leave it there.
8. Install the spark plug (do not connect ignition cable).

SPECIFICATIONS

MODEL -----	PE-280
Length -----	1765 mm (69.5 in.)
Width -----	315 mm (12.4 in.)
Height -----	320 mm (12.6 in.)
Weight (dry w/cutter head) -----	6.88 kg (15.2 lb.)
Engine Type -----	Air cooled, two-stroke, single cylinder gasoline engine
Bore-----	34.0 mm (1.34 in.)
Stroke-----	31.0 mm (1.22 in.)
Displacement -----	28.1 cc (1.71 cu. in.)
Exhaust -----	Spark arrestor muffler or spark arrestor muffler with catalyst
Carburetor -----	Walbro w/purge bulb
Ignition System -----	CDI (capacitor discharge ignition)
Spark Plug -----	NGK BPM-8Y 0.65mm (0.026 in.)
Fuel -----	Mixed (Gasoline and Two-stroke Oil)
Fuel/Oil Ratio -----	50 : 1 Power Blend X™ ISO-L-EGD (ISO/CD 13738) and J.A.S.O. M345- <u>FC/FD</u> , two-stroke, air-cooled engine oil.
Gasoline-----	Use 89 Octane unleaded. Do not use fuel containing methyl alcohol, more than 10% ethyl alcohol or 15% MTBE. Do not use alternative fuels such as E-15 or E-85.
Oil-----	Power Blend X™ Premium Universal 2-Stroke Oil
Fuel Tank Capacity -----	0.61 lit. (20.6 US fl. oz.)
Recoil Starter System -----	Automatic Recoil Starter
Clutch-----	Centrifugal Type
Drive Shaft-----	6.35 mm (1/4 in.) flexible shaft
Gear Ratio -----	2.07:1
Rotation Direction -----	Clockwise viewed from right side
Shield-----	Open anti-clog
Standard Cutter Head-----	Metal blade
Blade Length -----	203.2 mm (8.0 in.)
Blade Width -----	50.8 mm (2 in.)
Blade Thickness-----	Standard 2.3 mm (0.090 in.), Premium 4.6 mm (0.181 in.)
Handle-----	Front Cushioned D-loop, Rear - Grip
Vibration Reduction -----	Rubber Cushion
Idle Speed (RPM)-----	2,600 - 3,100
Clutch Engagement Speed (RPM)-----	3,900
Wide Open Throttle Speed (RPM)-----	10,400 - 11,400

WARRANTY STATEMENTS

ECHO LIMITED WARRANTY STATEMENT FOR PRODUCT SOLD IN USA AND CANADA BEGINNING 01/01/2010

ECHO'S RESPONSIBILITY

ECHO Incorporated's Limited Warranty, provides to the original purchaser that this ECHO product is free from defects in material and workmanship. Under normal use and maintenance from date of purchase, ECHO agrees to repair or replace at ECHO's discretion, any defective product free of charge at any authorized ECHO servicing dealer within listed below application time periods, limitations and exclusions. **THIS LIMITED WARRANTY IS ONLY APPLICABLE TO ECHO PRODUCTS SOLD BY AUTHORIZED ECHO DEALERS. IT IS EXTENDED TO THE ORIGINAL PURCHASER ONLY, AND IS NOT TRANSFERABLE TO SUBSEQUENT OWNERS EXCEPT FOR EMISSION RELATED PARTS.** Repair parts and accessories replaced under this warranty are warranted only for the balance of the original unit or accessory warranty period. Any damage caused by improper installation or improper maintenance is not covered by this warranty. All parts or products replaced under warranty become the property of ECHO, Inc. This warranty is separate from the Emission control warranty statement supplied with your new product. Please consult the Emission Control Warranty Statement for details regarding emission related parts. For a list of Authorized ECHO Dealers refer to WWW.ECHO-USA.COM or call 1-800-432-ECHO.

OWNER'S RESPONSIBILITY

To ensure trouble free warranty coverage it is important that you register your ECHO equipment on-line at WWW.ECHO-USA.COM or by filling out the warranty registration card supplied with your unit. Registering your product confirms your warranty coverage and provides a direct link if we find it necessary to contact you.

The owner shall demonstrate reasonable care and use, and follow preventative maintenance, storage, fuel and oil usage as prescribed in the operator's manual. Should a product difficulty occur, you must, at your expense, deliver or ship your ECHO unit to an authorized ECHO servicing dealer for warranty repairs (within the applicable warranty period), and arrange for pick-up or return of your unit after the repairs have been made. For your nearest authorized ECHO servicing dealer, call ECHO's Dealer Referral Center, at 1-800-432-ECHO or you can locate an ECHO servicing dealer at WWW.ECHO-USA.COM. Should you require assistance or have questions concerning ECHO's Warranty Statement, you can contact our Consumer Product Support Department at 1-800-673-1558 or contact us through the web at WWW.ECHO-USA.COM.

PRODUCT WARRANTY PERIOD

RESIDENTIAL APPLICATION

- **5 YEAR WARRANTY** - All units for residential, or non-income producing use will be covered by this limited warranty for **five (5) years** from date of purchase.

EXCEPTIONS:

- For two-stroke engine powered products, the electronic ignition module, flexible drive cables, SRM solid drive shafts, and TC tines are warranted for the **life*** of the product on parts only.
- Cutting attachments such as, but not limited to, bars, chains, sprockets, blades, and nylon trimmer heads for residential or non-income producing use will be covered for failures due to defects in material or workmanship for a period of **60 days** from original product purchase date. Any misuse from contact with concrete, rocks, or other structures is not covered by this warranty.
- ECHO's Rapid Loader String Head carries a lifetime warranty on the line locking system, parts only; no labor. Refer to your operator's manual for string head installation and maintenance instructions.
- All SB-Series and PRO ATTACHMENT SERIES Split Shaft attachments carry the same warranty duration as the units they are designed to fit.

COMMERCIAL APPLICATION

- **1 YEAR WARRANTY** - All Chain Saws, QuikVent Saws, and Cut-Off Saws for commercial, institutional, agricultural, industrial, or income producing use will be covered by this limited warranty for one **(1) year** from the date of purchase.
- **2 YEAR WARRANTY** - All other units for commercial, institutional, agricultural, industrial, or income producing use will be covered by this limited warranty for two **(2) years** from the date of purchase.

EXCEPTIONS:

- For two-stroke engine powered products, the electronic ignition module, flexible drive cables, SRM solid drive shafts and TC tines, are warranted for the **life*** of the product on parts only.
- Cutting attachments such as, but not limited to, bars, chains, sprockets, blades, and nylon trimmer heads for commercial, institutional, agricultural, industrial, rental, or income producing will be covered for failures due to defects in material or workmanship for a period of **30 days** from original product purchase date. Any misuse from contact with concrete, rocks, or other structures is not covered by this warranty.
- ECHO's Rapid Loader String Head carries a lifetime warranty on the line locking system, parts only; no labor. Refer to your operator's manual for string head installation and maintenance instructions.
- All SB-Series and PRO ATTACHMENT SERIES Split Shaft attachments carry the same warranty duration as the units they are designed to fit.

RENTAL APPLICATION - 90 DAYS WARRANTY

- Units for rental use will be covered against defects in material and workmanship for a period of 90 days from the date of purchase.

* ECHO's liability under the "Lifetime" coverage is limited to furnishing parts specified under the PRODUCT WARRANTY PERIOD section of this warranty statement for "**Life**" free of charge for a period of ten (10) years after the date of the complete unit's final production.

PURCHASED REPAIR PARTS, SHORT BLOCKS AND ACCESSORIES

- 90-day residential, or non-income producing warranty
- 30-day commercial, institutional, agricultural, industrial, income producing, or rental application warranty

ATTENTION TWO-STROKE ENGINE POWER PRODUCT OWNERS

This ECHO two-stroke engine power product is a quality-engineered unit which has been manufactured to exact tolerances to provide superior performance. To help ensure the performance of the unit, it is required to use two-stroke oil which meets the ISO-L-EGD Standard per ISO/CD 13738 and JASO M345/FC/FD Standards. **ECHO Power Blend™ Two-Stroke Oil** is a premium two-stroke oil specifically formulated to meet ISO-L-EGD (ISO/CD 13738) and JASO M345/FC/FD Standards. The use of two-stroke oils designed for other applications, such as for outboard motors or lawnmowers can result in severe engine damage, and will void your two-stroke engine limited warranty.

THIS WARRANTY DOES NOT COVER DAMAGE CAUSED BY:

- Lack of lubrication or engine failure, due to the use of two-stroke oils that do not meet the ISO-L-EGD (ISO/CD 13738) and JASO M345/FC/FD Standards. Engine problems due to inadequate lubrication caused by failure to use an ISO-L-EGD compliant and JASO M345/FC/FD registered oil, will void the two-stroke engine limited warranty. **ECHO Power Blend™ Two-Stroke Oil** meets the ISO-L-EGD and JASO M345/FC/FD Standard. Emission related parts are covered for 5 years residential use or 2 years commercial use regardless of two-stroke oil used, per the statement listed in the EPA or California Emission Defect Warranty Explanation.
- Damage caused by use of gasohol, containing methanol (wood alcohol), or gasoline containing less than 89 octane. Only use gasoline which contains 89 octane or higher. Gasohol which contains a **maximum** 10% ethanol (grain alcohol) or 15% MTBE (methyl/tertiary/butyl/ether) is also approved. The prescribed mixing ratio of gasoline to oil is listed on the ECHO oil label and covered in your operator's manual.
- Engine damage caused by use of ether or any starting fluids.
- Damage caused by tampering with engine speed governor or emission components, or running engines above specified and recommended engine speeds as listed in your operator's manual.
- Operation of the unit with improperly maintained/removed cutting shield or removed/damaged air filter.
- Damage caused by dirt, pressure or steam cleaning the unit, salt water, corrosion, rust, varnish, abrasives, and moisture.
- Defects, malfunctions or failures resulting from abuse, misuse, neglect, modifications, alterations, normal wear, improper servicing, or use of unauthorized attachments.
- Incorrect storage procedures, stale fuel, including failure to provide or perform required maintenance services as prescribed in the operator's manual. Preventative maintenance as outlined in the operators manual is the customer's responsibility.
- Failures due to improper set-up, pre-delivery service or repair service by anyone other than authorized ECHO servicing dealer during the warranty period.
- Certain parts and other items are not warranted, including but not limited to: lubricants, starter cords, and engine tune-ups.
- Use of spark plugs other than those meeting performance and durability requirements of the OEM spark plug listed in the Operator's Manuals.
- Overheating or carbon scoring failures due to restricted, clogged exhaust port or combustion chamber, including damage to spark arrester screen.
- Adjustments after the first (30) thirty days and beyond, such as carburetor adjustment and throttle cable adjustment.
- Damage to gears or gear cases caused by contaminated grease or oil, use of incorrect type or viscosity of lubricants, and/or failure to comply with recommended grease or oil change intervals.
- Damage caused by loading SHRED 'N' VAC® beyond recommended capacity.
- Damage caused by pump or sprayer running dry, pumping or spraying caustic or flammable materials, or lack of or broken strainers.
- Additional damage to parts or components due to continued use after operational problem or failure occurs. Should operational problem or failure occur, the product should not be used, but delivered as is to an authorized ECHO servicing dealer.

It is a dealer's and/or customer's responsibility to complete and return the warranty registration card supplied with your ECHO product or by visiting WWW.ECHO-USA.COM. Your receipt of purchase including date, model and serial number must be maintained and presented to an authorized ECHO servicing dealer for warranty service. Proof of purchase rests solely with the customer. Some states do not allow limitations on how long an implied warranty lasts, so the above limitations may not apply to you. Some states do not allow the exclusion or limitation of incidental or consequential damages, so you may also have other specific legal rights which vary from state to state. This limited warranty is given by ECHO Incorporated, 400 Oakwood Rd., Lake Zurich, IL 60047.

DISCLAIMER OF IMPLIED WARRANTIES

This limited warranty is in lieu of all other expressed or implied warranties, including any warranty of FITNESS FOR A PARTICULAR PURPOSE OR USE and any implied warranty of **MERCHANTABILITY** otherwise applicable to this product. ECHO and its affiliated companies shall not be liable for any special incidental or consequential damage, including lost profits. There are no warranties extended other than as provided herein. This limited warranty may be modified only by ECHO.

99922201032
12/03/09

ECHO INCORPORATED EMISSION CONTROL WARRANTY STATEMENT FOR ECHO AND SHINDAIWA BRANDS

The Environmental Protection Agency (EPA) and the California Air Resources Board (C.A.R.B.) and ECHO Incorporated (ECHO Inc.) are pleased to explain the emission control system warranty on your 2010 and later equipment/small off-road engine (SORE). New equipment/SORE must be designed, built and equipped to meet stringent EPA and C.A.R.B. anti-smog standards. ECHO Inc. must warrant the emission control system on your equipment/SORE for the periods of time listed below, provided there has been no abuse, neglect or improper maintenance of your equipment/SORE. Your emission control system may include parts such as: carburetor, fuel-injection system, ignition system, catalytic converter/muffler, fuel tank, fuel feed lines, fuel cap assembly, spark plug, air filters, and other associated components. Where a warrantable condition exists, ECHO Inc will repair your equipment/SORE at no cost to you including diagnosis, parts and labor. The Emission Control System warranty is extended to the original owner including all subsequent owners.

MANUFACTURER'S WARRANTY COVERAGE:

The emission control system is warranted for 2 years or the length of the ECHO Inc. warranty, whichever is longer. If any emission-related part on your equipment is defective, the part will be repaired or replaced by ECHO Inc. or its Authorized Service Representative.

OWNER'S WARRANTY RESPONSIBILITIES:

As the equipment/SORE owner, you are responsible for the performance of the required maintenance listed in your Operator's Manual. ECHO Inc. recommends that you retain all receipts covering maintenance on your equipment/SORE however, ECHO Inc. cannot deny warranty solely for the lack of receipts or for your failure to ensure the performance of all scheduled maintenance. As the equipment/SORE owner, you should be aware that ECHO Inc. may deny you warranty coverage if your equipment/SORE or a part has failed due to abuse, neglect, improper maintenance or unapproved modifications.

You are responsible for presenting your equipment/SORE to an ECHO Inc. authorized service representative as soon as a problem exists. The warranty repairs should be completed in a reasonable amount of time, not to exceed 30 days. If a warrantable condition exists and there is no Authorized Dealer within 100 miles, ECHO Inc. will pay to ship the unit to the nearest authorized dealer. If you have questions regarding your warranty coverage, you should contact ECHO Inc. at 1-800-673-1558, web site WWW.ECHO-USA.COM or contact Shindaiwa at 1-877-986-7783, web site WWW.SHINDAIWA.COM.

WHAT DOES THIS WARRANTY COVER?

ECHO Inc. warrants that your equipment/SORE was designed, built and equipped to conform with applicable EPA and C.A.R.B. emissions standards and that your equipment/SORE is free from defects in material and workmanship that would cause it to fail to conform with applicable requirements for 2 years or the length of the ECHO Inc. warranty, whichever is longer. The warranty period begins on the date the product is purchased by an end user.

HOW WILL A COVERED PART BE CORRECTED?

If there is a defect in a part covered by this warranty, any ECHO Inc. Authorized Service Dealer will correct the defect. You will not have to pay anything to have the part adjusted, repaired or replaced. This includes any labor and diagnosis for warranted repairs performed by the dealer. In addition, engine parts not expressly covered under this warranty but whose failure is a result of a failure of a covered part will be warranted.

WHAT PARTS ARE COVERED?

Any applicable emission related part not scheduled for "required maintenance" will be repaired or replaced within the warranty period. The repaired or replaced part will be warranted for the remaining ECHO Inc. warranty period.

Any warranted part that is scheduled only for regular inspection in the written instructions supplied is warranted for the warranty period stated above. Any such part repaired or replaced under warranty will be warranted for the remaining ECHO Inc. warranty period.

Any emission related part scheduled for replacement during "required maintenance" is warranted for the period of time prior to the first scheduled replacement point for that part. Any such part repaired or replaced under warranty shall be warranted for the remainder of the period prior to the first scheduled replacement point for that part.

Any manufacturer-approved replacement part may be used in the performance of any warranty maintenance or repairs on emission related parts, and must be provided without charge if the part is still under warranty.

Any replacement part that is equivalent in performance and durability may be used in non-warranty maintenance or repairs, and shall not reduce the warranty obligations of the manufacturer.

Throughout the equipment/SORE warranty period, ECHO Inc. will maintain a supply of warranted parts sufficient to meet the expected demand for such parts.

SPECIFIC EMISSION RELATED WARRANTED PARTS:

- Electronic Ignition System
- Catalytic Converter / Muffler Assembly
- Choke
- Fuel Tank
- Air Filter
- Spark Plug
- Carburetor (complete assembly or replaceable components)
- Fuel-Injection Assembly (or replaceable components)
- Fuel Cap Assembly
- Fuel Feed Line (and associated clamps/connectors as applicable)

WHAT IS NOT COVERED?

Any failure caused by abuse, neglect, improper maintenance, unapproved modifications, use of unapproved add-on parts/modified parts or unapproved accessories.

This Emission Control Warranty is valid only for the U.S.A., it's Territories, and Canada.

99922201033
01/2010

NOTES

NOTES

NOTES

SERVICING INFORMATION

PARTS/SERIAL NUMBER

Genuine ECHO Parts and ECHO REPOWER™ Parts and Assemblies for your ECHO products are available only from an Authorized ECHO Dealer. When you do need to buy parts **always** have the Model Number, Type and Serial Number of the unit with you. You can find these numbers on the engine housing. For future reference, write them in the space provided below.

Model No. _____ SN. _____

SERVICE

Service of this product during the warranty period must be performed by an Authorized ECHO Service Dealer. For the name and address of the Authorized ECHO Service Dealer nearest you, ask your retailer or call: 1-800-432-ECHO (3246). Dealer information is also available on our Web Site. When presenting your unit for Warranty service/repairs, proof of purchase is required.

ECHO CONSUMER PRODUCT SUPPORT

If you require assistance or have questions concerning the application, operation or maintenance of this product you may call the ECHO Consumer Product Support Department at 1-800-673-1558 from 8:30 am to 4:30 pm (Central Standard Time) Monday through Friday. Before calling, please know the model and serial number of your unit.

WARRANTY REGISTRATION

To ensure trouble free warranty coverage it is important that you register your ECHO equipment on-line at www.echo-usa.com or by filling out the warranty registration card supplied with your unit. Registering your product confirms your warranty coverage and provides a direct link between you and ECHO if we find it necessary to contact you.

ADDITIONAL OR REPLACEMENT MANUALS

Replacement Operator, Safety Manuals, and Parts Catalogs are available from your ECHO dealer or at www.echo-usa.com or by contacting ECHO Inc., 400 Oakwood Road, Lake Zurich, IL 60047 (800-673-1558). Always check the ECHO Web Site for updated information.

Safety Videos are available from your Echo dealer. A \$5.00 shipping charge will be required for each video.

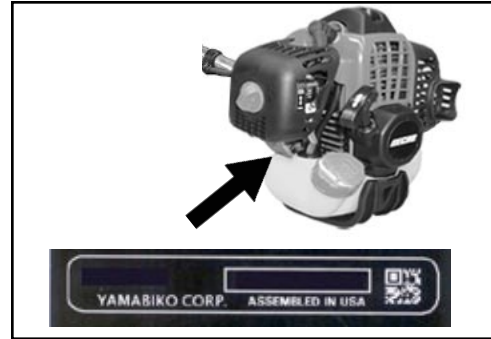

DEALER?

Call
1-800-432-ECHO

1-800-432-3246

or

www.echo-usa.com

CONSUMER PRODUCT SUPPORT

1-800-673-1558

8:30 - 4:30 Mon - Fri C.S.T.



ECHO

ECHO, INCORPORATED

400 OAKWOOD ROAD

LAKE ZURICH, IL 60047

www.echo-usa.com

S63111001001/S63111006135

S63012001001/S63012008944