



99944200595

PAS Articulating Hedge Clipper Attachment

FOR MODELS: SRM-2100SB, 2400SB, 210SB, 211SB, 225SB, 260SB, 261SB, PAS-2100, 2400, 2601, 210, 211, 225, 225VP, 225VPB, 230, 231, 260, 261, 265, 266 (NOT FOR USE ON PAS-280)

Operator's Manual

WARNING



Users of this equipment risk injury to themselves and others if the unit is used improperly and/or safety precautions are not followed. ECHO provides an operator's manual. It must be read and understood for proper and safe operation. Failure to do so could result in serious injury.

Specifications, descriptions and illustrative material in this literature are as accurate as known at the time of publication, but are subject to change without notice. Illustrations may include optional equipment and accessories, and may not include all standard equipment.

X7532095609

© 10/2016 ECHO Inc.

TABLE OF CONTENTS

Table of Contents 2

Introduction 3

 The Operator’s Manual 3

 The Safety Manual 3

Servicing Information 3

 Parts/Serial Number 3

 Service 4

 Echo Consumer Product Support 4

 Product Registration 4

 Additional or Replacement Manuals 4

Safety 4

 Manual Safety Symbols and Important Information 5

 International Symbols 5

 Personal Condition and Safety Equipment 7

 Equipment 11

Description 13

Contents 14

Assembly 15

 Power Head Shaft/Lower Shaft Assembly 15

 Support Handle Removal 16

Operation 16

 Adjusting Cutting Angle 16

 Rotate Cutter Assembly 18

 Hedge Trimming 18

Maintenance 20

 Skill Levels 20

 Maintenance Intervals 20

 Lubrication 21

 Blades 23

Storage 26

 Storage Hook Installation 26

Specifications 27

Product Registration 28

INTRODUCTION

Welcome to the ECHO family. This ECHO product was designed and manufactured to provide long life and on-the-job dependability. Read and understand this manual and the SAFETY MANUAL. You will find both easy to use and full of helpful operating tips and SAFETY messages.

The Operator's Manual

Keep it in a safe place for future reference. Contains specifications and information for safety, operation, maintenance, storage and assembly specific to this product. Scan QR codes throughout the operator's manual for more information.

The Safety Manual

Keep it in a safe place for future reference. Explains possible hazards and the measures you should take to insure safe operation.

SERVICING INFORMATION

Parts/Serial Number

Genuine ECHO Parts, assemblies and maintenance kits for your ECHO products are available from an Authorized ECHO Dealer. When you do need to buy parts **always** have the Model Number and Serial Number of the unit with you. You can find these numbers on the engine housing. For future reference, write them in the space provided below.

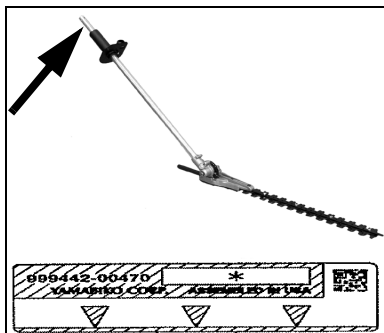

Model No. _____ Serial No. _____

Service

Service of this product during the warranty period must be performed by an Authorized ECHO Service Dealer. For the name and address of the Authorized ECHO Service Dealer nearest you, ask your retailer or call: 1-800-432-ECHO (3246). Dealer information is also available on our Web Site. When presenting your unit for Warranty service/repairs, proof of purchase is required.

Echo Consumer Product Support

If you require assistance or have questions concerning the application, operation or maintenance of this product you may call the ECHO Consumer Product Support Department at 1-800-673-1558 from 8:00 am to 5:00 pm (Central Standard Time) Monday through Friday. Before calling, please know the model and serial number of your unit.

Product Registration

To ensure trouble free warranty coverage it is important that you register your ECHO equipment on-line at www.echo-usa.com or by filling out the product registration sheet included in this manual. Registering your product confirms your warranty coverage and provides a direct link between you and ECHO if we find it necessary to contact you.

Additional or Replacement Manuals

Replacement Operator, Safety Manuals, and Parts Catalogs are available from your ECHO dealer or at www.echo-usa.com or by contacting ECHO Inc., 400 Oakwood Road, Lake Zurich, IL 60047 (800-673-1558). Always check the ECHO Web Site for updated information.



Safety Videos are available from your Echo dealer. A \$5.00 shipping charge will be required for each video.

SAFETY

WARNING

Refer to your Pro Attachment Series or Split Boom Operator's Manual for correct engine fueling, starting and stopping instructions.

Manual Safety Symbols and Important Information

Throughout this manual and on the product itself, you will find safety alerts and helpful, informational messages preceded by symbols or key words. The following is an explanation of those symbols and key words and what they mean to you.

DANGER

The safety alert symbol accompanied by the word “DANGER” calls attention to an act or condition which WILL lead to serious personal injury or death if not avoided.

WARNING

The safety alert symbol accompanied by the word “WARNING” calls attention to an act or condition which CAN lead to serious personal injury or death if not avoided.

CAUTION

The safety alert symbol accompanied by the word “CAUTION” calls attention to an act or condition which may lead to minor or moderate personal injury if not avoided.

NOTICE

The enclosed message provides information necessary for the protection of the unit.



Note: This enclosed message provides tips for use, care and maintenance of the unit.

















CIRCLE AND SLASH SYMBOL

This symbol means the specific action shown is prohibited. Ignoring these prohibitions can result in serious or fatal injury.

International Symbols

Symbol	Description	Symbol	Description
	Warning, See Operator's Manual		Safety/Alert

Symbol	Description	Symbol	Description
	Wear eye, ear and head protection		Finger Severing
	Wear hand and foot protection		Rotating Cutting Attachment
	Wear Face Shield		Wear slip resistant foot wear
	Keep feet away from blade		Do not operate closer than 15 M (50 ft.) from electrical hazards. Keep bystanders at least 15 meters (50 feet) away
	DO NOT USE BLADES - Line Head Only		Thrown objects
	Plan retreat path from falling objects		Hot Surface
		<p>AVOID KICKOUT. Keep bystanders at least 15 meters (50 feet) away.</p> <p>Beware Thrown Objects Wear Eye Protection</p>	
		<p>Keep bystanders and helpers away 15 m (50 ft.).</p>	

Personal Condition and Safety Equipment

WARNING

Users of this product risk injury to themselves and others if the unit is used improperly and/or safety precautions are not followed. Proper clothing and safety gear must be worn when operating unit.

Physical Condition

Your judgment and physical dexterity may not be good:

- If you are tired or sick.
- If you are taking medication.
- If you have taken alcohol or drugs.

Operate unit only if you are physically and mentally well.

Eye Protection

WARNING

- ◆ **Eye protection that meets ANSI Z87.1 or CE requirements must be worn whenever you operate the unit.**
- ◆ **For additional safety, a full-face shield may be worn over safety glasses or goggles to provide protection from sharp branches or flying debris.**

Hand Protection

Wear sturdy, no-slip, rubber work gloves to improve your grip on the handles. Gloves also provide protection against cuts and scratches, cold environments, and reduce the transmission of machine vibration to your hands.

Hearing/Ear Protection

ECHO recommends wearing hearing protection whenever unit is used.

Breathing Protection

Operators who are sensitive to dust or other common airborne allergens may need to wear a dust mask to prevent inhaling these materials while operating unit. Dust masks can provide protection against dust, plant debris, and other plant matter such as pollen. Make sure the mask does not impair your vision, and replace the mask as needed to prevent air restrictions.

Proper Clothing

Wear snug-fitting, durable clothing:

- Pants should have long legs, shirts should have long sleeves.
- DO NOT WEAR SHORTS.
- DO NOT WEAR TIES, SCARVES, JEWELRY, or clothing with loose or hanging items that could become entangled in moving parts or surrounding growth.
- Keep clothing buttoned or zipped, and keep shirt tails tucked in.

Wear sturdy work shoes with nonskid rubber soles:

- DO NOT WEAR OPEN TOED SHOES.
- DO NOT OPERATE UNIT BAREFOOTED.

Keep long hair away from engine and air intake. Retain hair with cap or net.

Heavy protective clothing can increase operator fatigue, which may lead to heat stroke. Schedule heavy work for early morning or late afternoon hours when temperatures are cooler.

WARNING

The components of this machine generate an electromagnetic field during operation, which may interfere with some pacemakers. To reduce the risk of serious or fatal injury, persons with pacemakers should consult with their physician and the pacemaker manufacturer before operating this machine. In the absence of such information, ECHO does not recommend the use of this machine by anyone who has a pacemaker.

Extended Operation / Extreme Conditions

CAUTION

Prolonged exposure to cold and/or vibration may result in injury. Read and follow all safety and operation instructions to minimize risk of injury. Failure to follow instructions may result in painful wrist/hand/arm injuries.

It is believed that a condition called Raynaud's Phenomenon, which affects the fingers of certain individuals, may be brought about by exposure to vibration and cold. Exposure to vibration and cold may cause tingling and burning sensations, followed by loss of color and numbness in the fingers. The following precautions are strongly recommended, because the minimum exposure, which might trigger the ailment, is unknown.

- Keep your body warm, especially the head, neck, feet, ankles, hands, and wrists.
- Maintain good blood circulation by performing vigorous arm exercises during frequent work breaks, and also by not smoking.
- Limit the hours of operation. Try to fill each day with jobs where operating the unit or other hand-held power equipment is not required.
- If you experience discomfort, redness, and swelling of the fingers followed by whitening and loss of feeling, consult your physician before further exposing yourself to cold and vibration.

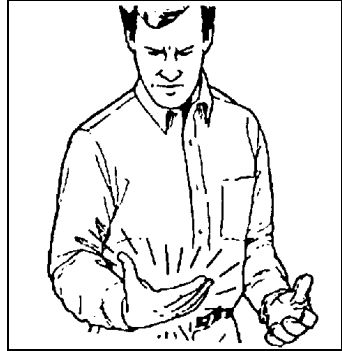

Repetitive Stress Injuries (RSI)

It is believed that overusing the muscles and tendons of the fingers, hands, arms, and shoulders may cause soreness, swelling, numbness, weakness, and extreme pain in those areas. Certain repetitive hand activities may put you at a high risk for developing a Repetitive Stress Injury (RSI). An extreme RSI condition is Carpal Tunnel Syndrome (CTS), which could occur when your wrist swells and squeezes a vital nerve that runs through the area. Some believe that prolonged exposure to vibration may contribute to CTS. CTS can cause severe pain for months or even years.



To reduce the risk of RSI/CTS, do the following:

- Avoid using your wrist in a bent, extended, or twisted position. Instead try to maintain a straight wrist position. Also, when grasping, use your whole hand, not just the thumb and index finger.
- Take periodic breaks to minimize repetition and rest your hands.

- Reduce the speed and force with which you do the repetitive movement.
- Do exercises to strengthen the hand and arm muscles.
- Immediately stop using all power equipment and consult a doctor if you feel tingling, numbness, or pain in the fingers, hands, wrists, or arms. The sooner RSI/CTS is diagnosed, the more likely permanent nerve and muscle damage can be prevented.

DANGER

All over head electrical conductors and communications wires can have electricity flow with high voltages. This unit is not insulated against electrical current. Never touch wires directly or indirectly, otherwise serious injury or death may result.

DANGER

Do not operate this product indoors or in inadequately ventilated areas. Engine exhaust contains poisonous emissions and can cause serious injury or death.

Read the Manuals

- Provide all users of this equipment with the Operator's Manual and Safety Manual for instructions on Safe Operation.

Clear the Work Area

- Spectators and fellow workers must be warned, and children and animals prevented from coming nearer than 15 m (50 ft.) while the unit is in use.

Keep a Firm Grip

- Always hold throttle handle and support handle with thumbs and fingers tightly encircling the handles.

Keep a Solid Stance

- Maintain footing and balance at all times. Do not stand on slippery, uneven or unstable surfaces. Do not work in odd positions or on ladders. Do not over reach.

Cutting Angle Adjustments

- Only adjust cutting blade angle with unit flat on the ground, with the engine stop switch in the "STOP" position. Never adjust cutting angle with unit standing upright.

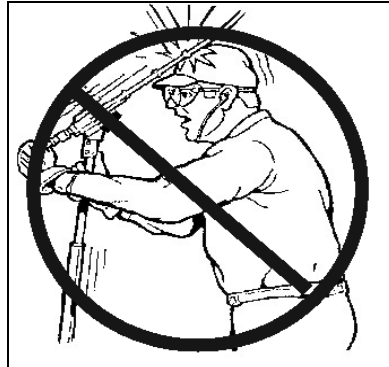

Avoid Contact With Gear Box Assembly During Use

- Gear box assembly becomes hot during use. Avoid contact with gear box assembly when using unit or making cutting angle adjustments.



Avoid Hot Surfaces

- Keep exhaust area clear of flammable debris. Avoid contact during and immediately after operation.



WARNING

Never perform blade maintenance procedures while engine is running.

Equipment

WARNING

Use this attachment with ECHO approved models only. Serious injury may result from the use of this attachment combined with a non approved ECHO product.

- Check unit for loose/missing nuts, bolts, and screws. Tighten and/or replace as needed.
- Never adjust blades when the engine is operating.

- Inspect hand guard for damage. Replace if damaged or missing.
- Check that the blade assembly is firmly attached and in safe operating condition. Dull, loose or damaged blades should not be used.

Note: ECHO, INC. will not be responsible for the failure of cutting devices, attachments or accessories which have not been tested and approved by ECHO.

WARNING

***Moving parts can amputate fingers or cause severe injuries.
Keep hands, clothing and loose objects away from all openings.***

- ◆ *ALWAYS stop engine, disconnect spark plug, and make sure all moving parts have come to a complete stop before removing obstructions, clearing debris, or servicing unit.*
- ◆ *DO NOT start or operate unit unless all guards and protective covers are properly assembled to unit.*
- ◆ *NEVER reach into any opening while the engine is running. Moving parts may not be visible through openings.*

DESCRIPTION

Locate the safety decal(s) on your unit. Make sure the decal(s) is legible and that you understand and follow the instructions on it. If a decal cannot be read, a new one can be ordered from your ECHO dealer.

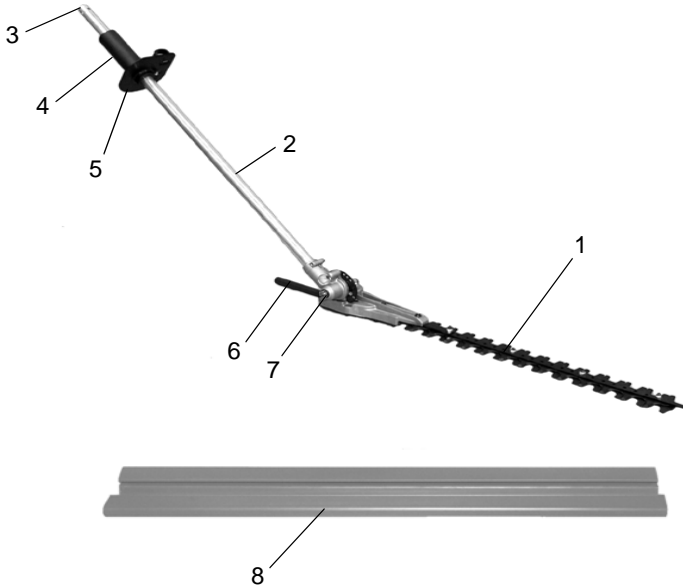

Shaft Label

	<p>PELIGRO</p> <p>Este producto puede ser peligroso si se utiliza incorrectamente. Lea detenidamente el manual de instrucciones antes de utilizarlo. Este producto puede ser peligroso si se utiliza incorrectamente. Lea detenidamente el manual de instrucciones antes de utilizarlo.</p>	<p>⚠ DANGER</p> <p>This unit can be dangerous and cause serious injury or death if it is not used properly. Read the operator's manual and safety manual carefully before using this unit. This unit can be dangerous and cause serious injury or death if it is not used properly. Read the operator's manual and safety manual carefully before using this unit.</p>	<p>⚠ DANGER</p> <p>This unit can be dangerous and cause serious injury or death if it is not used properly. Read the operator's manual and safety manual carefully before using this unit. This unit can be dangerous and cause serious injury or death if it is not used properly. Read the operator's manual and safety manual carefully before using this unit.</p>
--	--	---	---

1. **CUTTING BLADES** - Double reciprocating blades mounted to a blade support bar. Double sided blades, are capable of cutting on either side of the blade.
2. **LOWER DRIVE SHAFT ASSEMBLY** - Includes the Gear Housing assembly, Flexible Drive Cable, Blade and Safety Decals.
3. **FLEXIBLE DRIVE CABLE** - Cable end fits into upper drive shaft coupler. Lubricate drive cable every 25 hours with POWER BLENDX™ grease.
4. **SUPPORT HANDLE - FOR LEFT HAND** - Grip for Left Hand.
5. **HAND GUARD / BLADE LOCK** - Locks blade in place for travel / storage. Always assure blade cover is installed when locking blade.
6. **BLADE ADJUSTMENT HANDLE** - Provides secure hand grip for adjusting cutting blade angle.
7. **BLADE INDEXING RING** - Pull ring out and turn 1/4 turn to lockout position when adjusting blade angle.
8. **BLADE COVER** - Used to cover blades during transport and storage. Remove blade cover before operating unit.

CONTENTS

The ECHO product you purchased has been factory pre-assembled for your convenience. Due to packaging restrictions, some assembly may be necessary.

After opening the carton, check for damage. Immediately notify your retailer or ECHO Dealer of damaged or missing parts. Use the contents list to check for missing parts.

- ___ Articulating Hedge Clipper Attachment
- ___ Operator's Manual
- ___ Safety Manual
- ___ Blade Cover
- ___ Storage Hook Assembly



ASSEMBLY

Power Head Shaft/Lower Shaft Assembly



Do not perform maintenance or assembly procedures with engine running.

Parts Required: PAS or SRM-SB Power Head w/Shaft & Coupling



1. Set Power Head/Shaft Assembly on a level surface.
2. Pull locator pin (A) out, and turn counter-clockwise ¼ turn to lock-out position.
3. Remove vinyl cap from attachment drive shaft.
4. Remove cardboard spacer, if necessary.
5. Carefully fit attachment drive shaft assembly into coupler (B) to decal assembly line (C), making sure that the inner lower drive shaft engages the square upper drive shaft socket.

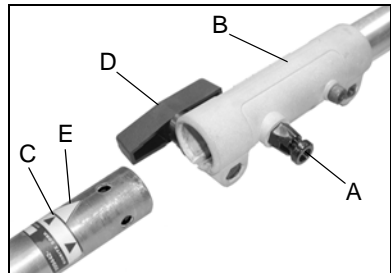

Note: Earlier model Power Heads may have shorter couplings. Short couplings fit flush to decal point (E). New couplings are 4 ¾ in. long, and fit flush to line (C).

Note: Lower bearing housing and head assembly must be in line with the engine.

6. Rotate locator pin (A) ¼ turn clockwise to engage lower shaft hole. Insure locator pin is fully engaged by twisting lower drive shaft. Locator pin should snap flush in coupler. Full engagement will prevent further shaft rotation.
7. Secure lower shaft assembly to coupler by tightening clamping knob (D).

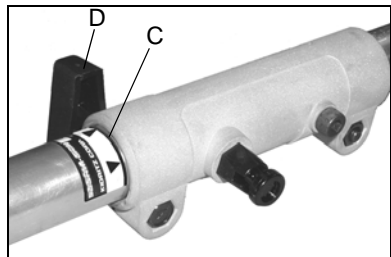

Support Handle Removal

Note: Support handles or support handles with barrier bars are not recommended for use with this attachment.

1. Remove support handle assembly, barrier bar (if installed), and mounting hardware from PAS or SRM-SB power head.
2. Retain parts for future use.



OPERATION

Note: Refer to your PAS power source Operator's Manuals for correct engine fueling, starting and stopping instructions.

WARNING

Moving parts can amputate fingers or cause severe injuries. Keep hands, clothing and loose objects away from all openings. Always stop engine, disconnect spark plug, and make sure all moving parts have come to a complete stop before removing obstructions, clearing debris, or servicing unit. Allow unit to cool before performing service.

Adjusting Cutting Angle

WARNING

Never adjust cutting assembly with engine running.

WARNING

Hedge Trimmer blades are sharp. Always wear gloves when adjusting cutting assembly.

WARNING

DO NOT stand hedge trimmer on end when adjusting cutting angle, otherwise serious injury may result.

1. Place unit on a flat clear area. Assure stop switch is in the "STOP" position.
2. Pull out indexing ring (A), and turn ¼ turn to lockout position.



3. Turn hedge trimmer ¼ turn so that indexing ring faces downward.

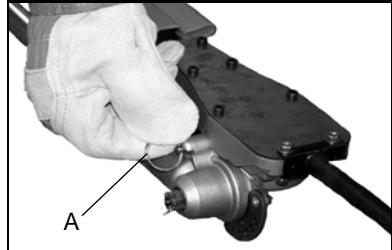

4. Release hand-guard blade lock (B) with right hand, while holding blade-adjustment handle (C) with left hand.
5. Rotate blades to desired cutting position.
6. Turn indexing ring ¼ turn to lock blade in place.

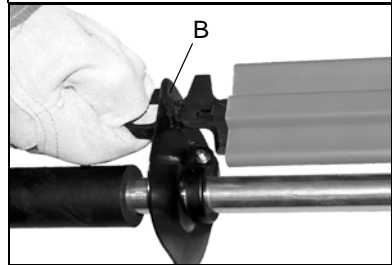

! WARNING

Gear case assembly becomes HOT during use. Always grip assembly at blade-adjustment handle when making cutting angle adjustments, otherwise serious injury may result.

Rotate Cutter Assembly

Always use the unit from the right-hand side of your body – NEVER from the left side. Rotate cutter assembly 180 degrees on driveshaft in order to avoid cutting directly above your head, and to avoid contact with hot muffler.

1. Loosen gearcase clamping screw (A), hand guard clamping screw (B), and remove gearcase locating screw (C).
2. Rotate cutter assembly 180-degrees on driveshaft until locating hole in driveshaft is visible through locating hole in gearcase.
3. Install gearcase locating screw (C), and securely tighten all hardware.

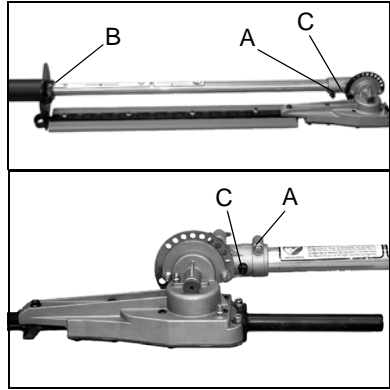

WARNING

Hedge Trimmer blades are very sharp. Wear gloves to protect hands when rotating cutter assembly or serious personal injury may result.

WARNING

During operation, the complete unit, especially the drive shaft housing and gearcase may become too hot to touch. Avoid contact when rotating cutter assembly.

Hedge Trimming

WARNING

Engine exhaust IS HOT, and contains Carbon Monoxide (CO), a poison gas. Breathing CO can cause unconsciousness, serious injury, or death. Exhaust can cause serious burns. ALWAYS position unit so that exhaust is directed away from your face and body.

! WARNING

Hedge Trimmer blades are very sharp. Touching them may lead to severe personal injury. Avoid touching blades whenever possible, and always wear gloves to protect hands.

- 1. Always grip throttle handle with right hand and support handle with left hand.
- 2. Hold trimmer firmly and squeeze throttle trigger to accelerate engine.
- 3. Tilt trimmer so cutting teeth are angled slightly toward the hedge or shrub and proceed to cut.

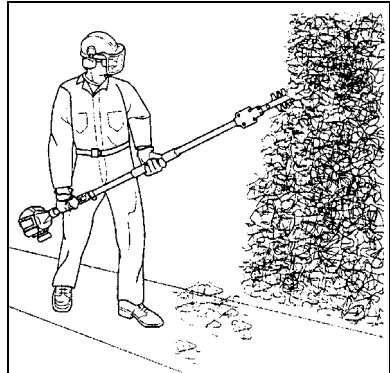

! WARNING

Never remove hands from unit when blades are moving.

! WARNING

The engine continues running even when the blades have stopped due to an obstruction. If this occurs, stop the engine, disconnect ignition cable and remove the obstruction.

MAINTENANCE

WARNING

Moving parts can amputate fingers or cause severe injuries. Keep hands, clothing and loose objects away from all openings. Always stop engine, disconnect spark plug, and make sure all moving parts have come to a complete stop before removing obstructions, clearing debris, or servicing unit. Allow unit to cool before performing service. Wear gloves to protect hands from sharp edges and hot surfaces.

Your ECHO unit is designed to provide many hours of trouble free service. Regular scheduled maintenance will help your unit achieve that goal. If you are unsure or are not equipped with the necessary tools, we recommend that you take your unit to an ECHO Servicing Dealer for maintenance. To help you decide whether you want to DO-IT-YOURSELF or have the ECHO Dealer do it, each maintenance task has been graded. If the task is not listed, see your ECHO Dealer for repairs.

Skill Levels

Level 1 = Easy to do. Common tools may be required.

Level 2 = Moderate difficulty. Some specialized tools may be required.

Click [HERE](#) or go to <http://www.echo-usa.com/products/maintenance-kit> for information on Maintenance Kits

Maintenance Intervals

Component/ System	Maintenance Procedure	Skill Level	Interval
Drive Shaft	Grease	1	Every 25 hours of use [1]
Gear Housing	Grease	1	Every 15-25 hours of use [1]
Blades	Lubrication	1	Every 15-25 hours of use
Blades	Sharpen	2	As needed
Blades	Adjust	2	Every 40 hours of use
Screws/Nuts/Bolts	Inspect/ Tighten/ Replace	1	Before Each Use

IMPORTANT - Time intervals shown are maximum. Actual use and your experience will determine the frequency of required maintenance.

(1) Apply lithium based grease.

Lubrication

Blades

Level 1.

Parts Required: 20W Engine Oil (blade lubrication), 50-50 mixture of kerosene and 20W oil (blade cleaning)

WARNING

Hedge Clipper blades are very sharp. Touching them may lead to severe personal injury. Avoid touching blades whenever possible, and always wear gloves to protect hands.

1. Brush loose debris from blade and coat both sides of blade with the 50-50 cleaning mixture.
2. Allow cleaning mixture to soften the remaining gummy residue then wipe it from the blade.
3. Apply clean oil to the entire length of the blade. Be certain the blade bolts are lubricated.
4. Wipe excess oil from the blade before putting the unit back in service.

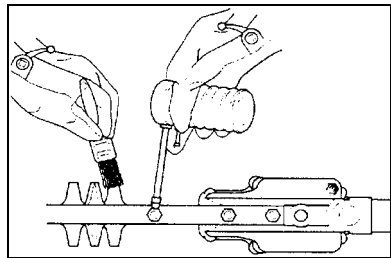

Gear Case

Level 1.

Parts Required: Lithium Base Grease.

1. Clean dirt from grease fittings (A).

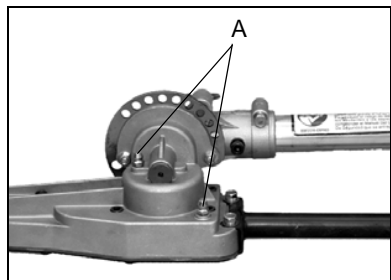

2. Carefully pump grease into fittings (A). DO NOT force grease. Too much pressure will force grease past seals and cause damage. Apply 1-2 pumps of grease every 15-25 hours of operation.
3. Wipe excess grease from around grease fitting.



Drive Shaft Assembly

Level 1.

Parts Required: Lithium Base Grease.

⚠ WARNING

Hedge Clipper blades are very sharp. Touching them may lead to severe personal injury. Avoid touching blades whenever possible, and always wear gloves to protect hands.

1. Carefully remove locating screw (A) and loosen clamping screw (B). Remove the flex drive shaft assembly from the gear housing.

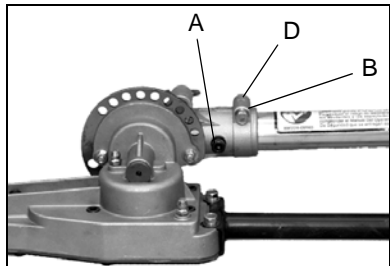

2. Pull the drive shaft (C) from the drive shaft assembly, and wipe clean. Re-coat with a thin coating [½ oz. (15 ml)] of grease.
3. Slide the flex shaft back into the drive shaft assembly, being careful not to get dirt on the flex shaft.

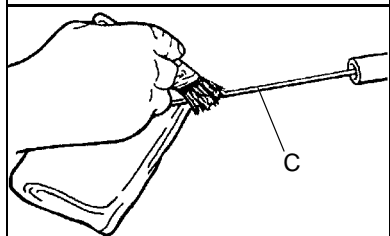

- Align the locating screw hole in gear case with the locating hole in drive shaft assembly, install and tighten locating screw (A), and tighten clamping screw (B).

NOTICE

Flat edge of washers (D) must be against drive shaft.

Blades

NOTICE

Blades should only be removed and reinstalled by an Authorized ECHO Servicing Dealer, otherwise premature wear or internal damage may occur.

Sharpening

Level 2.

Parts Required: None

! WARNING

Hedge Trimmer blades are very sharp. Touching them may lead to severe personal injury. Avoid touching blades whenever possible, and always wear gloves to protect hands.

- Move stop switch to STOP position.
- Disconnect spark plug wire.
- Remove blade guard, if installed (see "Blade Guard Remove/Install instructions").
- Slide blades to allow file clearance using slots (A) on bottom of blade. Do not pry against cutting edges.

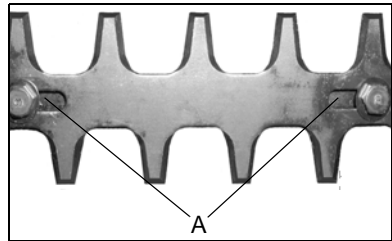

- File each edge carefully. Follow the original shape of the blade.

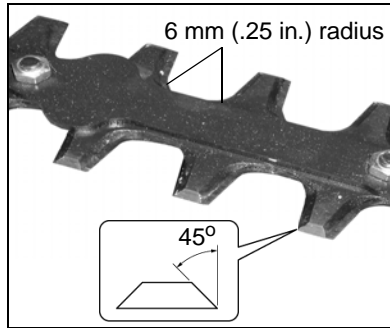

NOTICE

If a power grinder is used DO NOT allow blade to over heat.

- Install blade guard, if necessary (see "Blade Guard Remove/Install instructions").
- Lubricate blades (see "Lubrication").
- Connect spark plug wire.

Adjustment

Level 2.

Parts Required: None

! WARNING

Hedge Trimmer blades are very sharp. Touching them may lead to severe personal injury. Use long hex wrenches and sockets with extensions when tightening blade screws and blade lock nuts to keep hands at a safe distance from sharp blades.

- Tighten blade screws securely.



- 2. Hold blade screws (A) to prevent turning, and tighten lock nuts (B).

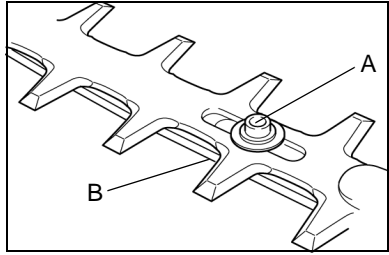

NOTICE

Locking ability of Hedge Trimmer blade lock nuts will diminish each time they are removed. Replace if turning resistance is not felt when installing lock nuts.

STORAGE

NOTICE

Always store and transport hedge clippers in a stable position. Support gear case and cutting blades to prevent excessive flexing which may cause damage to the cutting attachment. Always install blade cover when transporting or storing unit.

1. Clean and lubricate cutting blades and gear case.
2. Sharpen cutting blades as required.
3. Apply a light coating of clean 20W engine oil along entire length of blades and on blade bolts.
4. Install blade cover onto hedge clipper cutting blades.
5. Store hedge clipper attachment in a dry, dust free place out of the reach of children, using supplied storage hook.

Storage Hook Installation

1. Insert small end of hook into locating hole on attachment shaft.
2. Slide plastic cap onto end of attachment shaft.

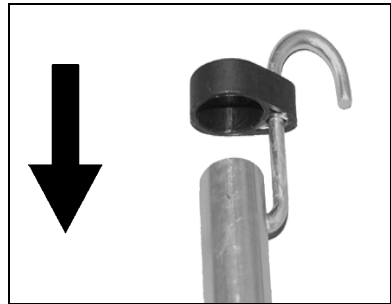

SPECIFICATIONS

MODEL	99944200595
Length	1016 mm (40.0 in.)
Attachment Width	132 mm (5.2 in.)
Attachment Height	127 mm (5.0 in.)
Weight	2.76 kg (6.08 lb.)
Gear Case Ratio	4.072:1
Cutter	Double Reciprocating Blade - Double Edge
Effective Length	464 mm (18.3 in.)
Pitch	35 mm (1.4 in.)
Maximum Diameter Cut	
Soft Material	25.4 mm (1 in.)
Woody Material	13 mm (½ in.)

PRODUCT REGISTRATION

Thank you for choosing ECHO Power Equipment

Please go to <http://www.echo-usa.com/Warranty/Register-Your-ECHO> to register your new product on-line. It's **FAST** and **EASY!** NOTE: your information will never be sold or misused by ECHO, Inc. Registering your purchase enables us to contact you in the unlikely event of a service update or product recall, and verifies your ownership for warranty consideration.

If you do not have access to the Internet, you can complete the form below and mail to:

ECHO Inc., Product Registration, PO Box 1139, Lake Zurich IL 60047.



PRODUCT REGISTRATION CARD : TARJETA DE REGISTRO : CARTE D'ENREGISTREMENT DU PRODUIT

ONLINE OPTION: Register online and save a stamp! You will be alerted of product updates and/or be sent new ECHO product information and special offers. Simply go to: www.echo-usa.com

OPCIÓN POR INTERNET: Regístrese en la página web y ahorre una estampilla! Le alertarán sobre actualizaciones del producto y/o se le enviara información sobre los nuevos productos ECHO y las ofertas especiales. Simplemente visite: www.echo-usa.com

OPTION EN LIGNE: Enregistrer en ligne et épargner un timbre! Vous serez informé sur les nouveaux produits ECHO et les offres spéciales. Simplement visitez le: www.echo-usa.com

Please Print : Por Favor Escriba con Letra De Molde : En Lettre Carré S.V.P.

Confidential: Information provided will not be shared or sold

Purchaser's Name : Nombre del Comprador : Nom de l'acheteur	
Address : Dirección : Adresse	
City : Ciudad : Ville	State - Estado : Zip Code - Código Postal : Code Postal Province
E-Mail Address : Dirección De Correo Electrónico : Courrier Électronique	
Phone Number : Número De Teléfono : Téléphone	Date of Purchase : Fecha de la Compra : Date de l'achat
Where Purchased : Nombre del Almacén donde fue Comprado : Lieu d'achat	
Model Number : Numero del Modelo : No. de modèle	Serial Number : Numero de Serie : No. de série

Registering your purchase enables us to contact you in the unlikely event of a service update or product recall and verifies your purchase. En registrar su compra, nos permite contactarlo en caso de un servicio de actualización o un llamado de atención. L'enregistrement de votre achat nous permet de vous contacter dans le cas improbable de modifications des instructions d'entretien ou de rappel du produit et vérifie que vous êtes le propriétaire en cas de vol ou de perte.

Primary use of tool: Professional Homeowner Rental/Equip.
 Uso primario de la herramienta: Profesional Dueño de casa Alquiler
 Usage principal : Professionnel Résidentiel Location
 Do you wish to receive periodic ECHO product information and special offers by e-mail? Yes No
 ¿Desea usted recibir información periódica y ofertas especiales por correo electrónico sobre el producto ECHO? Yes No
 Souhaitez-vous recevoir périodiquement de l'information sur les produits ECHO et les offres spéciales par courrier électronique ? Oui Non

Did you visit the ECHO website before purchasing your product?
 Yes No
 Visité usted la página web ECHO antes de comprar su producto?
 Si No
 Avez-vous visité le site d'ECHO avant de procurer votre produit?
 Oui Non

What factor(s) most influenced your purchase?
 Performance Price Dealer
 Reliability Prior Experience Quality Warranty
 Friend/Family Brand Warrantly
 ¿Qué factor(es) influenció más en su compra?
 Funcionamiento Precio Distribuidor
 Confiabilidad Experiencia Anterior Calidad Garantía
 Amigo/Familia Marca Garantía

Quel facteur (facteurs) vous a influencé le plus?
 Performance Prix Marchand
 Fiabilité Expérience Qualité
 Ami/Famille Marque Garantie

ECHO INC., 400 Oakwood Rd., Lake Zurich, IL 60047
 1.800.432.ECHO WWW.ECHOUSA.COM



Notes

Notes

S06700001001/S06700999999



ECHO, INCORPORATED

400 Oakwood Road
Lake Zurich, IL 60047

www.echo-usa.com