



Grass Trimmer/Brush Cutter

Operator's Manual

MODEL **SRM - 230**
 SRM - 230S

WARNING **DANGER**



The muffler or catalytic muffler and surrounding cover may become extremely hot.



Always keep clear of exhaust and muffler area, otherwise serious personal injury may occur.



WARNING



The engine exhaust from this product contains chemicals known to the State of California to cause cancer, birth defects or other reproductive harm.



WARNING **DANGER**

Read rules for safe operation and instructions carefully. ECHO provides an Operator's Manual and a Safety Manual. Both must be read and understood for proper and safe operation.

INTRODUCTION

Welcome to the ECHO family. This ECHO product was designed and manufactured to provide long life and on-the-job dependability. Read and understand this manual and the SAFETY MANUAL you found in the same package. You will find both easy to use and full of helpful operating tips and SAFETY messages.

THE OPERATOR'S MANUAL

Read and understand this manual before operation. Keep it in a safe place for future reference. It contains specifications and information for operation, starting, stopping, maintenance, storage and assembly specific to this product.

THE SAFETY MANUAL

Read and understand this manual before operation. Keep it in a safe place for future reference. It explains possible hazards involved with the use of Grass Trimmers and Brush Cutters and what measures you should take to make their use safer.

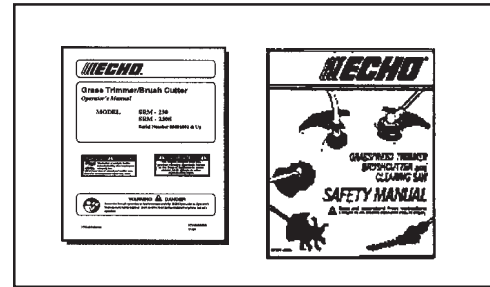

TABLE OF CONTENTS

Introduction	2	Operation	16
- The Operator's Manual	2	- Starting Cold Engine	16
- The Safety manual	2	- Starting Warm Engine	17
Manual Safety Symbols and Important Information	3	- Stopping Engine	17
Safety	3	Maintenance	18
- Decals	3	- Skill Levels	18
- International Symbols	4	- Maintenance Intervals	18
Safety Instructions	5	- Air Filter	19
- Personal Condition and Safety Equipment	5	- Fuel Filter	19
- Extended Operation/Extreme Conditions	5	- Spark Plug	20
- Equipment	6	- Cooling System Cleaning	20
- Safe Operation	7	- Exhaust System	21
Emission Control	7	- Carburetor Adjustment Emission	22
Description	8	- Lubrication	23
- Contents	8	- Nylon Line Replacement	24
Specifications	10	- Sharpening Metal Blades	25
Assembly	11	Troubleshooting	26
- Plastic Shield Installation	11	Storage	27
- Nylon Line Head Installation	11	Servicing Information	28
- Front Handle Installation	12	- Parts	28
Pre-Operation	12	- Service	28
- Operation with Blades	12	- ECHO Consumer Product Support	28
- Fuel	15	- Warranty Card	28
		- Additional or Replacement Manuals	28

Specifications, descriptions and illustrative material in this literature are as accurate as known at the time of publication, but are subject to change without notice. Illustrations may include optional equipment and accessories, and may not include all standard equipment.

MANUAL SAFETY SYMBOLS AND IMPORTANT INFORMATION

Throughout this manual and on the product itself, you will find safety alerts and helpful, informational messages preceded by symbols or key words. The following is an explanation of those symbols and key words and what they mean to you.



This symbol accompanied by the words **WARNING** and **DANGER** calls attention to an act or condition that can lead to serious personal injury to operator and bystanders.



The circle with the slash symbol means whatever is shown within the circle is prohibited.



IMPORTANT The enclosed message provides information necessary for the protection of the unit.

NOTE This enclosed message provides tips for use, care and maintenance of the unit.

SAFETY

DECALS

Locate these safety decals on your unit. Make sure the decals are legible and that you understand and follow the instructions on them. If a decal cannot be read, a new one can be ordered from your ECHO dealer. See PARTS ORDERING instructions for specific information.

Hot Decal (near muffler)

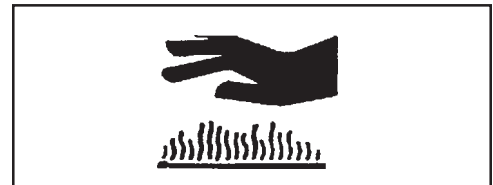

P/N 89016006361

Shaft Decal

Spanish Decal



89022890560

ADVERTENCIA  **PELIGRO**

Esta unidad puede ser peligrosa y producir lesiones personales graves si no se usa en forma adecuada. Para reducir el riesgo de lesionarse, los operadores, los ayudantes y los espectadores deben leer y comprender el Manual Del Operador y los Manuales De Seguridad que se entregan escritos en español.

P/N 89022890560

English Translation

WARNING  **DANGER**

This unit can be dangerous and cause serious injury if improperly used. To reduce injury risk to operator, helpers and bystanders, read and understand the Operator's and Safety Manuals, which are provided in Spanish.

Shaft Decal

P/N 89016844830



- This unit can be dangerous and cause serious injury if improperly used. To reduce injury risk to operator, helpers, and bystanders, read and understand the Operator's and Safety manuals.
- Blindness can occur from objects that are thrown or ricocheted even with shield in place. Operators, helpers, and bystanders must wear ANSI Z87.1 approved eye protection.
- Always wear hearing protection when operating unit.
- Prevent accidental contact with unit and any cutting attachment. Maintain a 15M (50 ft.) radius, **DANGER ZONE** surrounding the operator. **ONLY** the operator, dressed in proper protective clothing should be in the **DANGER ZONE**.
- Beware of **KICKOUT (blade thrust)** when using blades. Special precautions are necessary for blade operation, see your Operator's and Safety Manuals. **ONLY** install ECHO approved blades on Brush Cutters (SRM) models equipped with proper blade shield, U-handles, harness, blade collar, nut and cotter pin.
- Blade/Cutting attachment does not stop immediately after releasing throttle. Keep hands and feet clear of blade/cutting attachment unless engine is shut off and cutting attachment is not moving.
- **INSPECT BLADES BEFORE USE.**
- **DO NOT USE DAMAGED, CRACKED, BENT, DULL OR IMPROPERLY SHARPENED BLADES.**
- Do not remove shields, modify the unit or install attachments or parts not approved by ECHO. Approved attachment information and replacement Operator's and Safety Manuals are available from your ECHO dealer or by writing: **ECHO, INCORPORATED, 400 OAKWOOD RD., LAKE ZURICH, IL 60047.**

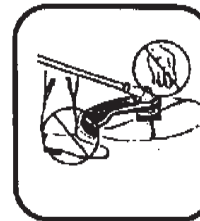
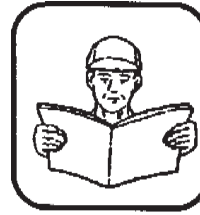

INTERNATIONAL SYMBOLS

SYMBOL	DESCRIPTION	SYMBOL	DESCRIPTION
	WARNING, SEE OPERATOR'S MANUAL		Hot Surface
	Wear eye, ear and head protection		Finger Severing
	Wear hand and foot protection		DO NOT allow flames or sparks near fuel.
	Safety/Alert		DO NOT smoke near fuel.
	Keep bystanders and helpers away 15 m (50ft.).		

SYMBOL	DESCRIPTION	SYMBOL	DESCRIPTION
	Emergency Stop		Fuel and oil mixture
	Carburetor Adjustment - High speed mixture		Primer Bulb
	Carburetor Adjustment - Idle speed		Ignition ON/OFF
	Carburetor Adjustment - Low speed mixture		Do not use blades. String line only
	Choke Control "Run" Position (Choke Open)		Choke Control "Cold Start" Position (Choke Closed)

SAFETY INSTRUCTIONS

PERSONAL CONDITION AND SAFETY EQUIPMENT

WARNING DANGER

Trimmer/Brush Cutter users risk injury to themselves and others if the trimmer/brush cutter is used improperly or safety precautions are not followed. Proper clothing and safety gear must be worn when operating a trimmer/brush cutter.

Physical Condition

Your judgment and physical dexterity may not be good:

- if you are tired or sick,
- if you are taking medication,
- if you have taken alcohol or drugs.

Operate unit only if you are physically and mentally well.

Eye Protection

Wear eye protection that meets ANSI Z87.1 or CE requirements whenever you operate the unit.

Hand Protection

Wear no-slip, heavy duty work gloves to improve your grip on the unit handles. Gloves also reduce the transmission of machine vibration to your hands.

Hearing Protection

ECHO recommends wearing hearing protection whenever unit is used.

Proper Clothing

Wear snug fitting, durable clothing;

- Pants should have long legs, shirts with long sleeves.
- DONOTWEARSHORTS,
- DONOTWEARTIES,SCARVES,JEWELRY.

Wear sturdy work shoes with non-skid soles;

- DONOTWEAROPENTOEDSHOES,
- DONOTOPERATEUNITBAREFOOTED.

Hot Humid Weather

Heavy protective clothing can increase operator fatigue which may lead to heat stroke. Schedule heavy work for early morning or late afternoon hours when temperatures are cooler.

EXTENDED OPERATION/EXTREME CONDITIONS

Vibration and Cold

It is believed that a condition called Raynaud's Phenomenon, which affects the fingers of certain individuals, may be brought about by exposure to vibration and cold. Exposure to vibration and cold may cause tingling and burning sensations, followed by loss of color and numbness in the fingers. The following precautions are strongly recommended, because the minimum exposure which might trigger the ailment is unknown.

- Keep your body warm, especially the head, neck, feet, ankles, hands, and wrists.
- Maintain good blood circulation by performing vigorous arm exercises during frequent work breaks, and also by not smoking.
- Limit the hours of operation. Try to fill each day with jobs where operating the trimmer or other hand-held power equipment is not required.
- If you experience discomfort, redness, and swelling of the fingers followed by whitening and loss of feeling, consult your physician before further exposing yourself to cold and vibration.



Repetitive Stress Injuries

It is believed that overusing the muscles and tendons of the fingers, hands, arms and shoulders may cause soreness, swelling, numbness, weakness, and extreme pain in those areas. Certain repetitive hand activities may put you at a high risk for developing a Repetitive Stress Injury (RSI). An extreme RSI condition is Carpal Tunnel Syndrome (CTS), which could occur when your wrist swells and squeezes a vital nerve that runs through the area. Some believe that prolonged exposure to vibration may contribute to CTS. CTS can cause severe pain for months or even years.

To reduce the risk of RSI/CTS, do the following:

- Avoid using your wrist in a bent, extended, or twisted position. Instead, try to maintain a straight wrist position. Also, when grasping, use your whole hand, not just the thumb and index finger.
- Take periodic breaks to minimize repetition and rest your hands.
- Reduce the speed and force with which you do the repetitive movement.
- Do exercises to strengthen the hand and arm muscles.
- Immediately stop using all power equipment and consult a doctor if you feel tingling, numbness, or pain in the fingers, hands, wrists, or arms. The sooner RSI/CTS is diagnosed, the more likely permanent nerve and muscle damage can be prevented.

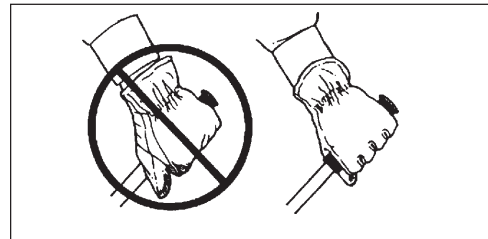

EQUIPMENT

WARNING **DANGER**

Use only ECHO approved attachments. Serious injury may result from the use of a non-approved attachment combination. ECHO, INC. will not be responsible for the failure of cutting devices, attachments or accessories which have not been tested and approved by ECHO. Read and comply with all safety instructions listed in this manual and safety manual.

- Check unit for loose/missing nuts, bolts, and screws. Tighten and/or replace as needed.
- Inspect fuel lines, tank, and area around carburetor for fuel leaks. DO NOT operate unit if leaks are found.
- Inspect shield for damage and ensure that the cut-off knife is securely in place. Replace if either is damaged or missing.
- Check that the cutting attachment is firmly attached and in safe operating condition.
- Check that front loop handle and shoulder strap/ or shoulder/ waist harness are adjusted for safe, comfortable operation. See Assembly Section for proper adjustment.

SAFE OPERATION

WARNING DANGER

Do not operate this product indoors or in inadequately ventilated areas. Engine exhaust contains poisonous emissions and can cause serious injury or death.

Read the Manuals

- Provide all users of this equipment with the Operator's Manual and Safety Manual for instructions on Safe Operation.

Clear the Work Area

- Spectators and fellow workers must be warned, and children and animals prevented from coming nearer than 15 m (50 ft.) while the unit is in use.

Keep a Firm Grip

- Hold the front and rear handles with both hands, with thumbs and fingers encircling the handles.

Keep a Solid Stance

- Maintain footing and balance at all times. Do not stand on slippery, uneven or unstable surfaces. Do not work in odd positions or on ladders. Do not over reach.

Avoid Hot Surfaces

- Keep exhaust area clear of flammable debris. Avoid contact during and immediately after operation.

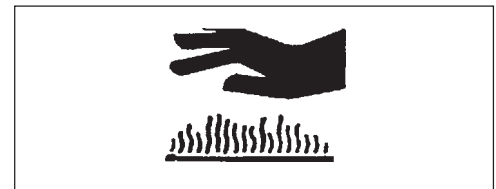

EMISSION CONTROL

EPA Phase 2

The emission control systems for these engines are EM (Engine Modification).

An Emission Control Label is located on the engine. (This is an EXAMPLE ONLY, information on label varies by engine FAMILY).

IMPORTANT ENGINE INFORMATION

ENGINE FAMILY: 4EHXS.0234EA DISPLACEMENT: 22.8 cc
EMISSION COMPLIANCE PERIOD: 300 HRS.
THIS ENGINE MEETS U.S. EPA PHASE 2 EMISSION
REGULATIONS FOR SMALL NONROAD ENGINES. REFER
TO OWNER'S MANUAL FOR MAINTENANCE SPECIFICA-
TIONS AND ADJUSTMENTS.



KIORTZ CORP. 

PRODUCT EMISSION DURABILITY

The 300 hour emission durability compliance period is the time span selected by the manufacturer certifying the engine emissions output meets applicable emissions regulations, provided that approved maintenance procedures are followed as listed in the Maintenance Section of this manual.

DESCRIPTION

The ECHO product you purchased has been partially assembled for your convenience. Due to packaging restrictions, installation of the plastic debris shield, nylon line head, and positioning of the front handle are necessary.



After opening the carton, check for damage. Immediately notify your retailer or ECHO Dealer of damaged or missing parts. Use the contents list to check for missing parts.

* Some Echo units may be factory pre-assembled. The nylon line head, plastic debris shield, and mounting hardware shown in the contents list are pre-assembled to the unit. No assembly tools are needed. The front handle may need to be re-positioned for comfortable operation.

CONTENTS

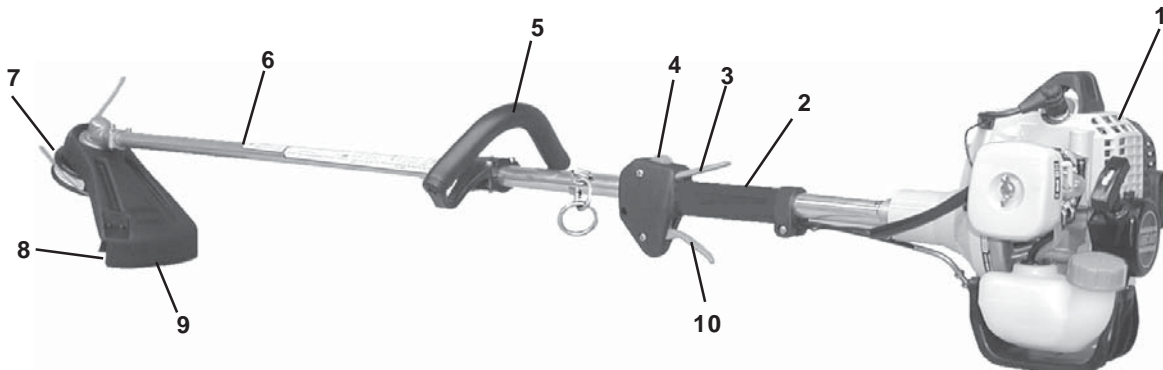
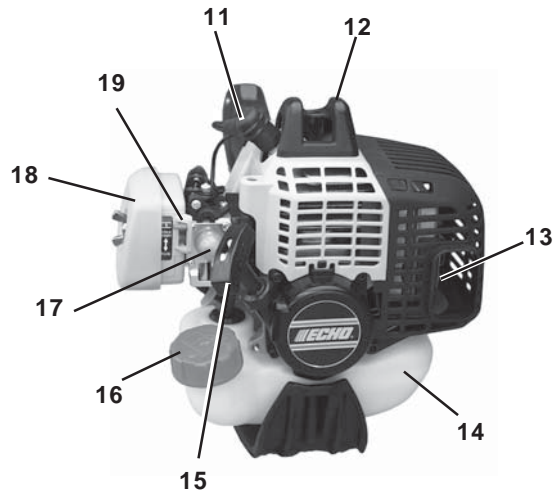
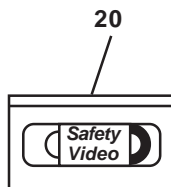
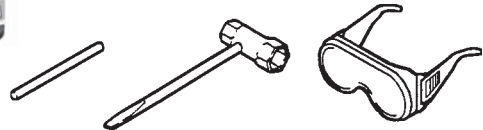
- _____ 1 - Power Head / Drive Shaft Assembly
- _____ 1 - Operator's Manual
- _____ 1 - Safety Manual
- _____ 1 - Warranty Registration Card
- _____ 1 - Limited Warranty Statement
- _____ 1 - Safety Glasses
- _____ 1 - Echo Power Blend™ 2-stroke oil sample
- * ____ 1 - Nylon Trimmer Head
- * ____ 1 - T-wrench 17x19, P/N 89541008030
- * ____ 1 - Locking tool, P/N 89751801131
- * ____ 1 - Plastic shield
- * ____ 1 - Shield plate
- * ____ 3 - 5mm x 16mm screws (shield mtg.)



1. **POWER HEAD** - Includes the Engine, Clutch, Fuel System, Ignition System and Recoil Starter.
2. **GRIP** - Rear (right hand) handle.
3. **THROTTLE TRIGGER LOCKOUT** - This lever must be held during starting. Operation of the throttle trigger is prevented unless throttle trigger lockout lever is engaged.
4. **STOP SWITCH** - "SLIDE SWITCH" mounted on top of the Throttle Trigger Housing. Move switch FORWARD to RUN, BACK to STOP.
5. **FRONT HANDLE** - The Front (loop) handle is loosely assembled to the Drive Shaft assembly and must be positioned for proper cutting attitude and operator comfort.
6. **DRIVE SHAFT ASSEMBLY** - Includes the Rear (right hand) Handle assembly, Gear Housing assembly, Front (loop, left hand) Handle assembly, steel drive shaft and Safety Decal.
7. **NYLON CUTTER HEAD** - Contains replaceable nylon trimming line that advances when the trimmer head is tapped against the ground while the head is turning at normal operating speed.
8. **CUT-OFF KNIFE** - Automatically trims line to the correct length: 5" after head is tapped on the ground. If trimmer is operated without a cut-off knife the line will become too long, the engine will overheat and engine damage may occur.
9. **PLASTIC DEBRIS SHIELD ASSEMBLY** - Included in plastic bag (co-pack). **MUST** be installed on unit before use, see Assembly Instructions. Shield assembly includes the Cut-Off Knife. Mounts on the Gear Housing Assembly just above the cutting attachment. Helps protect the operator by deflecting debris produced during the trimming operation. This shield must be replaced with the steel shield for blade use.
10. **THROTTLE TRIGGER** - Spring loaded to return to idle when released. During acceleration, press trigger gradually for best operating technique.
11. **SPARK PLUG** - Provides spark to ignite fuel mixture.
12. **TOP GUARD** - Protects arm from the hot engine.
13. **SPARK ARRESTOR - CATALYTIC MUFFLER/MUFFLER** - The muffler or catalytic muffler controls exhaust noise and emission. The spark arrestor screen prevents hot, glowing particles of carbon from leaving the muffler. Keep exhaust area clear of flammable debris.
14. **FUEL TANK** - Contains fuel and fuel filter.
15. **RECOIL STARTER HANDLE** - Pull handle slowly until starter engages, then quickly and firmly. When engine starts, return handle slowly. DO NOT let handle snap back or damage to unit will occur.
16. **FUEL TANK CAP** - Covers and seals fuel tank opening.
17. **PRIMER BULB** - Pumping primer bulb before starting engine draws fresh fuel from the fuel tank priming the carburetor for starting. Pump primer bulb until fuel is visible and flows freely in the clear fuel tank return line. Pump bulb an additional 4 or 5 times.
18. **AIR CLEANER** - Contains replaceable filter element.
19. **CHOKE** - The choke control is located on the top of the air filter case. Move choke lever to "Cold Start" () to close choke for cold start. Move choke lever to "Run" () position to open choke.
20. **SAFETY VIDEO** - (Not included with unit) P/N 99922202540 English version and P/N 99922203508 Spanish version are available at a cost of \$5.00 from ECHO, INC. or any authorized ECHO dealer. The video overviews safety precautions and proper operating techniques and is supplemental to the Safety Manual. Read and understand the Safety Manual for complete information on safe operation.

SPECIFICATIONS

MODELS	SRM-230, SRM-230S
Length	1795 mm (70.7 in.)
Width	250 mm (9.84 in.)
Height	250 mm (9.84 in.)
Weight (dry) w/Cutter Head (SRM-230)	5.1 kg (11.2 lb.)
Weight (dry) w/Cutter Head (SRM-230S)	4.9 kg (10.8 lb.)
Engine Type	Air cooled, two-stroke, single cylinder gasoline engine
Bore	32.2 mm (1.27 in.)
Stroke	28.0 mm (1.10 in.)
Displacement	22.8 cc (1.39 cu. in.)
Exhaust	Spark Arrestor Muffler
Carburetor	Zama w/purge pump
Ignition System	Flywheel magneto, transistor control ignition type
Spark Plug	NGK BPM-8Y (Gap 0.65 mm (0.026 in.))
Fuel	Mixed (Gasoline and Two-stroke Oil)
Fuel/Oil Ratio	50:1 two-stroke air cooled engine oil
Gasoline	89 Octane unleaded. DO NOT use fuel containing methyl alcohol, more than 10% ethyl alcohol or 15% MTBE.
Oil	Power Blend™ Premium Universal 2-Stroke Oil
Fuel Tank Capacity	0.58 lit. (19.6 US fl. oz.)
Starter System	Automatic Rewind Starter
Clutch	Centrifugal Type
Vibration Isolated System	Rubber cushion on engine mount (heavy duty). Rubber grip on front handle.
Operating Rod	25.0 mm aluminum tube
Drive Shaft (SRM-230)	6.35 mm (1/4 in.) flexible shaft
Drive Shaft (SRM-230S)	7 mm (1/4 in.) steel shaft
Gear Case Ratio	1.4:1 Reduction
Rotating Direction	Counter Clockwise; viewed from top
Cutter Head	Nylon line head (2-line) with .095 Crossfire™ Line capacity 6 m (20 ft.)
Handle	Front - Loop and right rear handle with rubber grip
Shoulder Harness	Optional
Idle Speed	2,400 - 3,200 RPM
Wide Open Throttle Speed (W.O.T.) with Nylon Line Head	8,500 - 10,500 RPM
Wide Open Throttle Speed (W.O.T.) with Blade	9,500 - 11,500 RPM

ASSEMBLY

Tools Required: Screwdriver, Head Locking Tool

Parts Required: Plastic Shield, Shield Plate, three (3) 5mm x 16mm screws, Nylon Line Head, Front Handle Assembly

PLASTIC SHIELD INSTALLATION

(For Nylon Line Operation)

NOTE

The plastic shield is for use with the Nylon Line Head only.
Install Metal Shield when using plastic or metal blades.

1. Remove plastic sleeve and upper plate (A) from PTO shaft.
2. Install the shield on the bottom of the bearing housing flange.
3. Place shield plate (B) on shield, align holes and install three (3) 5x16mm screws.
4. Install upper plate (A).

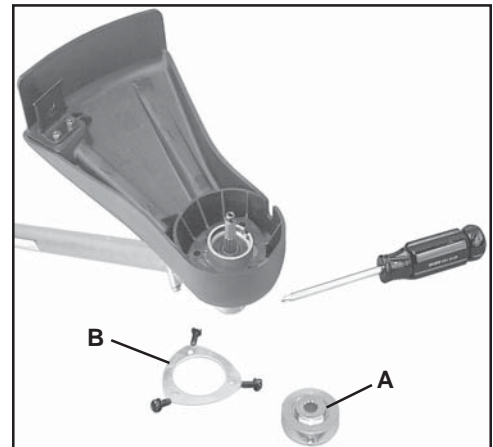

NYLON LINE HEAD INSTALLATION

(Use with Plastic Shield)

1. Be sure upper adaptor plate remains on PTO shaft.
2. Align locking hole in upper plate with notch in edge of gear housing and insert head locking tool (C).
3. Thread line head onto shaft by turning it counter clockwise until head is tight against upper plate.
4. Remove head locking tool.

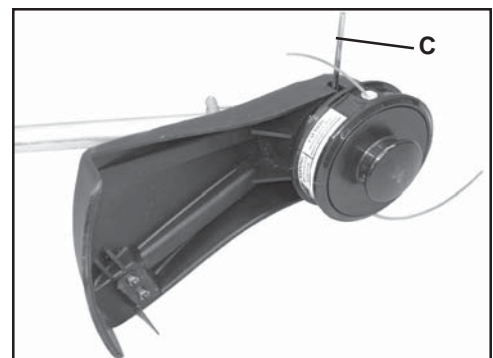

FRONT HANDLE INSTALLATION

1. Position front handle for comfortable operation and secure screws.

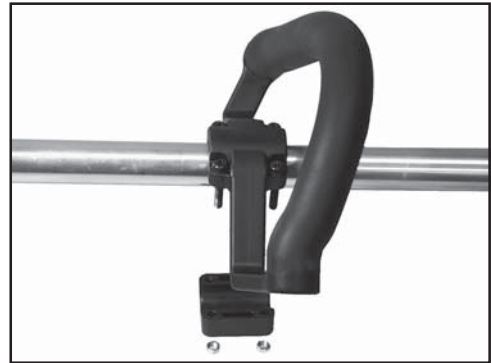

PRE - OPERATION OPERATION WITH BLADES

Preparing the Trimmer/Brush Cutter for Blade Use

WARNING DANGER

Blade use **DEMANDS** specific Brush Cutter configuration. Operation without specified shield, handle, and harness can result in serious personal injury. Follow installation instructions included in optional kits.

Grass/Weed Blades Require:

Install Blade Conversion Kit, P/N 99944200415 - Includes metal shield (A), barrier bar (B), and shoulder harness (C).

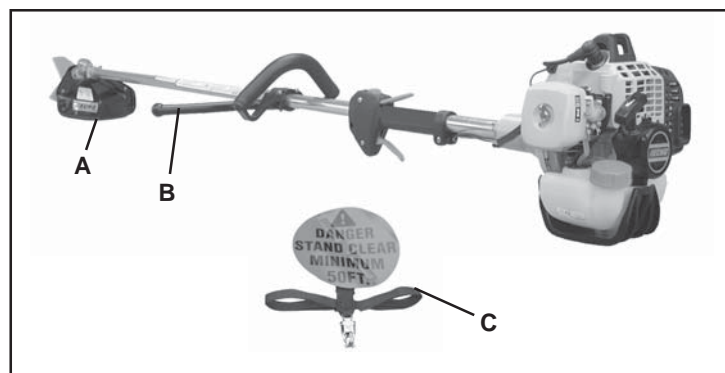

NOTE

The Barrier Bar is used to restrict rearward movement of the unit. The Barrier Bar is NOT A HANDLE and should not be gripped when using or carrying the unit.

Brush/Clearing Blades Require:

Install U-Handle / Blade Conversion Kit, P/N 99944200521 - Includes metal shield (A), shoulder harness with hip pad (C), and U-Handles (D).

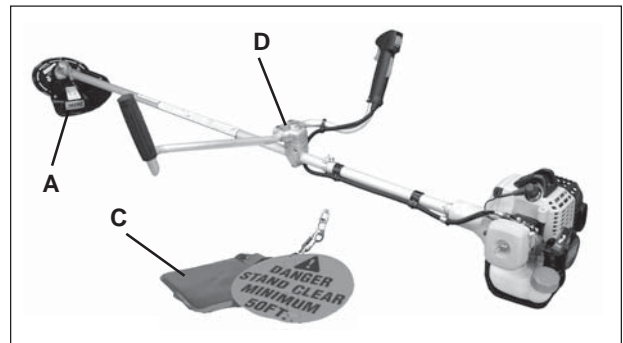

Choosing the Correct Blade

WARNING



DANGER

The type of Blade used **MUST** be matched to the type and size of material cut. An improper or dull blade can cause serious personal injury. Blades **MUST** be sharp. Dull blades increase the chance of kick-out and injury to yourself and bystanders.

Plastic/Nylon Blades may be used where ever the nylon line head is used. **DO NOT** use this blade for heavy weeds or brush!



8 Tooth Weed/Grass Blade (P/N 69600120331) is designed for grass, garden debris and thick weeds. **DO NOT** use this blade for brush or heavy woody growth, 19 mm (3/4 in.) diameter or larger.

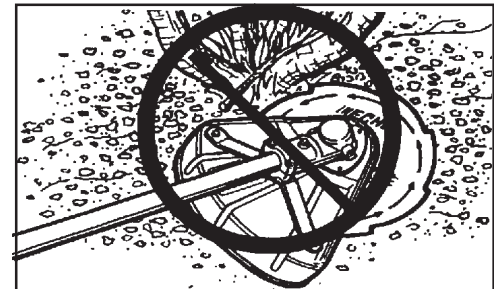

80 Tooth Brush Blade (P/N 69500120331) is designed for cutting brush and woody growth up to 64 mm (2-1/2 in.) diameter.

22 Tooth Clearing Blade (99944200130) is designed for dense thickets and saplings up to 64 mm (2-1/2 in.) diameter.



Use Shoulder/Waist Harness (P/N 99944200200) Use of the Shoulder/Waist Harness is recommended for **ALL** Trimmer/Brush Cutter use. The Shoulder/Waist Harness suspends the trimmer from the operator's shoulder and reduces operator fatigue.

The restrictive harness enhances operator safety by reducing the possibility of blade contact with the operator's hands and feet.



FUEL

Fuel Requirements

Gasoline - Use 89 Octane [R+M/2] (mid grade or higher) gasoline or gasohol known to be good quality. Gasohol may contain up to 10% Ethyl (grain) alcohol or 15% MTBE (methyl tertiary-butyl ether). Gasohol containing methyl (wood) alcohol is **NOT** approved.

Two Stroke Oil - A two-stroke engine oil meeting ISO-L-EGD (ISO/CD 13738) and J.A.S.O. FC Standards must be used. Echo brand premium Power Blend™ Universal 2-Stroke Oil meets these standards. Engine problems due to inadequate lubrication caused by failure to use an ISO-L-EGD and J.A.S.O. FC certified oil, such as Echo premium Power Blend™, will void the two-stroke engine warranty. (Emission related parts only are covered for two years, regardless of two-stroke oil used, per the statement listed in the Emission Defect Warranty Explanation.)

IMPORTANT

Echo premium Power Blend™ Universal 2-Stroke Oil may be mixed at 50:1 ratio for application in all Echo engines sold in the past regardless of ratio specified in those manuals.

Mixing Instructions

1. Fill an approved fuel container with half of the required amount of gasoline.
2. Add the proper amount of 2-stroke oil to gasoline.
3. Close container and shake to mix oil with gasoline.
4. Add remaining gasoline and remix.
5. Install fuel container cap and wipe any spilled fuel from container and surrounding area.

Handling Fuel

WARNING DANGER

Fuel is **VERY** flammable. Use extreme care when mixing, storing or handling, or serious personal injury may result.

- Use an approved fuel container.
- **DO NOT** smoke near fuel.
- **DO NOT** allow flames or sparks near fuel.
- Fuel tanks/cans may be under pressure. Always loosen fuel caps slowly allowing pressure to equalize.
- **NEVER** refuel a unit when the engine is **HOT!**
- **NEVER** refuel a unit with the engine running.
- **DO NOT** fill fuel tanks indoors. **ALWAYS** fill fuel tanks outdoors over bare ground.
- Securely tighten fuel cap after refueling.
- Inspect for fuel leakage. If fuel leakage is found, do not start or operate unit until leakage is repaired.

Fuel to Oil Mix - 50:1 Ratio

U.S.		METRIC	
GAS	OIL	GAS	OIL
Gallons	Fl. oz.	Liter	cc.
1	2.6	4	80
2	5.2	8	160
5	13	20	400

IMPORTANT

Spilled fuel is a leading cause of hydrocarbon emissions. Some states may require the use of automatic fuel shut-off containers to reduce fuel spillage. Contact your ECHO dealer for ordering information.

After refueling

- Wipe any spilled fuel from the unit.
- Move at least 3 m (10 ft.) from refueling location before starting the engine.

After use

- **DO NOT** store a unit with fuel in its tank. Leaks can occur. Return unused fuel to an approved fuel storage container.

Storage

Fuel storage laws vary by locality. Contact your local government for the laws affecting your area. As a precaution, store fuel in an approved, air tight container. Store in a well ventilated, unoccupied building, away from sparks and flames. Do not store fuel longer than 30 days.

IMPORTANT

Stored fuel ages. Do not mix more fuel than you expect to use in thirty (30) days, ninety (90) days when a fuel stabilizer is added.

IMPORTANT



Stored two-stroke fuel may separate. **ALWAYS** shake fuel container thoroughly before each use.

OPERATION

STARTING COLD ENGINE

WARNING DANGER

The attachment will operate immediately when the engine starts and could result in loss of control and possible serious injury. Keep movable parts of the attachment off the ground and away from objects that could become entangled or thrown.

- 1. Stop Switch**
Move stop switch button (A) forward away from the STOP position.
- 2. Choke**
Move choke lever (B) to Cold Start Position (.
- 3. Primer**
Pump primer bulb (C) until fuel is visible and flows freely in the clear fuel tank return line. Pump bulb an additional 4 or 5 times.
- 4. Recoil Starter**
Lay the unit on a flat area and keep movable attachment parts clear of all obstacles. Firmly grasp right hand grip and throttle trigger lockout with left hand and fully depress throttle trigger to wide open position. Rapidly pull recoil starter handle/rope (D) until engine fires (or maximum five [5] pulls).
- 5. Choke**
After engine fires (or 5 pulls), move choke lever back to Run ( position. Hold throttle trigger and throttle trigger lockout fully depressed, and pull recoil starter starter handle/rope until engine starts and runs. Release throttle trigger, and allow unit to warm up at idle for several minutes.

NOTE

If engine does not start with choke in "Run" position after 5 pulls, repeat instructions 4 and 5.

- 6. Throttle Trigger**
After engine warm-up, gradually depress throttle trigger to increase engine RPM to operating speed.

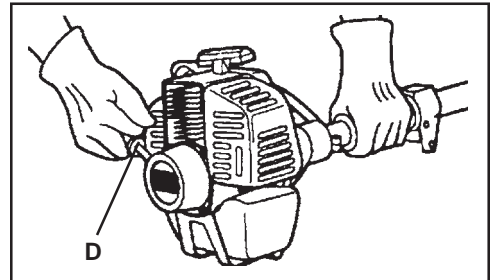
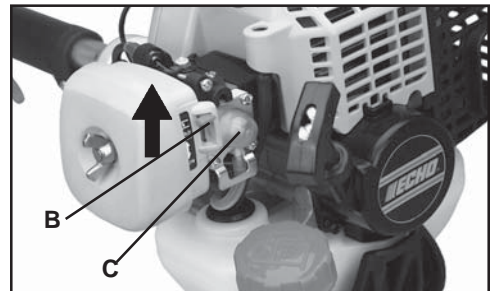
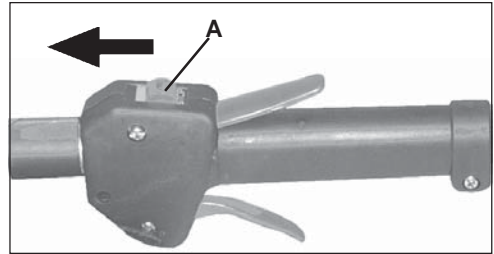

STARTING WARM ENGINE

The starting procedure is the same as Cold Start except DO NOT close the choke, and do not depress throttle trigger to wide open position.

WARNING DANGER

The attachment should not move at idle, otherwise serious personal injury may result.

NOTE

If attachment moves, readjust carburetor according to "Carburetor Adjustment" instructions in this manual or see your ECHO Dealer.

1. *Stop Switch*
Move stop switch button (A) away from the STOP position.
2. *Primer*
Pump primer bulb (C) until fuel is visible and flows freely in the clear fuel tank return line. Pump bulb an additional 4 or 5 times.
3. *Recoil Starter*
Lay the unit on a flat area and keep movable attachment parts clear of all obstacles. Rapidly pull recoil starter handle/rope (D) until engine fires.

NOTE

If engine does not start after 5 pulls, use Cold Start Procedure.

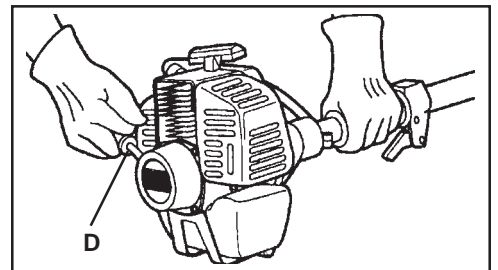
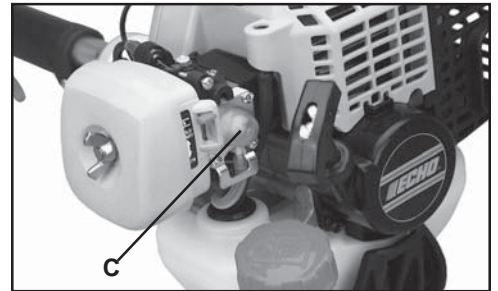
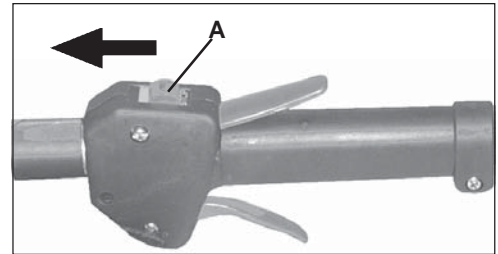

STOPPING ENGINE

1. *Throttle*
Release throttle and allow engine to return to idle before shutting off engine.
2. *Stop Switch*
Move stop switch button (A) backward to STOP position.

WARNING DANGER

If engine does not stop when stop switch is moved to STOP position, close choke - COLD START position - to stall engine. Have your ECHO dealer repair stop switch before using trimmer again.

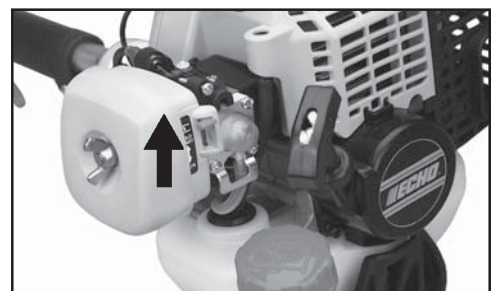
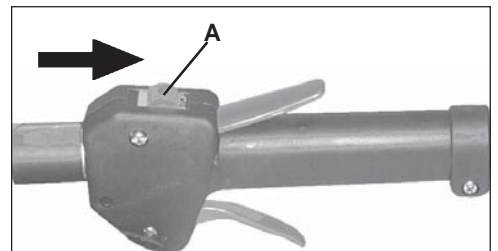

MAINTENANCE

Your ECHO trimmer is designed to provide many hours of trouble free service. Regular scheduled maintenance will help your trimmer achieve that goal. If you are unsure or are not equipped with the necessary tools, you may want to take your unit to an ECHO Service Dealer for maintenance. To help you decide whether you want to DO-IT-YOURSELF or have the ECHO Dealer do it, each maintenance task has been graded. If the task is not listed, see your ECHO Dealer for repairs.

SKILL LEVELS

- Level 1**= Easy to do. Most required tools come with unit.
- Level 2**= Moderate difficulty. Some specialized tools may be required.
- Level 3**= Experience required. Specialized tools are required. ECHO recommends that the unit be returned to your ECHO dealer for servicing.

ECHO offers **REPOWER™** Maintenance Kits and Parts to make your maintenance job easier. Below each task heading are listed the various part numbers required for that task. See your ECHO dealer for these parts.

MAINTENANCE INTERVALS

COMPONENT/ SYSTEM	MAINTENANCE PROCEDURE	REQ'D SKILL LEVEL	DAILY OR BEFORE USE	EVERY REFUEL	3 MONTHS OR 90 HOURS	6 MONTHS OR 270 HOURS	YEARLY 600 HOURS
Recommended Echo Dealer Maintenance Procedures							
Cylinder Exhaust Port	Inspect/Clean/Decarbon	3			I / C		
Do-It-Yourself Maintenance Procedures							
Air Filter	Inspect/Clean/Replace	1	I / C		R*		
Choke	Inspect/Clean	2	I / C				
Fuel Filter	Inspect/Replace	1			I		I / R *
Fuel System, leaks	Inspect/Replace	1	I *	I	I		
Cooling System	Inspect/Clean	2	I / C				
Muffler Spark Arrestor	Inspect/Replace	2			I / R *		
Drive Shaft (Flex Cable Models)	Grease	2			I (1)		
Gear Housing	Grease	2			I (2)		
Recoil Starter Rope	Inspect/Clean	1	I / C *				
Spark Plug	Inspect/Clean	2			I / C	R *	
Screws/Nuts/Bolts	Inspect/Tighten/Replace	1	I / R *				

MAINTENANCE PROCEDURE LETTER CODES: I = INSPECT, R = REPLACE, C = CLEAN

IMPORTANT NOTE - Time intervals shown are maximum. Actual use and your experience will determine the frequency of required maintenance.

MAINTENANCE PROCEDURE NOTES:

(1) Apply ECHO® LUBE™ every 25 hours of use.

(2) Apply ECHO® LUBE™ every 50 hours of use.

* All recommendations to replace are based on the finding of damage or wear during inspection..

AIR FILTER

Level 1.

Tools Required: Cleaning brush 25 or 50 mm (1 or 2 in.)

Parts Required: 90008 REPOWER™ AIR & FUEL FILTER KIT.

1. Close choke (Cold Start Position ). This prevents dirt from entering the carburetor throat when the air filter is removed. Brush accumulated dirt from the air cleaner area.
2. Remove the air cleaner cover. Clean and inspect the element for damage. If element is fuel soaked and very dirty, replace.
3. If element can be cleaned and reused, be certain it:
 - still fits the cavity in the air cleaner cover.
 - is installed with the original side out.

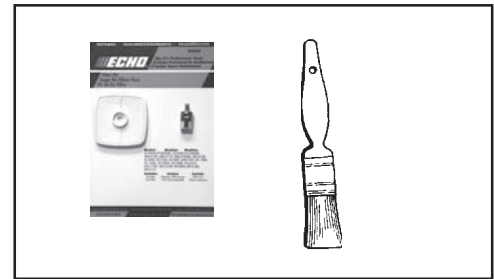

FUEL FILTER

Level 1.

Tools Required: 200-250 mm (8-10 in.) length of wire with one end bent into a hook, clean rag, funnel, and an approved fuel container.

Parts Required: 90008 REPOWER™ AIR & FUEL FILTER KIT.

WARNING  **DANGER**

Fuel is **VERY** flammable. Use extreme care when mixing, storing or handling.

1. Use a clean rag to remove loose dirt from around fuel cap and empty fuel tank.
2. Use the “fuel line hook” to pull the fuel line and filter from the tank.
3. Remove the filter from the line and install the new filter.

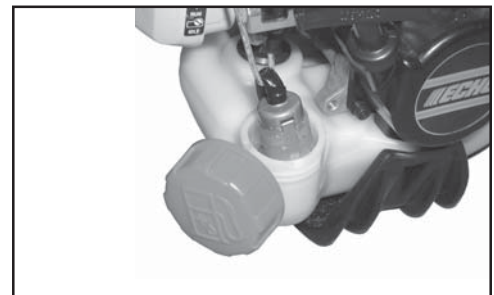

SPARK PLUG

Level 2.

Tools Required: T-Wrench, feeler gauge, soft metal brush.

Parts Required: REPOWER™ Tune-Up Kit P/N90074

1. Remove spark plug and check for fouling, worn and rounded center electrode.
2. Clean the plug or replace with a new one. DO NOT sand blast to clean. Remaining sand will damage engine.
3. Adjust spark plug gap by bending outer electrode.
4. Tighten spark plug to 145-155 kg/cm (125-135 in. lb.).

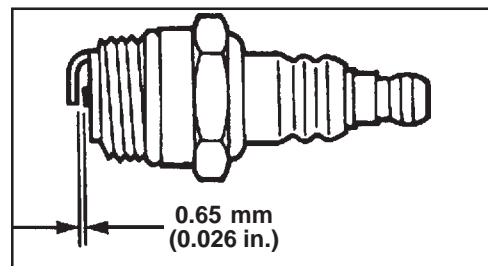
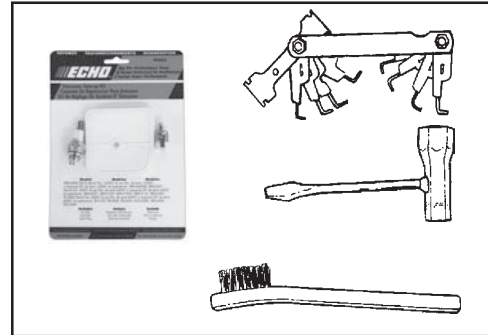

COOLING SYSTEMS CLEANING

Level 2.

Tools Required: 4 mm Hex Wrench, cleaning brush, 25 or 50 mm (1 or 2 in.)

Parts Required: None if you are careful.

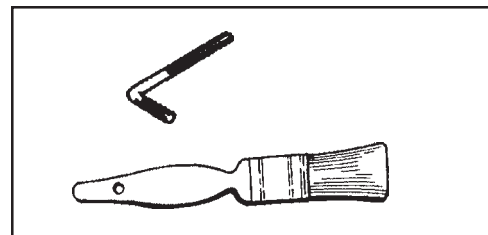

IMPORTANT

To maintain proper engine operating temperatures, cooling air must pass freely through the cylinder fin area. This flow of air carries combustion heat away from the engine.

Overheating and engine seizure can occur when:

- Air intakes are blocked, preventing cooling air from reaching the cylinder.
- Dust and grass build up on the outside of the cylinder. This build up insulates the engine and prevents the heat from leaving.

Removal of cooling passage blockages or cleaning of cooling fins is considered "Normal Maintenance." Any failure attributed to lack of maintenance is not warranted.

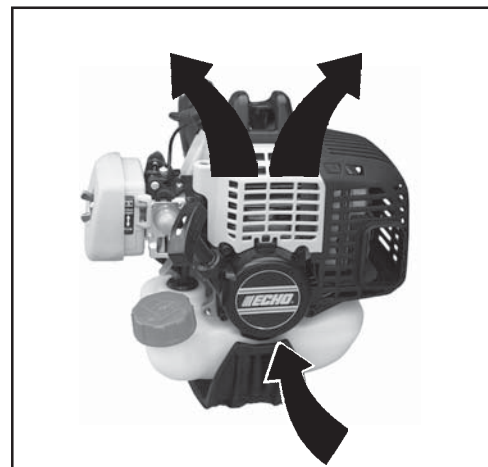

1. Remove spark plug lead.
2. Remove two (2) muffler cover screws and muffler cover (A).
3. Remove screw and top guard (B).
4. Remove engine cover (C).

IMPORTANT

DO NOT use a metal scraper to remove dirt from the cylinder fins.

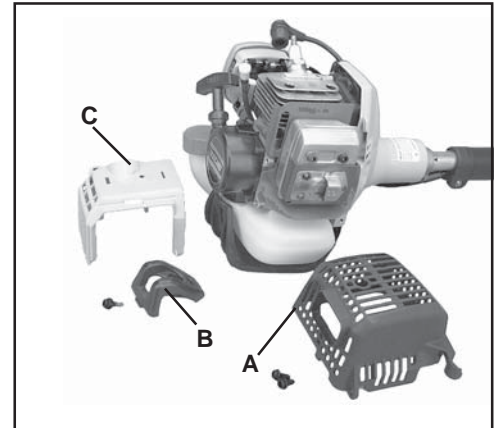

5. Use brush to remove dirt from the cylinder fins.

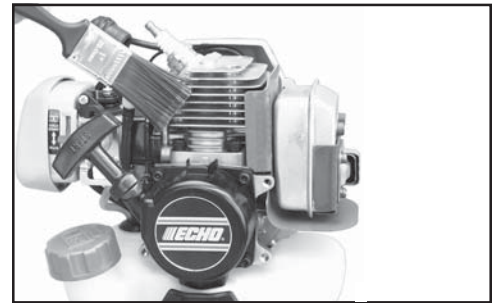

6. Remove grass and leaves from the grid between the recoil starter and fuel tank.
7. Assemble components in reverse order.

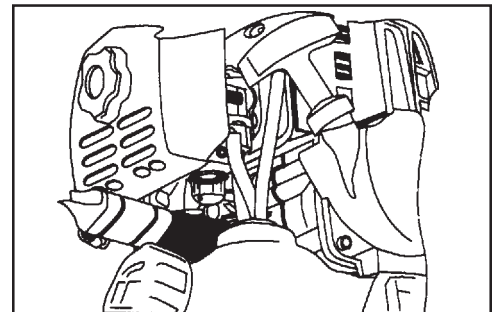

EXHAUST SYSTEM

Spark Arrestor Screen

Level 2.

Tools Required: Cross Head Screwdriver, Soft Metal Brush, 4mm Hex Wrench

Parts Required: Spark Arrestor Screen, Gasket

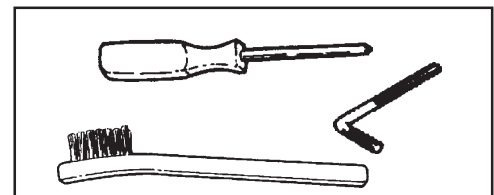

1. Remove spark plug lead.
2. Remove two (2) muffler cover screws and muffler cover (A).
3. Place piston at Top Dead Center (TDC) to prevent carbon/dirt from entering cylinder.
4. Remove spark arrestor screen cover (B), gasket (C) and screen (D) from muffler body.
5. Clean carbon deposits from screen and muffler components.
6. Replace screen if it is cracked, plugged or has holes burned through.
7. Assemble components in reverse order.

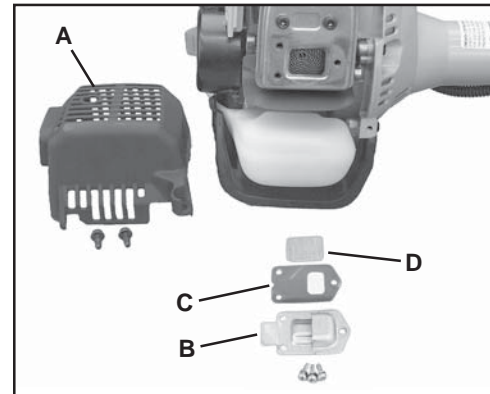

Cylinder Exhaust Port

Level 3

IMPORTANT

The cylinder exhaust port must be inspected and cleaned of excess carbon every 3 months or 90 hours of operation in order to maintain this engine within the emissions durability period. ECHO strongly recommends that you return your unit to your ECHO dealer for this important maintenance service.

CARBURETOR ADJUSTMENT

Engine Break-In

New engines must be operated a minimum duration of two tanks of fuel break-in before carburetor adjustments can be made. During the break-in period your engine performance will increase and exhaust emissions will stabilize. Idle speed can be adjusted as required.

High Altitude Adjustment

High altitude adjustment is not required for proper operation of this engine.

Level 2.

Tools Required: Screwdriver, Tachometer (ECHO P/N 99051130017).

Parts Required: None.

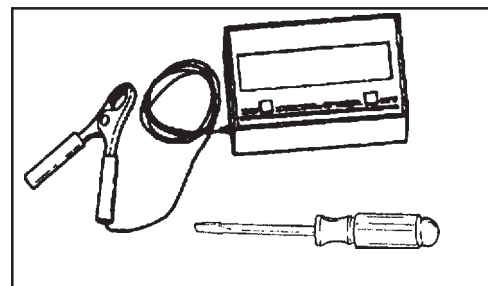

NOTE

Every unit is run at the factory and the carburetor is set in compliance with Emission Regulations. This carburetor does not have acceleration and high speed adjustment needles.

1. Check idle speed and reset if necessary. If a tachometer is available, idle speed screw (A) should be set to the specifications found on page 10 "Specifications" of this manual. Turn idle screw (A) clockwise to increase idle speed; counter clockwise to decrease idle speed.

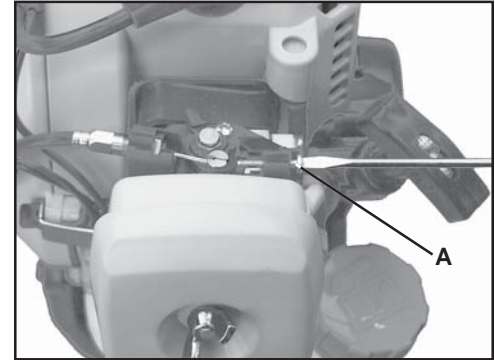

WARNING  **DANGER**

When carburetor adjustment is completed, the cutting attachment should not move at idle, otherwise serious personal injury may result.

LUBRICATION

Level 1.

Tools Required: 8 mm Open End Wrench, Screwdriver, Clean Rag.

Parts Required: ECHO[®] LUBE™ 8 oz. (P/N 91014) or Lithium Base Grease.

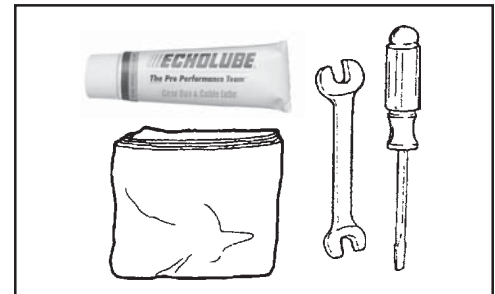

Gear Housing

1. Clean all loose debris from gear box.
2. Remove plug (A) and check level of grease.
3. Add grease if necessary, DO NOT over fill.

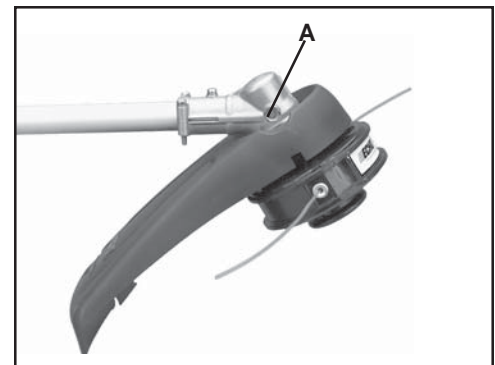

Drive Shaft

1. Loosen two (2) screws (B) and remove center locating screw (C). Pull gear box and shield from drive shaft housing.
2. Pull flexible cable from the drive shaft housing, wipe clean and recoat with a thin coating [15 ml (1/2 oz.)] of ECHO[®] LUBE™ grease.
3. Slide the flexible cable back in the drive housing. DO NOT get dirt on the flex cable.
4. Install the gear housing and shield assembly.

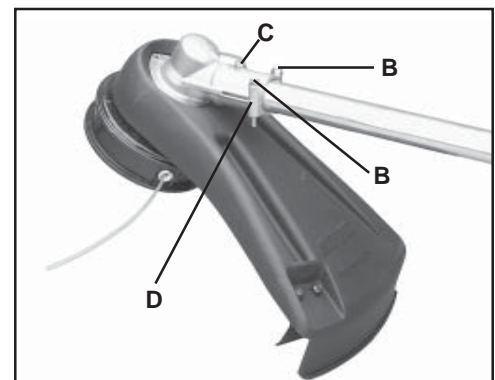

IMPORTANT

Flat edge of washers (D) must be against drive shaft.

NYLON LINE REPLACEMENT

Level 1.

Parts Required: ECHO 2.4mm (0.095 in.) Nylon Trimmer Line 12m (40 feet [two 20 ft. sections])

Echomatic Pro Trimmer Head

1. Do not push spool in. Hold drum and turn spool clockwise until peg clicks and disappears from hole. Pull spool out of drum.
2. Place ends of two 20 ft. x .095 in. Crossfire™ trimmer lines into holes in spool, one on each side of barrier.
3. Wind both lines tightly and evenly (one on each side of barrier) in the direction of arrow on bottom of spool.
4. Place ends of lines into notches in spool, leaving 6 in. protruding.
5. Feed ends of line outward through eyelets in drum.
6. Turn inner drive so that pegs in drive align with grooves in spool, and push spool into drum.
7. Hold spool and drum securely with one hand, and pull each line to disengage from notches.
8. Hold drum and twist spool counter clockwise until peg clicks into hole.
9. Trim lines to 8 in. length.

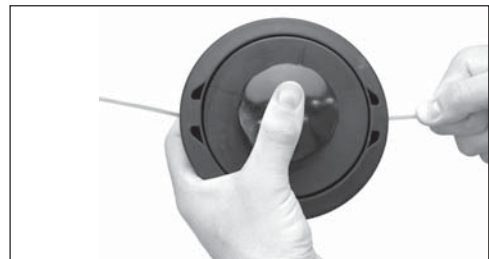
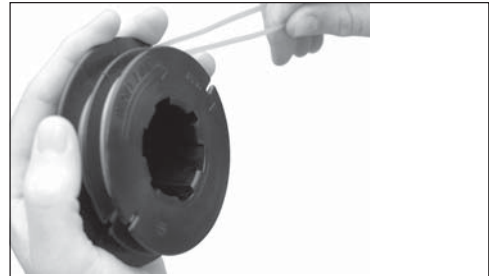

SHARPENING METAL BLADES

Three styles of metal blades are approved for use on the ECHO Brush Cutter. The 8-tooth blade can be sharpened during normal maintenance. The clearing blade and 80 tooth blade require professional service.

Before sharpening, CLOSELY inspect blade for cracks (look at the bottom of each tooth and the center mounting hole closely), missing teeth and bending. If ANY of these problems are discovered, replace the blade.

When sharpening a blade, always remove the same amount of materials from each tooth to maintain balance. A blade that is not balanced will cause unsafe handling due to vibration and can result in blade failure.

Tool Required: Flat file (preferred). Electric grinder if special care is used. Round (rat tail) file for gullet (radius).

1. File each tooth at a 30 degree angle a specific number of times, eg. 4 strokes per tooth. Work your way around the blade until all teeth are sharp.
2. DO NOT file the 'gullet' (radius) of the tooth with the flat file. The radius must remain. A sharp corner will lead to a crack and blade failure.

IMPORTANT

If an electric grinder is used, use care not to overheat teeth, do not allow tips/tooth to glow red or turn blue. DO NOT place blade in cooling water. This will change the temper of the blade and could result in blade failure.

3. After sharpening teeth, check each tooth radius for evidence of a square (sharp) corner. Use the round (rat tail) file to renew the radius.

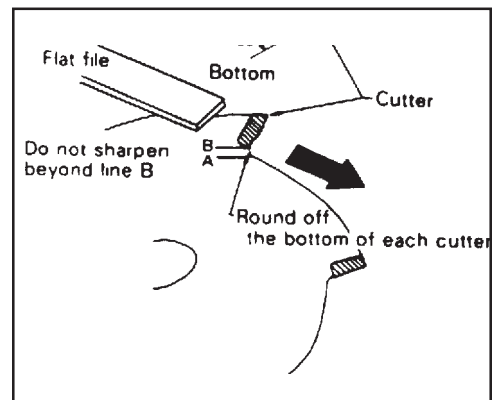
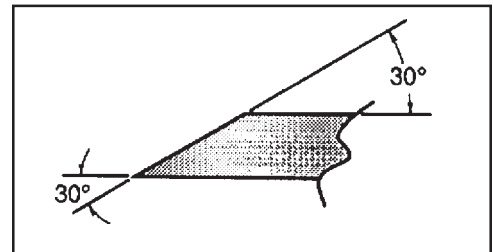
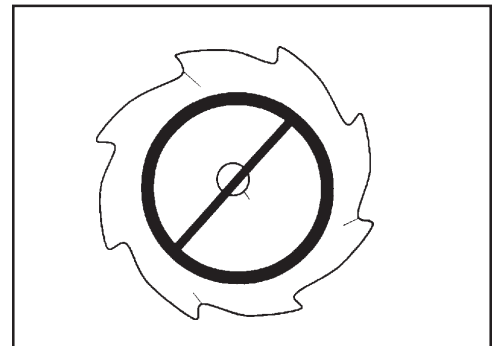

TROUBLESHOOTING

ENGINE PROBLEM TROUBLESHOOTING CHART

Problem	Check	Status	Cause	Remedy
Engine cranks - starts hard/ doesn't start	Fuel at carburetor	No fuel at carburetor	Fuel strainer clogged Fuel line clogged Carburetor	Clean or replace Clean or replace See your Echo dealer
	Fuel at cylinder	No fuel at cylinder	Carburetor	See your Echo dealer
		Muffler wet with fuel	Fuel Mixture too rich	Open choke Clean/replace air filter Adjust carburetor See your Echo dealer
	Spark at end of plug wire	No spark	Stop switch off Electrical problem Interlock switch	Turn switch to ON See your Echo dealer See your Echo dealer
	Spark at plug	No spark	Spark gap incorrect Covered with carbon Fouled with fuel Plug defective	Adjust to .65mm (0.026 in.) Clean or replace Clean or replace Replace plug
Engine runs, but dies or does not accelerate properly	Air filter	Air filter dirty	Normal wear	Clean or replace
	Fuel filter	Fuel filter dirty	Contaminants/residues in fuel	Replace
	Fuel vent	Fuel vent plugged	Contaminants/residues in fuel	Clean or replace
	Spark Plug	Plug dirty/worn	Normal wear	Clean and adjust or replace
	Carburetor	Improper adjustment	Vibration	Adjust
	Cooling System	Excessive dirt/debris	Extended operation in dirty/dusty locations	Clean
	Spark Arrestor Screen	Screen cracked, plugged, or perforated	Normal wear	Replace
Engine does not crank	N/A	N/A	Internal engine problem	See your Echo dealer

WARNING  **DANGER**

Fuel vapors are **extremely** flammable and may cause fire and/or explosion. **Never** test for ignition spark near an open spark plug opening, otherwise serious personal injury may result.

STORAGE

WARNING  **DANGER**

During operation the muffler or catalytic muffler and surrounding cover become hot. Always keep exhaust area clear of flammable debris during transportation or when storing, otherwise serious property damage or personal injury may result.

Long Term Storage (over 30 days)

Do not store your unit for a prolonged period of time (30 days or longer) without performing protective storage maintenance which includes the following:

1. Store unit in a dry, dust free place, out of the reach of children.

WARNING  **DANGER**

Do not store in enclosure where fuel fumes may accumulate or reach an open flame or spark.

2. Place the stop switch (A) in the "STOP" position.
3. Remove accumulation of grease, oil, dirt and debris from exterior of unit.
4. Perform all periodic lubrication and services that are required.
5. Tighten all the screws and nuts.
6. **Drain** the fuel tank **completely** and pull the recoil starter handle several times to remove fuel from the carburetor.
7. Remove the spark plug and pour 7 cc (1/4 oz.) of fresh, clean, two-stroke engine oil into the cylinder through the spark plug hole.
 - A. Place a clean cloth over the spark plug hole.
 - B. Pull the recoil starter handle 2-3 times to distribute the oil inside the engine.
 - C. Observe the piston location through the spark plug hole. Pull the recoil handle slowly until the piston reaches the top of its travel and leave it there.
8. Install the spark plug (do not connect ignition cable).

SERVICING INFORMATION

PARTS

Genuine ECHO Parts and ECHO REPOWER™ Parts and Assemblies for your ECHO products are available only from an Authorized ECHO Dealer. When you do need to buy parts **always** have the Model Number and Serial Number of the unit with you. You can find these numbers on the engine housing. For future reference, write them in the space provided below.

Model No. _____ SN. _____

SERVICE

Service of this product during the warranty period must be performed by an Authorized ECHO Service Dealer. For the name and address of the Authorized ECHO Service Dealer nearest you, ask your retailer or call: 1-800-432-ECHO (3246). Dealer information is also available on our Web Site. When presenting your unit for Warranty service/repairs, proof of purchase is required.

ECHO CONSUMER PRODUCT SUPPORT

If you require assistance or have questions concerning the application, operation or maintenance of this product you may call the ECHO Consumer Product Support Department at 1-800-673-1558 from 8:30 am to 4:30 pm (Central Standard Time) Monday through Friday. Before calling, please know the model and serial number of your unit to help your Consumer Product Support Representative.

WARRANTY REGISTRATION

You may register your Echo equipment using the warranty registration card or register on-line at www.echo-usa.com. Registering provides a direct link between you and ECHO if we find it necessary to contact you.

ADDITIONAL OR REPLACEMENT MANUALS

Safety Manuals in English/Spanish or English/French are available, free of charge, from your ECHO dealer or at www.echo-usa.com.

Operator's and Parts Manuals are available by:

- Downloading free from www.echo-usa.com
- Purchasing from your Echo Dealer.
- Manuals are available by sending a written request stating the model number and serial number of your Echo unit, part number of the manual, your name and address, and mail to the address below.

Safety Videos are available from your Echo dealer. A \$5.00 shipping charge will be required for each video.

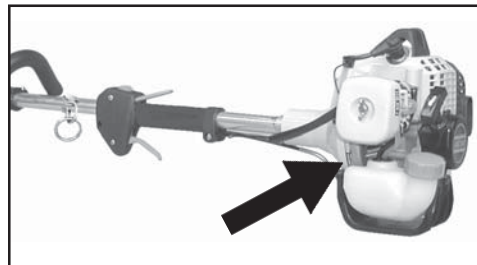

DEALER?

Call
1-800-432-ECHO
or
www.echo-usa.com

CONSUMER PRODUCT SUPPORT

1-800-673-1558
8:30 - 4:30 Mon - Fri C.S.T.



ECHO
ECHO, INCORPORATED

400 OAKWOOD ROAD
LAKE ZURICH, IL 60047
www.echo-usa.com

05143224/05014430