

**ECHO®**

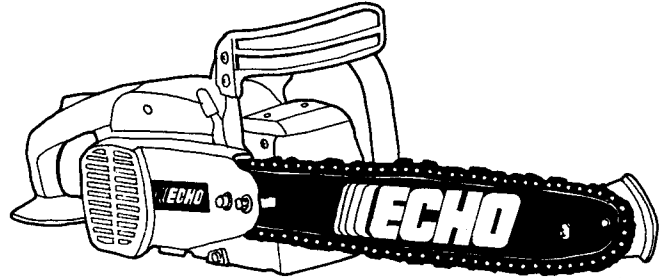

# **OPERATOR'S MANUAL**

## **ECHO CHAIN SAW CS-300EVL**

### **CAUTION**

Read Rules for Safe Operation  
and Instructions Carefully



898 610-3553 0

# RULES FOR SAFE OPERATION

## A. Kickback Safety Precaution for Chain Saw Users

### **WARNING!**

KICKBACK may occur when the nose or tip of the guide bar touches an object, or when the wood closes in and pinches the saw chain in the cut.

Tip contact in some cases may cause a lightning fast reverse REACTION, Kicking the guide bar up and back towards the operator. pinching the saw chain along the top of the guide bar may push the guide bar rapidly back towards the operator. Either of these reactions may cause you to lose control of the saw which could result in serious personal injury.

Do not rely exclusively upon the safety devices built into your saw. As a chain saw user, you should take several steps to keep your cutting jobs free from accident or injury.

1. With a basic understanding of kickback, you can reduce or eliminate the element of surprise. Sudden surprise contributes to accidents.

2. Keep a good firm grip on the saw with both hands, the right hand on the rear handle, and the left hand on the front handle, when the engine is running. Use a firm grip with thumbs and fingers encircling the chain saw handles. A firm grip will help you reduce kickback and maintain control of the saw. Don't let go.
3. Make sure that the area in which you are cutting is free from obstructions. Do not let the nose of the guide bar contact a log, branch, or any other obstruction which could be hit while you are operating the saw.
4. Cut at high engine speeds.
5. Do not overreach or cut above shoulder height.
6. Follow manufacturer's sharpening and maintenance instructions for the saw chain.
7. Only use replacement bars and chains specified by the manufacturer or the equivalent.

## B. Other Safety Precautions

1. Do not operate a chain saw when you are fatigued.
2. Use safety footwear; snug-fitting clothing; protective gloves; and eye, hearing, and head protection devices.
3. Use caution when handling fuel. Move the chain saw at least 10 feet (3 m) from the fueling point before starting the engine.
4. Do not allow other persons to be near the chain saw when starting or cutting with the chain saw. Keep bystanders and animals out of the work area.
5. Do not start cutting until you have a clear work area, secure footing, and a planned retreat path from the falling tree.

6. Keep all parts of your body away from the saw chain when the engine is running.
7. Before you start the engine, make sure that the saw chain is not contacting anything.
8. Carry the chain saw with the engine stopped, the guide bar and saw chain to the rear, and the muffler away from your body.
9. Do not operate a chain saw that is damaged, improperly adjusted, or not completely and securely assembled. Be sure that the saw chain stops moving when the throttle control trigger is released.
10. Shut off the engine before setting the chain saw down.
11. Use extreme caution when cutting small size brush and saplings because slender material may catch the saw chain and be whipped toward you or pull you off balance.
12. When cutting a limb that is under tension, be alert for springback so that you will not be struck when the tension in the wood fibers is released.
13. Keep the handles dry, clean, and free of oil or fuel mixture.
14. Operate the chain saw only in well-ventilated areas.
15. Do not operate a chain saw in a tree unless you have been specifically trained to do so.
16. All chain saw service, other than the items listed in the operator's manual maintenance instructions, should be performed by competent chain saw service personnel. (For example, if improper tools are used to remove the flywheel or if an improper tool is used to hold the flywheel in order to remove the clutch, structural damage to the flywheel could occur and could subsequently cause the flywheel to burst.)
17. When transporting your chain saw, use the appropriate guide bar scabbard.
18. Spark arrester mufflers approved to SAE Standard J335b are Standard on ECHO Chain saws to reduce the possibility of forest fires. Do not operate the chain saw with a loose or defective muffler. Do not remove the spark arrester screen.

## CONTENTS

	Page
RULES FOR SAFE OPERATION .....	1
TECHNICAL DATA .....	4
NOMENCLATURE OF PARTS .....	4
PREPARATION FOR USE .....	5
– GUIDE BAR AND SAW CHAIN .....	5
– ADJUSTMENT, CHAIN TENSION .....	5
– FUEL AND LUBRICANT .....	6
STARTING AND STOPPING .....	6
– STARTING .....	6
– STOPPING .....	7
CUTTING INSTRUCTION .....	8
– GENERAL .....	8
– FELLING A TREE .....	9
– LIMBING .....	9
– BUCKING .....	10
MAINTENANCE AND CARE .....	12
– AIR FILTER .....	12
– AUTOMATIC OILER .....	12
– STRAINERS .....	12
– CARBURETOR ADJUSTMENT .....	12
– GUIDE BAR AND OIL HOLES .....	13
– SPROCKET .....	13
– SPARK PLUG .....	13
SETTING THE SAW CHAIN .....	14
TROUBLE SHOOTING .....	16
STORAGE AFTER USE .....	17
CHAIN BRAKE – .....	18

## TECHNICAL DATA

Dimension:	L x W x H	mm	370 x 240 x 220(14.6"x 9.4"x 8.7")				
Weight:	Power head, dry	kg	4.3 (w/ chain and guide bar): (9.4 lbs)				
Engine:	Type Displacement Carburetor Magneto  Spark plug Starter Power transmission	cc	Aircooled two stroke single cylinder 32.9 (2.0 cu.in.) Diaphragm type Flywheel magneto, CDI (Capacitor Discharge Ignition) system CHAMPION CJ-8Y Recoil starter Automatic centrifugal clutch				
Fuel:	Mixture ratio		Mixture of regular gasoline and air cooled two stroke engine oil. [32:1 Ratio or 50:1 Ratio with special oil approved by ECHO]				
	Tank capacity	l	0.2 (6.8 Fl.oz.US)				
Chain oil:	Tank capacity	l	Motor oil 0.14 (4.7 Fl.oz.US)				
Guide bar and saw chain:	SHIPPED IN CARTON		GUIDE BAR		CHAIN		
			Asymmetrical-Low Kick Type		Low Kick-Guard Link Type		
			Length	Part No.	Pitch	Part No.	Links
			12" *14" 16"	ECHO OREGON 12G50K 32892 14G50K 32893 16G50K 32894	3/8" 3/8" 3/8"	OREGON 91 SG 91 SG 91 SG	45 52 57
		* Standard Configuration		Or equivalent			
	Lubrication	Automatic plunger type pump, adjustable.					
STANDARD FEATURES	HAND GUARDS, FRONT AND REAR LOCKOUT, THROTTLE CONTROL MOUNTINGS, ANTI-VIBRATION		LATCH HIGH SPEED IDLE CHAIN CATCHER KICK GUARD CHAIN BRAKE				

## NOMENCLATURE OF PARTS

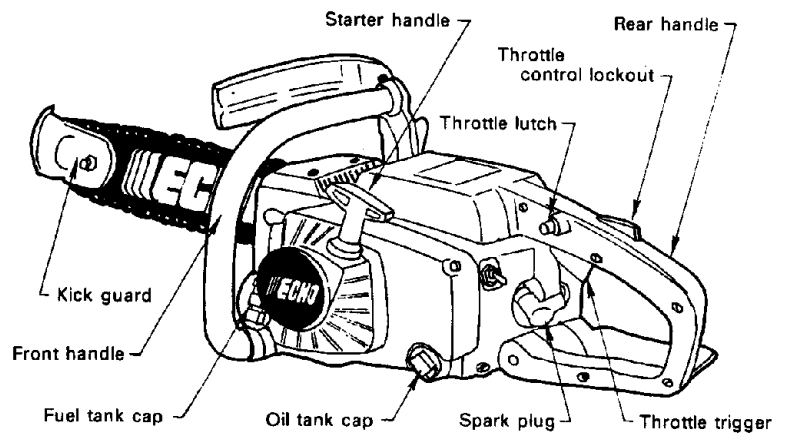
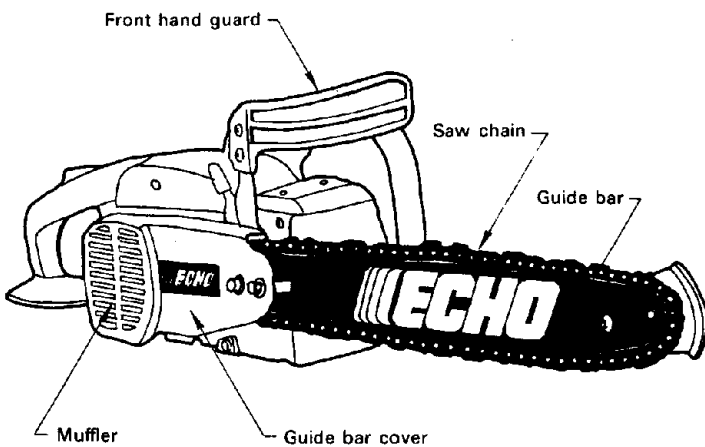

## PREPARATION FOR USE

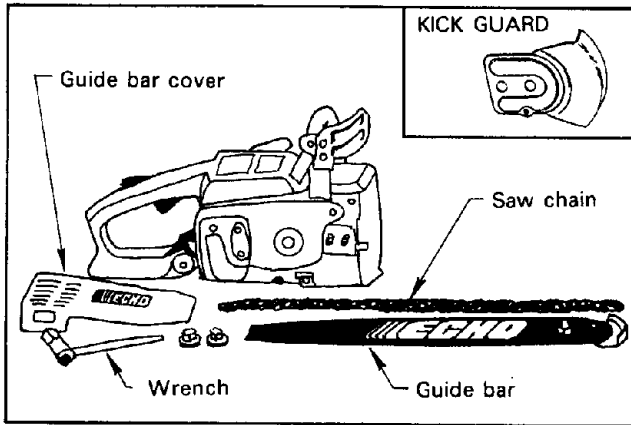

The unit is delivered with guide bar and saw chain separated. Install guide bar and chain as follows.

### WARNING

**KICKBACK IS DANGEROUS.** The low kick asymmetrical bar must be mounted with the reduced radius section of the nose on top as illustrated. Incorrect installation may result in serious or fatal injury.

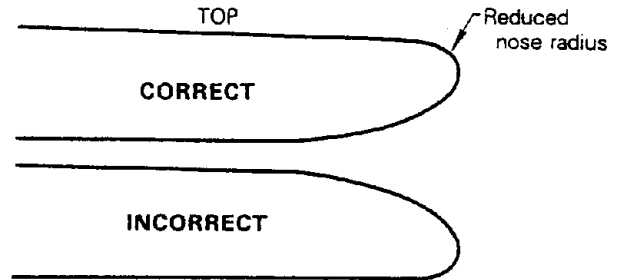

### GUIDE BAR AND SAW CHAIN

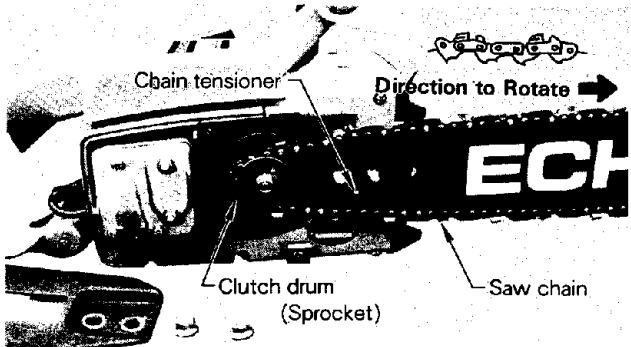

- Unscrew two nuts and remove guide bar cover.
- Mount bar and slide toward sprocket to make saw chain installation easier.
- Install chain as shown with cutters facing forward.
- Ensure that tensioner fits into bar slot.
- Install guide bar cover, tighten nuts finger tight.

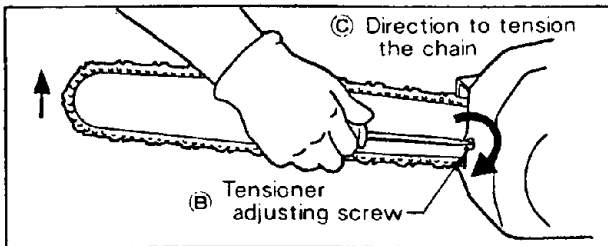

### ADJUSTMENT, CHAIN TENSION

- Turn the adjuster screw clockwise until the chain touches the bottom of the bar.
- Hold the bar nose up and tighten the chain until there is no clearance between the bar and chain tie straps.
- Tighten both nuts with the bar nose held up to eliminate clearance.
- Pull the chain around the bar by hand. Loosen the adjustment if you feel tight spots.
- Start the engine and run at low speed. Stop and readjust if necessary.

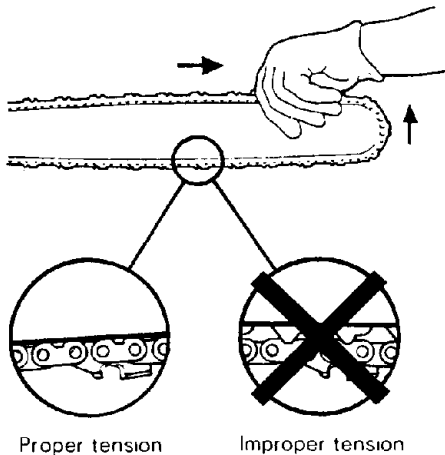

### CAUTION

1. All adjustments should be made cold.
2. Always wear gloves when working on saw chain.
3. Do not operate with a loose saw chain.

Check for loose nuts and screws on the handle, fan cover, etc. each time before using the chain saw.

## FUEL AND LUBRICANT

### FUEL

- Fuel used for this model is a mixture of Regular grade gasoline and ECHO brand motor oil or an aircooled 2 stroke engine oil of a reputable brand name.
- Mixture ratio is  
Gasoline 32 parts: Oil 1 part.
  - Fuel mixture at the rate other than 32:1 may cause malfunction of the engine.
  - Pour 1/2 the gasoline into a safe container, add the oil and mix thoroughly.
  - Now add the remainder of gasoline and mix again.
  - Do not use motor oil other than that recommended above.
  - Do not mix directly in engine fuel tank.
- After refueling, secure the fuel tank cap and wipe away all spilled fuel with a dry cloth.

#### (NOTE)

50:1 Ratio is applicable with special oil approved by ECHO.

### CHAIN LUBRICANT

- Proper lubrication of the chain while in operation reduces the friction between the chain and the guide bar to a minimum and assures a longer service life.
  - Use motor oil of high quality for this purpose.
  - Do not use used or reclaimed oil to avoid various oiler problems.
  - Use motor oil of the following grades:
    - SAE NO. 30 . . . . in summer
    - SAE NO. 10 . . . . in winter or when cutting resinous trees
  - When refueling, also refill chain oil.

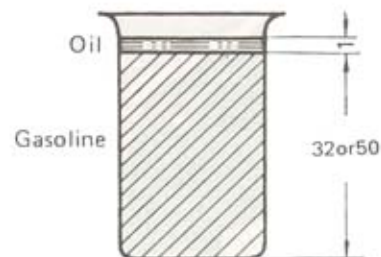

Fuel mix chart

50:1				32:1			
US		METRIC		US		METRIC	
GAS	OIL	GAS	OIL	GAS	OIL	GAS	OIL
GAL.	FL.OZ.	LITERS	CC	GAL.	FL.OZ.	LITERS	CC
1	2.6	4	80	1	4	4	125
2	5.1	8	160	2	8	8	250
5	10.2	20	400	5	20	20	625

#### Normal Use

Leaded Fuel, Regular Grade

#### Alternate or Emergency Use

Unleaded Fuels—Min. Octane 87 ( $\frac{M+R}{2}$ )

Do not Use Gasohol

## STARTING AND STOPPING

### STARTING

Make sure bar and chain are not touching anything when starting the saw.

### STARTING COLD ENGINE

- Fill the fuel tank with fuel.
- Fill the chain oil tank with lubricant.
- Turn switch to "RUN," position

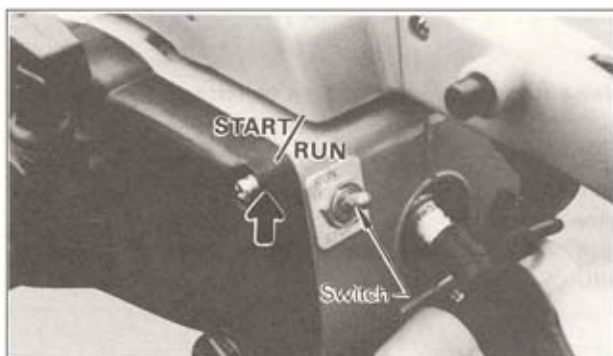

- Pull choke all the way out. (Close position)
- As squeezing throttle trigger with throttle control lock-out, pull starter handle several times until first firing sound as shown. (Hold machine with your knee.)
- Push choke all the way in. (Open position)
- Pull starter handle again.

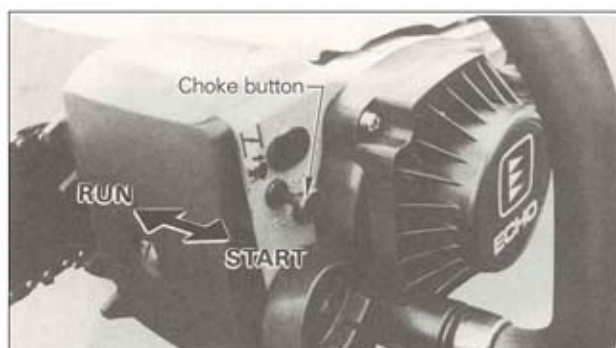

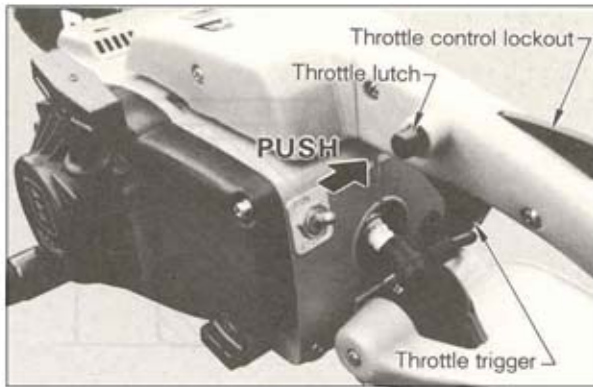

#### WHEN THE ENGINE IS HARD TO START

- Press lock down as grasping throttle trigger and push in latch as shown.
- Pull starter handle.
- When engine starts, immediately push throttle trigger up, to release the latch.

#### CAUTION

Clutch engages and chain will rotate when engine is started with throttle latch engaged. After engine starts, release throttle trigger to idle engine.

Never use the latch for cutting.

Use it only when starting the engine.



#### STARTING WARM ENGINE

- Ensure that there is fuel and chain oil in the tanks.
- Slide stop switch forward.
- Pull starter handle, as squeezing throttle trigger with throttle control lockout.
- Choke may be used if necessary but be sure to push it back on first firing sound.

Do not pull starter rope out to the maximum position.  
Do not allow recoil handle to snap back against the casing.



#### RUNNING

- After engine starts, allow it to idle for a few minutes.
- Squeeze throttle trigger with throttle control lockout gradually to increase engine speed.
- Saw chain starts running when the engine reaches approximately 3700 rpm.
- Ensure proper acceleration and lubrication of chain and bar.
- Do not run the engine at high speed unnecessarily.
- Be sure that saw chain stops moving when throttle trigger is released.

- Release throttle trigger and turn switch to STOP position.



#### (NOTE)

When engine does not stop, pull choke fully to stop engine.

Check and repair stop switch before starting the engine again.



## CUTTING INSTRUCTION

### GENERAL

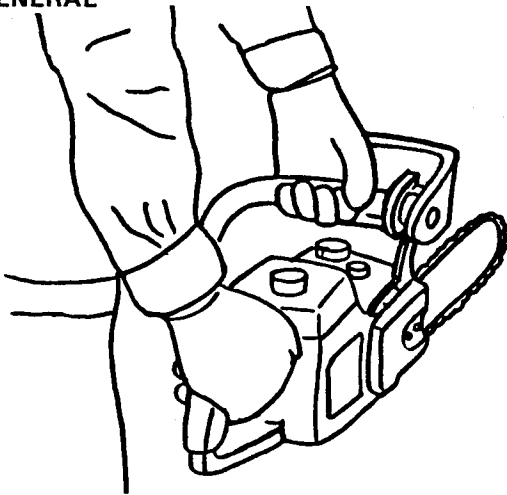

In all circumstances the operation of the chain saw is a one-man job. It is difficult at times to take care for your own safety, so don't assume the responsibility for a helper as well. After you have learned the basic techniques of using the saw, your best aid will be your own good common sense . . .

The accepted way to hold the saw is to stand to the left of the saw with your left hand on the front handlebar and your right hand on the rear handle so you can operate the throttle trigger with your right index finger.

Before attempting to fell a tree, cut some small logs or limbs. Become thoroughly familiar with the controls and the responses of the saw.

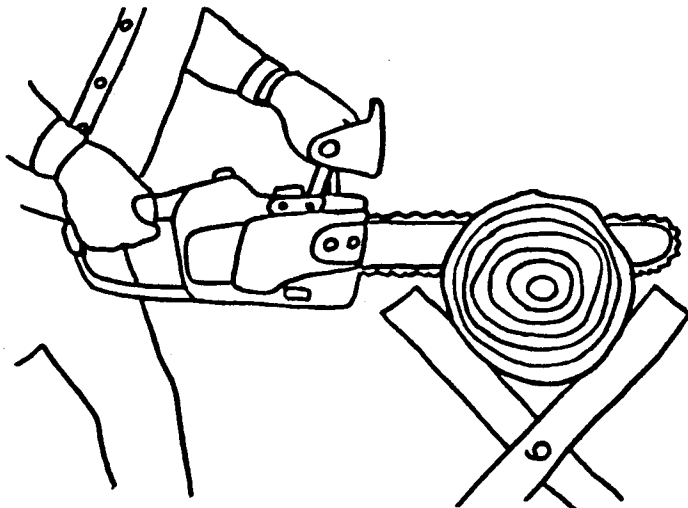

Start the engine, see that it is running properly. Squeeze the trigger to open the throttle wide open and start the cut. If the chain is properly sharpened, the cutting should be relatively effortless. It is not necessary to press down hard to make the saw cut. Pushing the saw too hard will slow the engine and cutting will actually be more difficult.

Some material may adversely affect the housings of your Echo chain saw.

(Example palm Tree Acid, fertilizer etc.) To avoid housing deterioration, carefully remove all packed saw dust around clutch and guide bar area and wash with water."

### CAUTION

Do not let the tip of the bar touch anything while the engine is running. At cutting speed the chain is moving, at a high rate of speed. Should the tip contact a limb or log while the chain is moving, the tip will be pushed upward with considerable force. This is known as kickback. Avoid it!

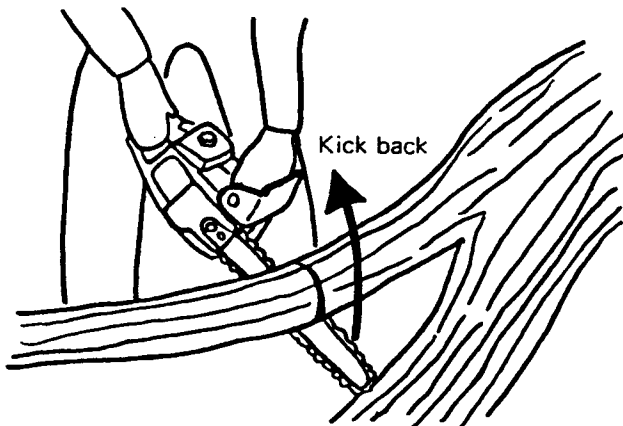

SEE OPERATOR'S MANUAL INSERT FOR INSTALLATION AND USE WITH THE KICK GUARD.

### CAUTION

Wear suitable hearing protective device such as earmuffs or earplugs to protect against objectionable or uncomfortable loud noises.

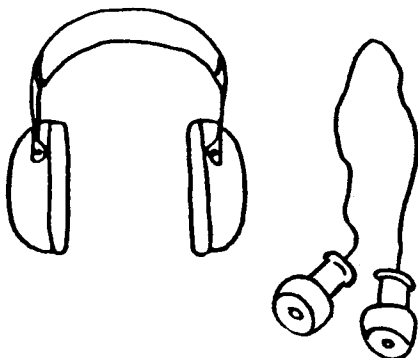

## FELLING A TREE

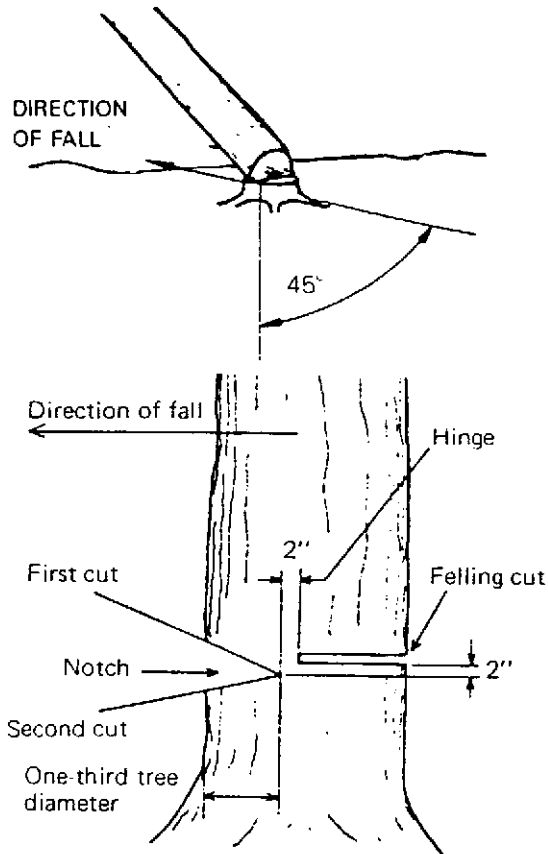

A falling tree can seriously damage anything it may hit – a car, a house, a fence, a powerline, or another tree. There are ways to make a tree fall where you want it, so first decide where that is!

**Before cutting,** clear the area around the tree. You will need good footing while working and you should be able to work the saw without hitting any obstacles. Next, select a path of retreat. When the tree begins to fall you should retreat away from the direction of fall at a 45 degree angle to avoid the trunk kicking back over the stump.

**Begin the cut on the side to which the tree is to fall.** Cut a notch about 1/3 of the way into the tree as shown. The position of this notch is important since the tree will try to fall "into" the notch. The felling out is made on the side opposite the notch and at a level about 2" above the bottom of the notch. Do not try to cut through to the notch with the felling cut. The remaining wood between the notch cut and felling cut (about 2") will act as a hinge when the tree falls, guiding it in the desired direction. When the tree starts to fall, kill the engine, place the saw on the ground and make your retreat quickly.

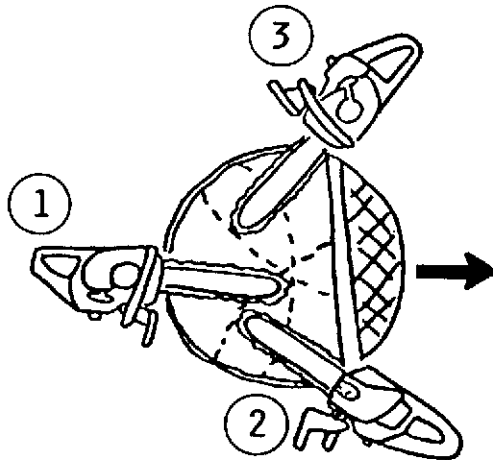

To fell big trees with a diameter exceeding twice the bar length, start the notching cuts from one side and draw the saw through to the other side of the notch. Start the back cut on one side of the tree, pivoting the saw through to form the desired hinge on that side.

Then remove the saw for the second cut. Insert the saw in the first cut, very carefully so as not to cause kickback. The final cut is made by drawing the saw forward in the cut to reach the hinge.

**SEE OPERATOR'S MANUAL INSERT FOR INSTALLATION AND USE WITH THE KICK GUARD.**

## LIMBING

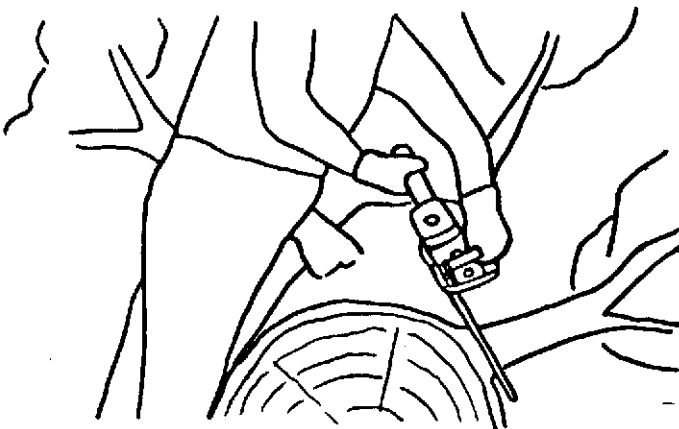

Limbing a fallen tree is much the same as bucking. Never limb on the tree that you are standing. When limbing, caution is the word. Be careful of the tip touching other limbs. Always use both hands.

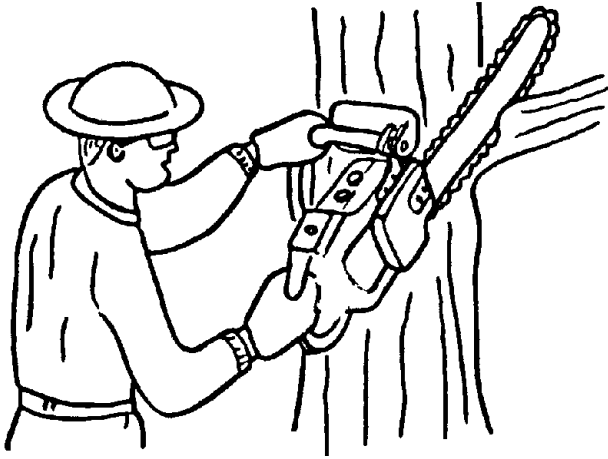

Don't cut with the saw overhead or the bar in a vertical position. If the saw should kick back you may not have good enough control to prevent possible injury.

## BUCKING

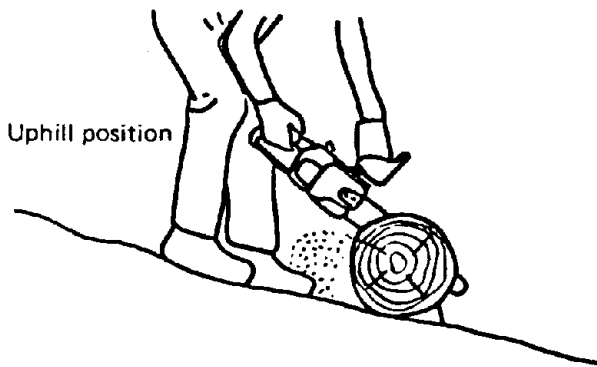

Bucking is the sawing of a log or fallen tree into smaller pieces. There are a few basic rules which apply to all bucking operations.

Keep both hands on the handles at all times.

Support logs if possible.

When cutting on a slope or hillside, always stand uphill.

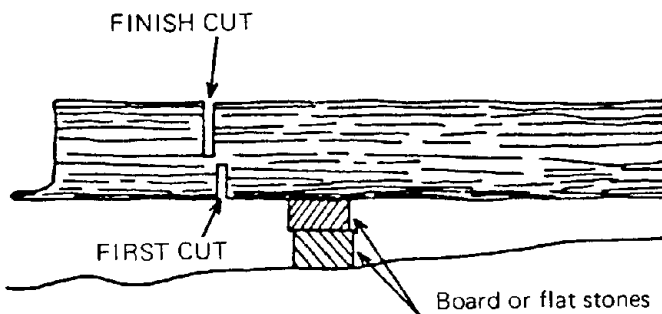

Keep in mind that the wood is heavy and that it will bend and pinch the saw if improperly supported.

The trunk will weaken at the point where you make the cut unless the tree is lying on perfectly flat ground or supported as shown.

If you make the cut with the tree on the ground, don't let the saw's chain dig into the earth; it is harmful for the saw, and you stand a good chance of being struck by flying debris. To cut the trunk, use the bucking and two-cut sequence shown. The first cut should be no deeper than one-third the trunk diameter.

## KICKBACK MOTION

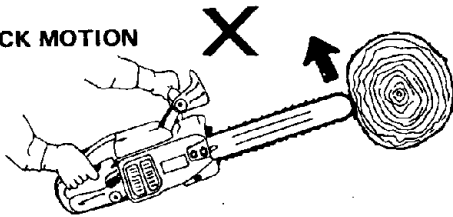

- Improper thrust cutting.

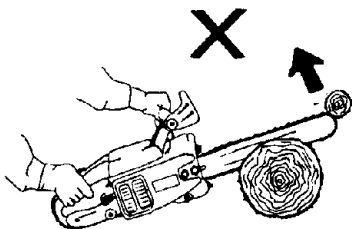

- When the bar nose hits another tree etc.

## WARNING: KICKBACK IS DANGEROUS

- Kickback is generated when the rotation of the chain is arrested for some reason. The most dangerous effect of this action occurs when the nose of the bar contacts another object, the chain is momentarily stopped and all the energy of engine throws the bar upwards and backwards towards the operator.
- The chain saw industry and government agencies have attempted to prescribe various safety devices, but the best protection is to avoid kickback.
- Comply with the Safety Precautions as listed on pages 1 of this manual.

**SEE OPERATOR'S MANUAL INSERT FOR INSTALLATION AND USE WITH THE KICK GUARD.**

## INFORMATION

### Kickback Safety Features

The following features are recommended for this model as Kickback Safety Features.

- **Asymmetrical Low Kick Type Guide Bar**

The asymmetrical low kick type guide bar must be mounted with the reduced radius section of nose on top as illustrated. Incorrect installation will result in increased kickback potential.

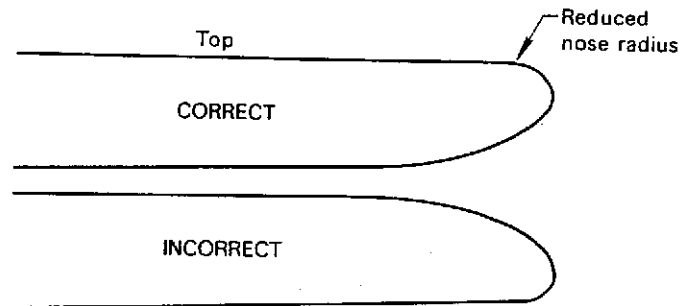

#### NOTE:

Replacement Guide Bars.

The following guide bars may be considered to have equivalent kickback energy.

- Sprocket nose guide bars of the same length and nose radius, same pitch and having the same number of teeth.
- A hard nose guide bar having the same length and nose radius as a sprocket nose bar.

- **Low Kick Guard Link Type Saw Chain**

The low kick guard link chain must be maintained correctly, follow instruction "SETTING THE CHAIN" in operator's manual.

- **Front Hand Guard**

The front hand guard must be installed correctly and kept in good condition.

- **Chain Brake**

The chain brake is available as a standard feature of the P-type model.

Chain brake must be maintained correctly, follow instruction "CORRECT USE OF CHAIN BRAKE" in operator's manual.

#### CAUTION!!

The consequences of using improper replacement components and of removing safety devices may result in serious or fatal injury.

## MAINTENANCE AND CARE

### AIR FILTER

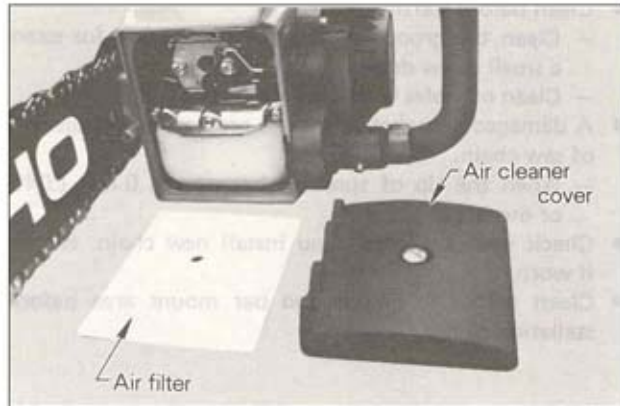

- Check before every use.
- Loosen bolt, and remove air cleaner cover and filter.
- Brush off dust lightly, or wash it in suitable cleaning fluid solvent if necessary. Dry it completely before installation.

### AUTOMATIC OILER

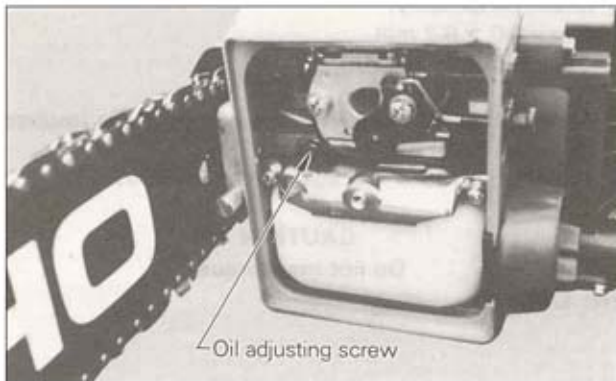

- The discharge volume of the automatic oiler is adjusted properly, prior to shipment.
- Adjustment is not necessary. When there is serious trouble, contact an ECHO distributor or dealer.
- Always clean inside of the oil tank.

### STRAINERS (Fuel and Chain oil)

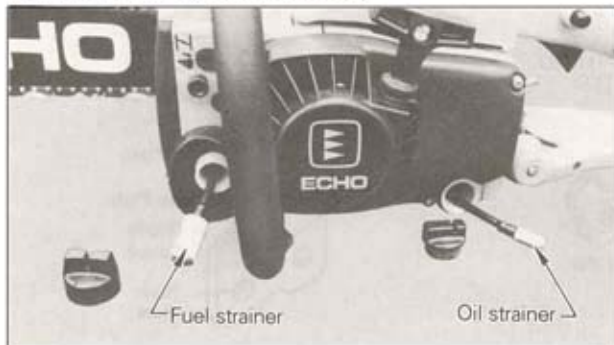

- Check periodically.
  - Do not allow dust to enter fuel tank and oil tank.
  - Clogged fuel strainer will cause difficulty in starting engine or abnormalities in engine performance.
  - Clogged oil strainer will affect the normal chain lubricating process.
  - When these strainers are dirty, pick up them through fuel and oil inlet ports with a piece of steel or the like and wash them in suitable cleaning fluid.

### CARBURETOR ADJUSTMENT

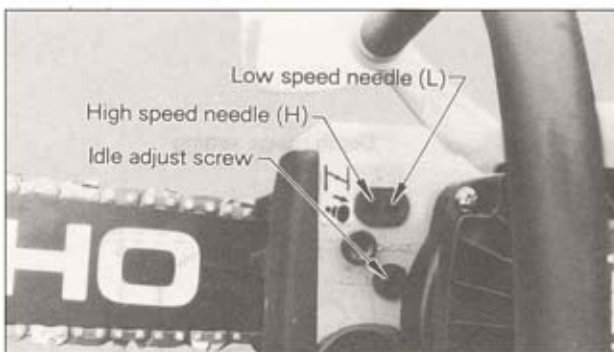

- Do not adjust the carburetor unless necessary.
- To adjust the carburetor, proceed as follows:
  - Low speed needle: (L)  $7/8 \sim 1-1/8$
  - High speed needle: (H)  $3/4 \sim 1$
  - Screw in the needles until lightly seated and return indicated turn above.
- Turn idle adjust screw clockwise until chain begins to turn, then back screw  $1/2$  turn.

#### (NOTE)

Engine must be at normal operating temperature.

**GUIDE BAR AND OIL HOLES**

**SPROCKET**

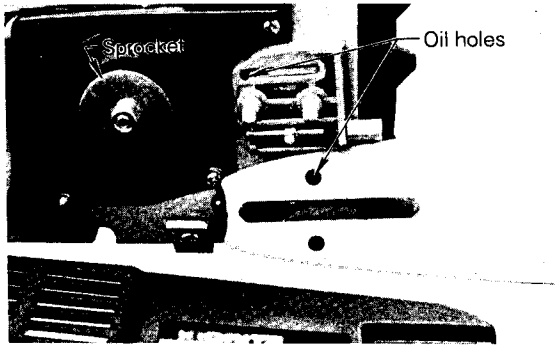

- Clean before starting work.
  - Clean the groove of the guide bar with, for example, a small screw driver.
  - Clean oil holes with a wire.
- A damaged sprocket will cause premature damage or wear of saw chain.
  - When the tip of sprocket has worn 1.0 mm (.040 in.) or more, replace it.
- Check sprocket when you install new chain. Replace it if worn.
- Clean sprocket, clutch and bar mount area before installation of bar.

**SPARK PLUG**

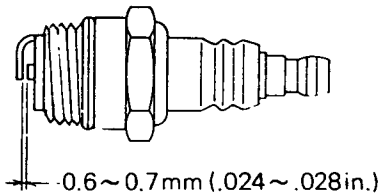

- Check periodically.
- Gap = 0.6 ~ 0.7 mm (.024" ~ .028")
- Replace if either electrode is worn or if the insulator is fouled by oil or other deposits.
- TORQUE = 145 ~ 155 kg-cm (125 ~ 135 in.lb.)

**CAUTION**  
Do not over torque.

**SETTING THE CHAIN**

**NOMENCLATURE OF PARTS**

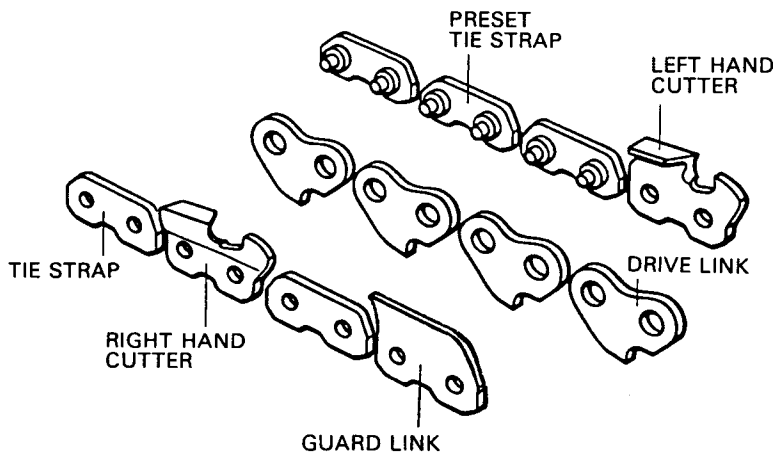

- Guard links reduce the potential of kickback.

**CUTTER PART NAMES**

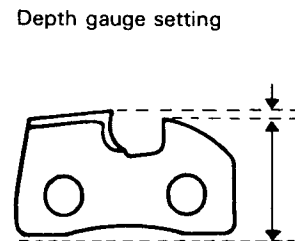
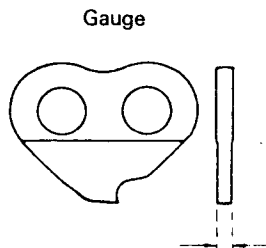
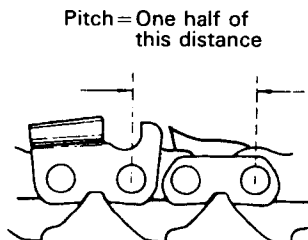
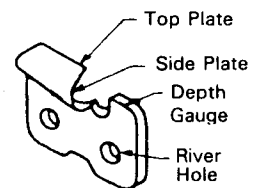

- Gauge is thickness of drive links.

- Depth gauge controls the cutting depth.

Important points for proper maintenance of saw chain:

- Keep the cutters sharp at all times.
- Keep the left and the right cutters properly aligned.
  - Please note that blunt or irregular cutters will result in poor cutting performance, increased vibration of chains and premature breakage of the saw chain.
- Drive link serves to remove sawdust from the groove of the guide bar. Therefore, keep the lower edge of the drive link indicated by the arrow, sharp.

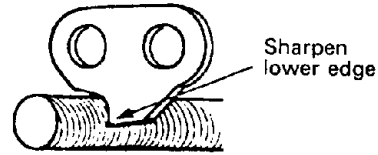
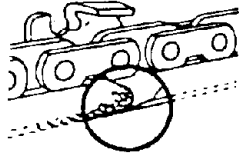

- When setting of the chain is finished, soak it in oil and wash away filings completely before using.
- When chain has been filed on the bar, supply sufficient oil to it, rotate the chain slowly to wash away the filings before using again.
- If the chain saw is operated with filings clogged in the groove, the saw chain and the guide bar will be damaged prematurely.
- If the saw chain becomes soiled with residue, clean it with kerosene and soak it in oil.

For setting saw chains, round file (4.0 mm  $\phi$ : 5/32") and flat file are used.

- To keep correct position and correct angle, use the file holder (Sure Sharp).
  - Round file (P-No. 897 510-0393 0) and flat file (P-No. 897 511-0023 0) are optional.
  - Please inquire about the file holder, if desired.

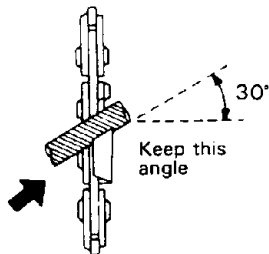

PUSH FILE AS SHOWN

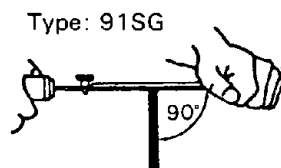

HOLD FILE HOLDER LEVEL

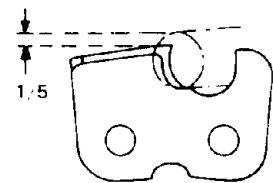

ONE FIFTH OF FILE DIAMETER REMAINS ABOVE CUTTER EDGE.

- Place the depth gauge tool firmly on guide bar so that depth gauge protrudes. Then file top of depth gauge with flat the file until flat with top of the depth gauge tool.
  - Be sure to round off the front edge of the depth gauge.

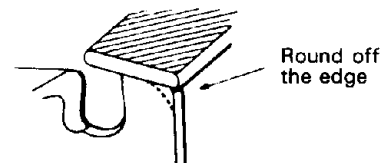
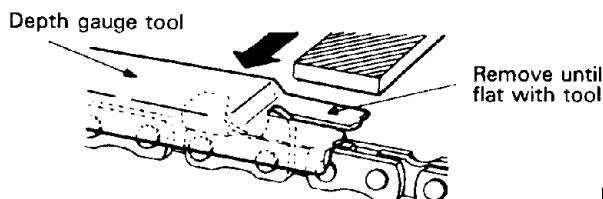

These instructions are for the Oregon 91SG saw chain.

- Properly filed cutters are shown below.

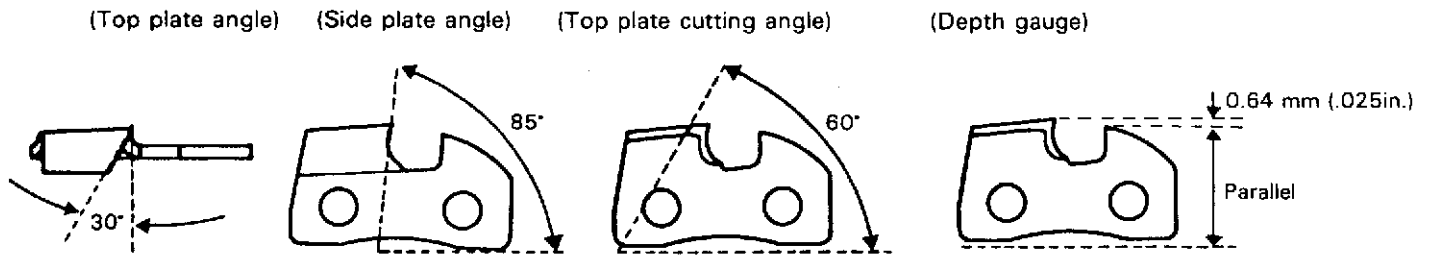

[NOTE]

To sharpen other types of saw chain, follow chain manufacturer's instruction.

## CHAIN AND GUIDE BAR COMBINATION

The following combinations are recommended to the model CS-300EVL.

Guide Bar			Saw Chain		
Length	Parts No. *		Pitch	Type *	Links
	ECHO	OREGON			
12"	12G50K	32892	3/8"	ORE. 91SG	45
14"	14G50K	32893	3/8"	ORE. 91SG	52
16"	16G50K	32894	3/8"	ORE. 91SG	57

\* Or equivalent.

REMARKS: "ORE." means "OREGON".

**CAUTION !!** Do not use replacement saw chain unless it has been designated as meeting the ANSI B 175.1 kickback performance requirements.

On specific powerhead, or has been designated as "LOW-KICKBACK" SAW CHAIN in accordance with the ANSI B 175 standard.

**NOTE:** LOW KICKBACK SAW CHAIN is the chain which has met the kickback performance requirements of ANSI B 175.1 (safety requirements for gasoline-powered chain saws) when tested on the representative sample of chain saws below 3.8 C.I.D. specified in ANSI B 175.1.



## TROUBLE SHOOTING

Poor performance of the engine and/or cutting mechanism can normally be prevented by carefully following instructions.

Poor performances can easily be corrected even by a beginner.

When the engine does not function properly check the following three (3) points first.

- Is engine compression adequate?
- Is fuel system in good condition and is enough fuel being supplied?
- Is electrical system in good condition and is spark plug operating normally?

When there is serious trouble with the unit, do not try to repair it yourself but have your distributor or dealer do it for you. For detailed **TROUBLE SHOOTING** refer to tables 1 and 2. Locate the problem on the following charts and repair as necessary.

**Table 1**

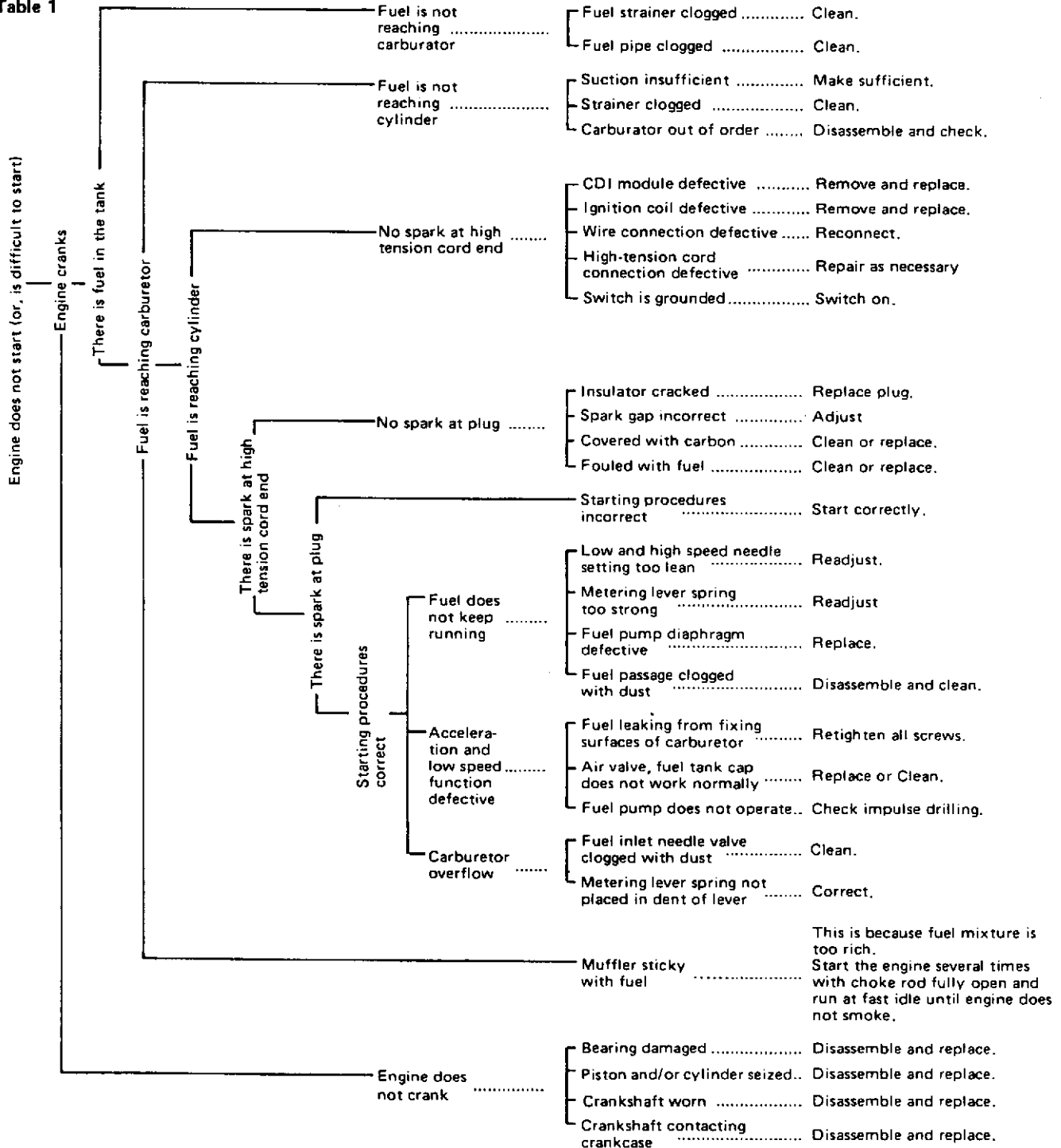
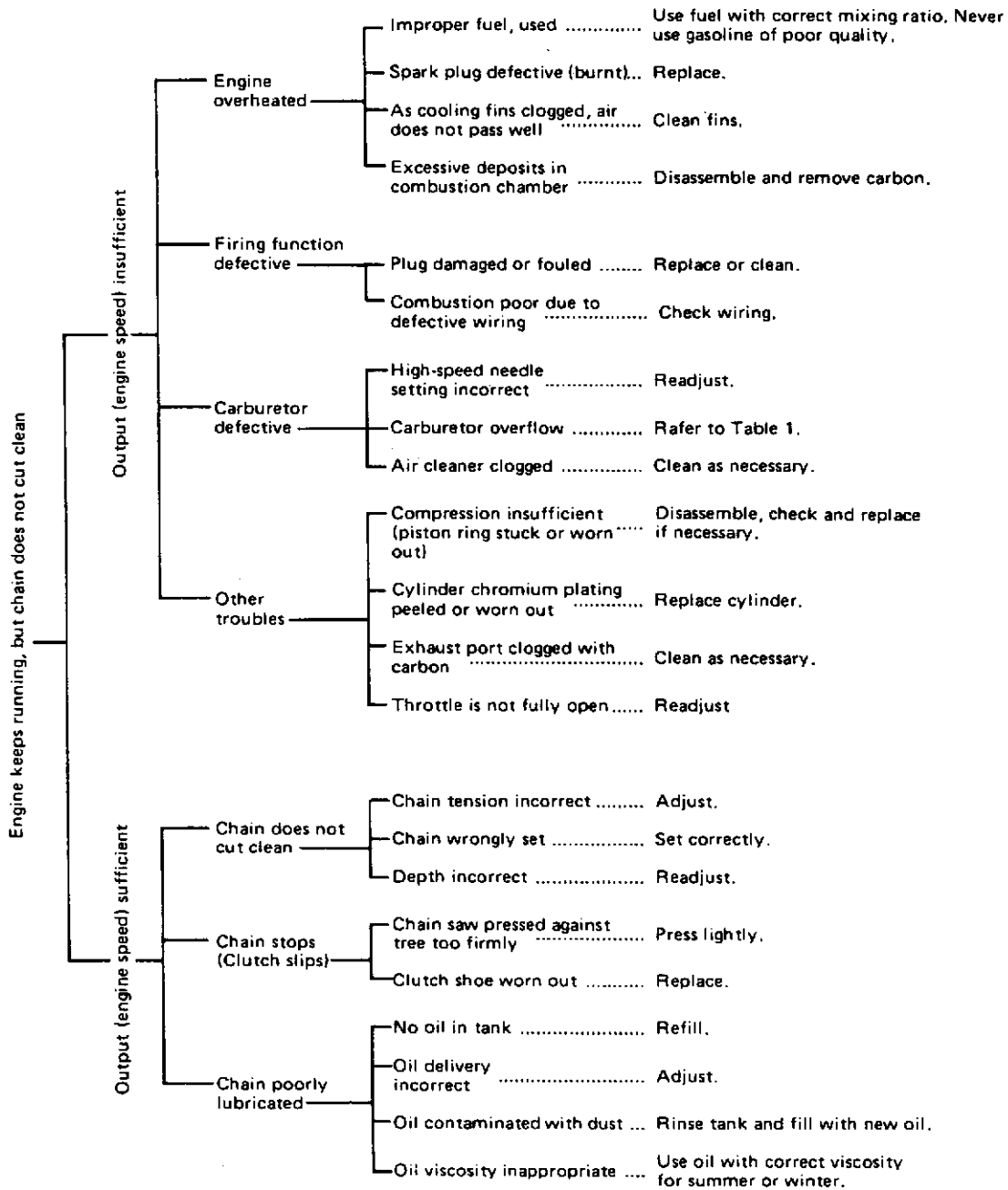

Table 2



### STORAGE AFTER USE

- Inspect and adjust every part of the chain saw.
  - Completely clean every part, and repair, if necessary.
  - Apply thin coating of oil on metal parts to prevent rust.
  - Remove chain and guide bar, apply sufficient oil coating and wrap them up in plastic.
- Drain fuel tank, pull starter slowly a few times to drain fuel from carburetor.
- Pour a small amount of clean motor oil into spark plug hole, pull starter and crank the engine until the TOP DEAD CENTER.
- Store in a dry area, free from dust.

## CHAIN BRAKE

The installation of a chain brake may be mandatory by law or as stipulated by insurance regulations in your area of operation. You should enquire through local government offices, your employer or your local dealer to ensure that your chain saw conforms to the required safety standard. Echo chain brakes have been designed and tested to comply with national safety standards as follows.

USA: ANSI Standard B 175.1 Safety Requirement for chain saws  
Canada: CSA Standard Z 62.1 Chain saws

### WARNING:

- ANSI Standard B175.1 stipulates that the brake shall stop the chain in 0.10 seconds (one tenth) at an engine speed of 8000 RPM. It is the responsibility of the Owner/Operator to ensure that the brake is serviced, adjusted and tested strictly in accordance with the instructions as detailed herein in order to ensure that the brake performance is maintained in compliance with the Standard B175.1.

### CHAIN BRAKE SERVICE

- Echo recommends that the chain brake should be serviced only by an authorized Echo servicing dealer.

### OPERATION

- The chain brake is engaged when the lever is in the forward position and is disengaged when the lever is pulled back towards the operator.
- Set the lever in the disengaged position before starting the engine. If the lever is tripped by kickback reaction, the brake will be applied to the clutch drum and will stop the chain. Immediately release the throttle to avoid possible engine and/or clutch damage.
- Do not attempt to start the engine with the brake engaged.

### MAINTENANCE

- Remove the guide bar cover.
- Remove the brake cover.
- Clean oil and sawdust from complete brake area using an oil free, non-inflammable solvent.
- Examine the brake band, drum and linkage for any indication of wear or other defect.
- Reassemble if satisfactory.

### ADJUSTMENT

- The brake does not require adjustment.

### TESTING THE BRAKE

- Start the engine on a solid level surface and run at a fast idle until warm.
- Hold the saw firmly by the handles and accelerate the engine to a fast idle.
- Slowly operate the chain brake lever while holding the saw firmly on the ground. When the brake lever trips, the chain should stop. Immediately release the throttle trigger.

### CAUTION

**DO NOT ALLOW THE SAW TO TIP FORWARD IN ORDER TO AVOID DAMAGE TO THE CHAIN.**

If the chain does not stop immediately return the saw to your authorized Echo dealer for repair.

# ECHO, INCORPORATED

400 Oakwood Road, Lake Zurich, Illinois 60047,  
Phone: 312-540-8400

## CAP INDICATION

Fuel/oil tanks are indicated by the following illustrations on the caps.

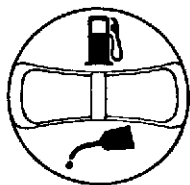

FUEL TANK CAP

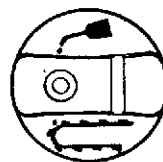

OIL TANK CAP