



Operator's Manual DPB-2500 Blower

WARNING

*Read and understand all provided literature before use.
Failure to do so could result in serious injury.*

WARNING

Cancer and Reproductive Harm www.P65Warnings.ca.gov

Note: This product complies with CAN ICES-003(B) / NMB-003(B)

99922238003

© 11/2024 ECHO Incorporated

TABLE OF CONTENTS

Introduction.....	3
Servicing Information.....	3
Parts / Serial Number.....	3
Service.....	4
ECHO Consumer Product Support.....	4
Product Registration.....	4
Additional Literature.....	4
Safety.....	5
For safe use of your product.....	5
International Symbols.....	6
Read the Manual.....	6
Clear the Work Area.....	6
Keep a Firm Grip.....	7
Keep a Solid Stance.....	7
Handling the Product.....	7
Environmentally Safe Battery Disposal.....	11
FCC Statement.....	13
Equipment.....	13
Description.....	16
Contents.....	17
Assembly.....	18
Installing the Blower Pipe.....	18
Recommended Ambient Temperature.....	18
Battery Charging.....	19
Installing and Removing the Battery.....	21
Installing the Battery.....	21
Removing the Battery.....	21
Operation.....	22
Starting Unit.....	22
Operating Blower.....	23
Maintenance.....	24
Skill Levels.....	25
Maintenance Intervals.....	25
Maintenance and Care.....	26
Cleaning Battery and Battery Compartment.....	26
Troubleshooting.....	27
Storage.....	28
Storage After Use.....	28
Specifications.....	29
Warranty.....	30
Product Registration.....	33

INTRODUCTION

Specifications, descriptions and illustrative material in this literature are as accurate as known at the time of publication, but are subject to change without notice. Illustrations may include optional equipment and accessories, and may not include all standard equipment.



Read and understand all provided literature. Literature contains specifications and information for safety, operation, maintenance, storage, and assembly specific to this product. Scan QR code for more information.



For additional literature, including safety manuals where applicable, or questions regarding terms used in this manual, visit: <https://www.echo-usa.com/manuals>



SERVICING INFORMATION

Parts / Serial Number

Genuine ECHO Parts and Assemblies for your ECHO products are available only from an Authorized ECHO Dealer. When you do need to buy parts always have the Model Number and Serial Number of the unit with you. For future reference write them in the space provided below.

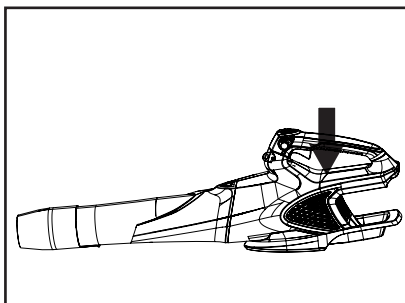

Model No. _____

Serial No. _____

Service

Service of this product during the warranty period must be performed by an Authorized ECHO Service Dealer. For the name and address of the Authorized ECHO Service Dealer nearest you, ask your retailer or call: 1-800-432-ECHO (3246). Dealer information is also available on our Web Site www.echo-usa.com. When presenting your unit for Warranty service/ repairs, proof of purchase is required.

ECHO Consumer Product Support

If you require assistance or have questions concerning the application, operation, or maintenance of this product, call the ECHO Consumer Product Support Department at 1-800-432-ECHO (3246) from 8:00 am to 5:00 pm (Central Standard Time) Monday through Friday. Before calling, please know the model and serial number of your unit.

Product Registration

Register your ECHO equipment online at www.echo-usa.com or by filling out the product registration sheet included in this manual. Registering your product confirms warranty coverage and provides a direct link to ECHO if we find it necessary to contact you.

Additional Literature

In addition to finding information online, information is available from your Authorized ECHO Service Dealer, or by contacting ECHO Incorporated, 400 Oakwood Road, Lake Zurich, IL 60047, 1-800-432-ECHO (3246).

SAFETY

For safe use of your product

Be careful to read this section before using your product.

- The precautions described in this section contain important safety information. Please observe them carefully.
- You must also read the precautions that appear in the body of the manual itself.

Throughout this manual and on the product itself, you will find safety alerts and helpful, informational messages preceded by symbols or key words. The following is an explanation of those symbols and key words and what they mean to you.

DANGER

The safety alert symbol accompanied by the word “DANGER” calls attention to an act or condition which WILL lead to serious personal injury or death if not avoided.

WARNING

The safety alert symbol accompanied by the word “WARNING” calls attention to an act or condition which CAN lead to serious personal injury or death if not avoided.

CAUTION

The safety alert symbol accompanied by the word “CAUTION” calls attention to an act or condition which might lead to minor or moderate personal injury if not avoided.

NOTICE

The enclosed message provides information necessary for the protection of the unit.









Note: This enclosed message provides tips for use, care and maintenance of the unit.



CIRCLE AND SLASH SYMBOL

This symbol means the specific action shown is prohibited. Ignoring these prohibitions can result in serious or fatal injury.

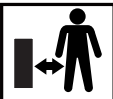
International Symbols

Symbol	Description	Symbol	Description
	WARNING! Read and follow all safety precautions in the operator's manual. Failure to follow instructions could result in serious personal injury.		Failure to keep loose clothing from being drawn into air intake could result in personal injury.
	Safety / Alert		Failure to keep long hair away from the air inlet could result in personal injury.
	Wear ear and eye protection with side shields marked to comply with ANSI Z87.1 when operating this equipment.		Disconnect battery before maintenance.
	Do not expose the product to rain or moist conditions.		Keep all bystanders at least 15 m (50') away.
	Direct current		Rotating impeller blades can cause severe injury.

Note: Not all symbols will appear on your unit.

Read the Manual

- Provide all users of this equipment with literature for instructions on safe operation.

Clear the Work Area

- Clear the area of children, bystanders, and pets. At a minimum, keep all children, bystanders, and pets outside a 15 m (50 ft.) radius; outside the 15 m (50 ft.) zone, there is still a risk of injury from thrown objects. Bystanders should be encouraged to wear eye protection. If you are approached, stop the unit.

- Avoid blowing debris towards people, pets, open windows, or vehicle when using unit.
- Review area to be cleared. Look for potential hazards such as stones or metal objects.

Keep a Firm Grip

- To prevent from dropping the unit, hold the handle in one hand, with thumb and fingers encircling the handle.

Keep a Solid Stance

- Maintain footing and balance at all times. Do not stand on slippery, uneven or unstable surfaces. Do not work in odd positions or on ladders. Do not over reach.

Handling the Product

General Safety Warnings and Instructions

This section contains the prescribed general safety warnings and instructions for battery-powered products contained in UL 2595 and for handheld tools, transportable tools and lawn and garden machinery contained in UL 62841-1. Additional important warnings and instructions are provided in subsequent sections of this manual.

Important Safety Instructions

WARNING

Read all safety warnings, instructions, illustrations, and specifications provided with this power tool. Failure to follow all instructions listed below may result in electric shock, fire, serious injury and/or property damage.

Save all warnings and instructions for future reference.

The term "power tool" in the warnings refers to your mains-operated (corded) power tool or battery-operated (cordless) power tool.

Work Area Safety

- Keep work area clean and well lit. *Cluttered or dark areas invite accidents.*
- Do not operate power tools in explosive atmospheres, such as in the presence of flammable liquids, gases or dust. *Power tools create sparks which may ignite the dust or fumes.*
- Keep children and bystanders away while operating a power tool. *Distractions can cause you to lose control.*

Electrical Safety

- Power tool plugs must match the outlet. Never modify the plug in any way. Do not use any adapter plugs with earthed (grounded) power tools. *Unmodified plugs and matching outlets will reduce risk of electric shock.*
- Avoid body contact with earthed or grounded surfaces, such as pipes, radiators, ranges and refrigerators. *There is an increased risk of electric shock if your body is earthed or grounded.*
- Do not expose power tools to rain or wet conditions. *Water entering a power tool will increase the risk of electric shock.*
- Do not abuse the cord. Never use the cord for carrying, pulling or unplugging the power tool. Keep cord away from heat, oil, sharp edges or moving parts. *Damaged or entangled cords increase the risk of electric shock.*
- When operating a power tool outdoors, use an extension cord suitable for outdoor use. *Use of a cord suitable for outdoor use reduces the risk of electric shock.*
- If operating a power tool in a damp location is unavoidable, use a ground fault circuit interrupter (GFCI) protected supply. *Use of a GFCI reduces the risk of electric shock.*

Personal Safety

- Stay alert, watch what you are doing and use common sense when operating a power tool. Do not use a power tool while you are tired, ill, or under the influence of drugs, alcohol or medication. *A moment of inattention while operating power tools may result in serious personal injury.*
- Use personal protective equipment. Always wear eye protection. *Protective equipment such as dust mask, non-skid safety shoes, hard hat, or hearing protection used for appropriate conditions will reduce personal injuries.*
- Prevent unintentional starting. Ensure the switch is in the off position before connecting to power source and/or battery, picking up or carrying the tool. *Carrying power tools with your finger on the switch or energizing power tools that have the switch on invites accidents.*

- Remove any adjusting key or wrench before turning the power tool on. *A wrench or a key left attached to a rotating part of the power tool may result in personal injury.*
- Do not overreach. Keep proper footing and balance at all times. *This enables better control of the power tool in unexpected situations.*
- Dress properly. Do not wear loose clothing or jewelry. Keep your hair, clothing and gloves away from moving parts. *Loose clothes, jewelry or long hair can be caught in moving parts.*
- If devices are provided for the connection of dust extraction and collection facilities, ensure these are connected and properly used. *Use of dust collection can reduce dust-related hazards.*
- Do not let familiarity gained from frequent use of tools allow you to become complacent and ignore tool safety principles. *A careless action can cause severe injury within a fraction of a second.*

Proper Clothing

Wear snug-fitting, durable clothing:

- Pants should have long legs, shirts should have long sleeves.
- DO NOT WEAR SHORTS.
- DO NOT WEAR TIES, SCARVES, JEWELRY, or clothing with loose or hanging items that could become entangled in moving parts or surrounding growth.
- Keep clothing buttoned or zipped, and keep shirt tails tucked in.
- Wear sturdy work shoes with nonskid rubber soles.
- Wear sturdy, no-slip, rubber work gloves to improve your grip on the handles. Gloves also provide protection against cuts and scratches, cold environments, and reduce the transmission of machine vibration to your hands.
- DO NOT WEAR OPEN TOED SHOES.
- DO NOT OPERATE UNIT WITH BARE FEET.

Power Tool Use and Care

- Do not force the power tool. Use the correct power tool for your application. *The correct power tool will do the job better and safer at the rate for which it was designed.*
- Do not use the power tool if the switch does not turn it on and off. *Any power tool that cannot be controlled with the switch is dangerous and must be repaired.*

- Disconnect the plug from the power source and/or the battery from the power tool before making any adjustments, changing accessories, or storing power tools. *Such preventive safety measures reduce the risk of starting the power tool accidentally.*
- Store idle power tools out of the reach of children and do not allow persons unfamiliar with the power tool or these instructions to operate the power tool. *Power tools are dangerous in the hands of untrained users.*
- Maintain power tools and accessories. Check for misalignment or binding of moving parts, breakage of parts and any other condition that may affect the power tool's operation. If damaged, have the power tool repaired before use. *Many accidents are caused by poorly maintained power tools.*
- Keep cutting tools sharp and clean. *Properly maintained cutting tools with sharp cutting edges are less likely to bind and are easier to control.*
- Use the power tool, accessories and tool bits etc. in accordance with these instructions, taking into account the working conditions and the work to be performed. *Use of the power tool for operations different from those intended could result in a hazardous situation.*
- Keep handles and grasping surfaces dry, clean, and free from oil and grease. *Slippery handles and grasping surfaces do not allow for safe handling and control of the tool in unexpected situations.*

Battery Tool Use and Care

- Recharge only with ECHO eFORCE® 56V battery series chargers. *A charger that is suitable for one type of battery may create a risk of fire when used with another battery.*
- Use only with ECHO eFORCE® 56V battery series. *Use of any other battery may create a risk of injury and fire.*
- When battery is not in use, keep it away from other metal objects, like paper clips, coins, keys, nails, screws or other small metal objects, that can make a connection from one terminal to another. *Shorting the battery terminals together may cause burns or a fire.*
- Under abusive conditions, liquid may be ejected from the battery; avoid contact. If contact accidentally occurs, flush with water. If liquid contacts eyes, additionally seek medical help. *Liquid ejected from the battery may cause irritation or burns.*
- Do not open or destroy the battery. *Electrolytes contained within the battery are corrosive and may cause damage to eyes or skin if released. It may be toxic if swallowed.*

- Exercise care in handling batteries to avoid shorting the battery with conducting materials such as rings, bracelets, keys, etc. *The battery or conductor may overheat and cause burns if contact with said materials is made.*
- Do not use a battery or tool that is damaged or modified. *Damaged or modified batteries may exhibit unpredictable behavior resulting in fire, explosion or risk of injury.*
- Do not expose a battery or tool to fire or excessive temperature. *Exposure to fire or temperature above 130°C (266°F) may cause explosion.*
- Follow all charging instructions and do not charge the battery or tool outside the temperature range specified in the instructions. *Charging improperly or at temperatures outside the specified range may damage the battery and increase the risk of fire.*

Service

- Do not modify or attempt to repair the appliance or the batteries (as applicable) except as indicated in the instructions for use and care.
- Have your power tool serviced by a qualified repair person using only identical replacement parts. *This will ensure that the safety of the power tool is maintained.*
- Never service damaged batteries. *Service of batteries should only be performed manufacturer or authorized service providers.*

Environmentally Safe Battery Disposal

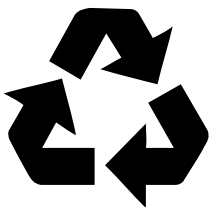

Recycle your ECHO 56V battery system batteries **FOR FREE** at Rechargeable Battery Recycling Corporation (RBRC) recycling locations. Call 1-800-822-8837 or visit <https://www.call2recycle.org> for details.

The toxic and corrosive materials below are in the batteries used in this machine: Lithium-Ion, a toxic material.

 **WARNING**

Discard all toxic materials in a specified manner to prevent contamination of the environment. Before discarding a damaged or worn out Lithium-ion battery, contact your local waste disposal agency, or the local Environmental Protection Agency for information and specific instructions. Take the batteries to a local recycling and/or disposal center, certified for Lithium-ion disposal.

 **WARNING**

If the battery cracks or breaks, with or without leaks, do not recharge it and do not use. Discard it and replace with a new battery. DO NOT TRY TO REPAIR IT! To prevent injury and risk of fire, explosion, or electric shock, and to avoid damage to the environment:

- Cover the terminals of the battery with heavy-duty adhesive tape.
- DO NOT try to remove or destroy any of the battery components.
- DO NOT try to open the battery.
- *If a leak develops, the released electrolytes are corrosive and toxic. DO NOT get the solution in the eyes or on skin, and do not swallow it.*
- DO NOT put these batteries in your regular household trash.
- DO NOT incinerate.
- DO NOT put them where they will become part of any waste landfill or municipal solid waste stream.
- Take them to a certified recycling or disposal center.

FCC Statement

This device complies with Part 15 of the FCC Rules. Operation is subject to the following two conditions:

- This device may not cause harmful interference.
- This device must accept any interference received, including interference that may cause undesired operation.

CAUTION

Changes or modifications not expressly approved by the party responsible for compliance could void the user's authority to operate equipment.

NOTICE

This equipment has been tested and found to comply with the limits for a Class B digital device, pursuant to Part 15 of the FCC Rules.

These limits are designed to provide reasonable protection against harmful interference in a residential installation. This equipment generates, uses and can radiate radio frequency energy, and if not installed and used in accordance with the instructions, may cause harmful interference to radio or television reception. The reception can be determined by turning the equipment off and on. The user is encouraged to try to correct the interference by one or more of the following measures:

- Reorient or relocate the receiving antenna.
- Increase the separation between the equipment and the receiver.
- Connect the equipment into an outlet on a circuit different from that to which the receiver is connected.
- Consult the dealer or an experienced radio/TV technician for help.

Equipment

WARNING

Use only approved attachments. Serious injury can result from the use of a non-approved attachment combination. ECHO Incorporated will not be responsible for the failure of cutting devices, attachments or accessories which have not been tested and approved by ECHO. Read and comply with all safety instructions listed in this manual.

- ◆ Do not attempt to modify this product. Serious injury can result from the use of any modified product.
- ◆ Check unit for loose/missing nuts, bolts, and screws. Tighten and/or replace as needed.
- ◆ Do not use blower if any part is missing or damaged.
- ◆ Have repairs done only by an authorized service dealer.

WARNING

Moving parts can amputate fingers or cause severe injuries. Keep hands, clothing and loose objects away from all openings.

- ◆ *ALWAYS stop unit, remove battery, and make sure all moving parts have come to a complete stop before removing obstructions, clearing debris, or servicing unit.*
- ◆ *DO NOT start or operate unit unless all guards and protective covers are properly assembled to unit. Do not use blower if any part is missing or damaged.*
- ◆ *NEVER reach into any opening while the unit is running. Moving parts might not be visible through openings.*

General Safety Warnings and Instructions for the following ECHO tool: Blower or DPAS unit configured as Blower.

This section contains the prescribed general safety warnings and instructions for motor-operated electric garden blowers contained in UL standards 62841-4-6. Additional important warnings and instructions are provided in subsequent sections of this manual.

Save all warnings and instructions for future reference.

WARNING

Read all safety warnings, instructions, illustrations and specifications provided with this power tool. Failure to follow all instructions listed below may result in electric shock, fire and/or serious injury.

WARNING

Garden blower safety warnings:

1. **Do not use the machine in bad weather conditions, especially when there is a risk of lightning.** This decreases the risk of being struck by lightning.
2. **Wear eye protection and ear protection.** Adequate protective equipment will reduce the risk of personal injury.
3. **While operating the machine, always wear non-slip and protective footwear. Do not operate the machine when barefoot or wearing open sandals.** This reduces the risk of injury to the feet.
4. **Do not wear loose fitting clothing or articles such as scarves, strings, chains, ties, etc., that could get drawn into the air inlets. Tie back or cover long hair to make sure it does not get drawn into the air inlets.** If any of these items are drawn into the air inlets, it can increase the risk of personal injury.
5. **Keep bystanders away while operating the machine.** Thrown debris can increase the risk of personal injury.
6. **Never point the blower nozzle in the direction of people or pets or in the direction of windows. Use extra caution when blowing debris near solid objects, such as trees, automobiles and walls that can cause debris to ricochet.** Thrown objects can damage property and increase the risk of personal injury.
7. **Do not use the machine to blow anything that is burning or smoking, such as cigarettes, matches or hot ashes.** These ignition sources may increase the risk of fire.
8. **Do not touch the fan while still in motion. Turn off the machine, wait until the fan stops and unplug the machine, before removing any part that may give access to the fan.** This reduces the risk of injury from moving parts.
9. **When clearing jammed material or servicing the machine, make sure the power switch is off.** Unexpected actuation of the machine while clearing jammed material or servicing may increase the risk of personal injury.

DESCRIPTION

Locate the safety label(s) on your unit. Make sure the label(s) is legible and that you understand and follow the instructions on it. If a label cannot be read, a new one can be ordered from your ECHO dealer. Safety label is for example only. Your label may appear slightly different.

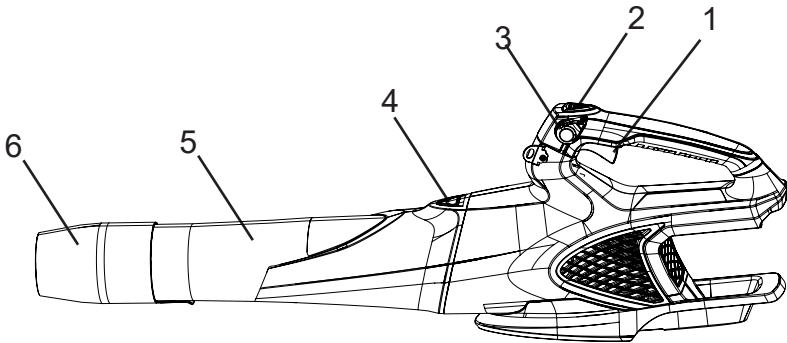

household use only. For use only with ECHO eFORCE 56V battery series. See operator's manual for list of compatible model numbers. Store indoors only, avoid moisture or water.

L'utilisateur doit lire et comprendre le temps de comprendre le mode d'emploi afin de réduire le risque de blessures. Pour réduire le risque de choc électrique, retirez la batterie avant de la nettoyer ou de faire l'entretien, ne pas exposer à la pluie. Pour usage domestique seulement. À utiliser uniquement devant de batteries ECHO eFORCE 56V. Voir le manuel de l'opérateur pour la liste des numéros de modèle compatibles. Rapporter au manuel d'instruction pour des batteries additionnelles. Entroposer à l'intérieur seulement, à l'abri de l'humidité ou de l'air saleté.

Para reducir el riesgo de lesiones, el usuario debe leer y entender este manual de instrucciones. Para reducir el riesgo de descargas eléctricas, retire la batería antes de limpiarla o repararla, no la exponga a la lluvia. Solo para uso doméstico. Solo para uso con la serie de baterías ECHO eFORCE 56V. Consulte el manual del operador para ver la lista de números de modelos compatibles. Consulte información acerca de módulos de baterías adicionales en el manual de instrucciones. Guarde solo en el interior. Evite exponerlo a la humedad o al agua.



DPB-2500

56V

**HANDHELD BLOWER
SOUFFLEUR À MAIN
SOPLADOR DE MANO**



Made in Vietnam
Fabriqué au Vietnam
Hecho en Vietnam



CAN ICES-003(B) / NMB-003(B)





ECHO Incorporated
400 Oakwood Road
Lake Zurich, IL 60047

Conforms to UL STD. /
Conforme aux normes UL STD. /
Conformado a UL STD.
62841-1 & 62841-4-6
Certified to CSA STD. /
Certifié selon la norme CSA STD. /
Certificado según la norma CSA STD.
CSA C22.2 No. 62841-1 &
CSA C22.2 No. 62841-4-6

1-800-432-3246







UL
504



Intertek
5021526

Build date:

SN:

1. Power switch
2. Turbo button
3. Cruise control lever
4. Pipe release button
5. Pipe
6. Concentrator nozzle

CONTENTS

The ECHO product you purchased has been factory pre-assembled for your convenience. Due to packaging restrictions, some assembly may be necessary.

After opening the carton, check for damage. Immediately notify your retailer or ECHO Dealer of damaged or missing parts. Use the contents list to check for missing parts.

- 1 Blower
- 1 Pipe
- 1 Operator's Manual
- 1 Concentrator Nozzle

NOTICE

For a complete list of compatible batteries for this and all ECHO 56V battery system tools, scan this code or visit <https://www.echo-usa.com/battery-information>



ASSEMBLY

Installing the Blower Pipe

- Slide pipe (5) onto blower body until pipe release button (4) engages with hole in pipe. Press pipe release button and slide pipe off blower body to remove.

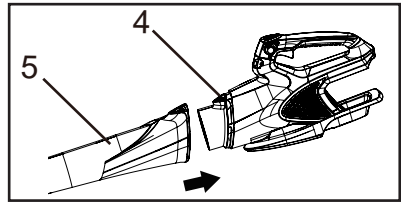

- Connect the concentrator nozzle (6) to the pipe (5) until the pipe locks into the concentrator nozzle (6).

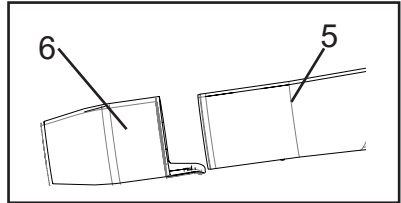

Recommended Ambient Temperature:

	Charging		Usage/Discharging		Storage	
	Low	High	Low	High	Low	High
Product ⁽¹⁾	Not Applicable		32°F (0°C)	113°F (45°C)	32°F (0°C)	113°F (45°C)
Battery ⁽²⁾⁽³⁾	39°F (4°C)	104°F (40°C)	32°F (0°C)	113°F (45°C)	32°F (0°C)	113°F (45°C)
Charger	39°F (4°C)	104°F (40°C)	Not Applicable		32°F (0°C)	113°F (45°C)

⁽¹⁾ Assumes the battery is just off the charger or stored at the temperature range noted for Charger Usage 39° F (4°C) - 104°F (40°C).

⁽²⁾ Hot batteries in high ambient temperatures require longer charge times.

⁽³⁾ To maximize battery life of batteries being stored more than 3 months, ECHO recommends batteries being stored at 3 green lights on the battery capacity indicator (BCI) at an ambient temperature of 60°F (16°C) - 80°F (27°C), and not in direct sunlight.

Note: Long term storage of batteries in conditions or charge levels on the battery capacity indicator (BCI) other than noted above could reduce the performance and runtime of the battery.

Battery Charging

NOTICE

See separate operator's manuals packaged with battery and charger.

WARNING

- Use only with ECHO eFORCE® 56V battery series batteries and chargers.
- Keep charger and battery away from damp conditions and all liquids.
- Do not operate the charger on an easily combustible surface (e.g. paper, textiles) or in an environment with a high risk of fire.
- Do not cover the charger. Covering the charger will prevent it from cooling.
- Do not operate the charger in explosive atmospheres, such as in the presence of flammable liquids, gases or dust. Charger can produce sparks which may ignite the dust or fumes - there is a risk of explosion.
- Connect the charger only to the mains of voltage and frequency specified on the rating plate.
- Connect the charger only to an easily accessible wall outlet.
- Never insert objects in the battery's or charger's cooling slots.
- Do not charge or use a defective, damaged or deformed battery and charger.
- Do not open, damage or drop the battery or the charger.
- Fluid may leak from the battery if it is damaged or not used properly; avoid contact with the skin. In the event of accidental contact, wash the affected areas of the skin with plenty of water and soap. If fluid gets in the eyes, do not rub. Rinse the eyes with plenty of water for at least 15 minutes. Also seek medical assistance.
- Never bridge (short circuit) the battery contacts or the charger's terminals with metallic objects.
- Protect from direct sunlight, heat and open flames and never throw battery into fire; there is a risk of explosion.
- In the event of smoke or fire in the charger, disconnect it from the wall outlet immediately.
- If the connecting cord is damaged, immediately disconnect the plug from the power supply to avoid the risk of electric shock.
- Do not expose battery to microwaves or high pressure.
- To reduce the risk of stumbling, position and mark the connecting cord in such a way that it cannot be damaged or endanger others.

NOTICE

The battery comes partially charged from the factory and needs to be fully charged before first use. Charge the battery when it no longer produces sufficient power to operate the unit or when battery lights indicate that the battery is low.

1. Plug charger AC cord in the wall outlet.
2. Align ridges on battery with grooves on charger, and slide battery into charger.
3. During normal charging, the charger LED (A) will blink GREEN.

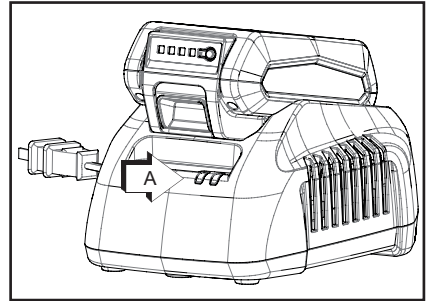

NOTICE

If charger detects a problem, LED will blink RED. Remove battery from charger, clear obstructions from contacts and reinstall battery into charger. If battery is outside acceptable temperature range (See Recommended Ambient Temperature chart) LED will remain RED.

4. When charging is complete, LED will remain GREEN. See battery manual for charging time.
5. Verify battery is fully charged. Remove battery from charger, press battery charge status button (B), and check LED display.
 - One green light indicates that the battery has 1-24% charge.
 - Two green lights indicate that the battery has 25-54% charge.
 - Three green lights indicate that the battery has 55-79% charge.
 - Four green lights indicate that the battery has 80-100% charge.
6. Unplug charger AC cord from the wall outlet.

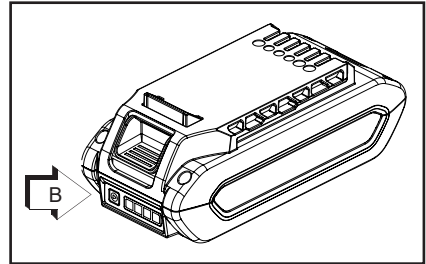

Installing and Removing the Battery

WARNING

The blower will operate when the battery is installed. Make sure the blower is properly positioned to prevent loss of control and possible serious injury.

Note: Battery comes partially charged from the factory and needs to be fully charged before first use.

Installing the Battery

1. Align ridges on the sides of the battery (7) with the grooves in the battery compartment (8).
2. Push the battery (7) into the battery compartment (8) until the battery (7) locks into place.
3. When you hear a click, the battery (7) is installed.

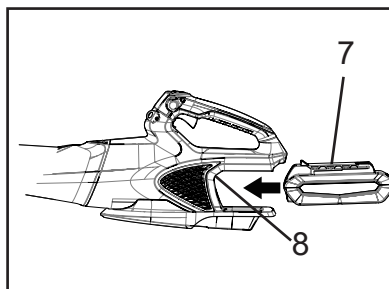

NOTICE

Ensure battery is fully locked into place before using the unit.

WARNING

- If the battery or charger is damaged, replace the battery or the charger.
- Stop the machine and wait until the motor stops before you install or remove the battery.
- Read and understand the instructions in the battery and charger manual.

Removing the Battery

1. Push and hold the battery release button.
2. Remove the battery from the machine.

OPERATION

Starting Unit

WARNING

The blower will operate when the battery is installed. Make sure the blower is properly positioned to prevent loss of control and possible serious injury.

WARNING

Make sure the blower pipe is in position before operation.

1. Power Switch

Pull power switch to start the machine and increase the speed.

Release power switch to decrease the speed or turn machine off.

2. Cruise Control Lever

Pull cruise control lever clockwise to increase the speed. This will lock the speed at the desired setting.

Push cruise control lever counter clockwise to decrease the speed.

To restore the original speed, you need to manually rotate the cruise control lever.

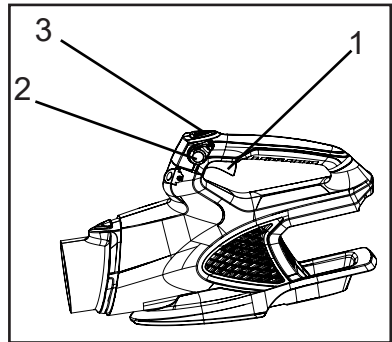

3. Turbo Button

Push turbo button to boost machine to highest possible speed.

Push turbo button again to return machine to normal speed.

NOTICE

Turbo button drains battery faster than normal use.

Operating Blower

WARNING

Always wear safety glasses, hearing protection and a face filter mask or serious personal injury may result. Do not point the blower pipe in the direction of people or pets.

Read the Safety Section carefully.

NOTICE

To avoid damage to the unit due to over-revving, do not block blower pipe.

1. Use lower speed to blow dry leaves from walks, patios and drives. Use rakes and brooms to loosen debris before blowing.
2. Additional speed may be necessary to clean grass and leaves from a lawn or flower bed.
3. Higher speed may be necessary to move gravel, dirt, snow, bottles or cans from a driveway, street, parking lot or stadium.

Note: Never use a higher speed setting than necessary to perform a task. Remember, the higher the engine speed, the louder the blower noise.

4. Minimize dust by using blower at lower speeds or dampen surface with water. Blower can be used to clean most surfaces when water conservation is desired.
5. Use the full blower pipe configuration when blowing.
6. After using blowers and other equipment, CLEAN UP! Dispose of debris in trash receptacles.

CAUTION

Contacting blower pipe tip on abrasive surfaces can create sharp cutting edges and can result in personal injury if touched. Do not scrape or drag blower pipe tip when operating or transporting unit.

MAINTENANCE

 WARNING

Moving parts can amputate fingers or cause severe injuries. Keep hands, clothing and loose objects away from all openings. Always stop unit and make sure all moving parts have come to a complete stop before removing obstructions, clearing debris, or servicing unit. Allow unit to cool before performing service. Wear gloves to protect hands from sharp edges and hot surfaces.

 WARNING

Operating a poorly maintained unit can result in serious injuries to operator or bystanders. Always follow all maintenance instructions as written, otherwise serious personal injury can result.

Your unit is designed to provide many hours of trouble free service. Regular scheduled maintenance will help your unit achieve that goal. If you are unsure or are not equipped with the necessary tools, we recommend that you take your unit to a ECHO Dealer for maintenance.

To help you decide whether you want to DO-IT-YOURSELF or have the Dealer do it, each maintenance task has been graded. If the task is not listed, see your Dealer for repairs.

 CAUTION

Do not let brake fluids, gasoline, petroleum-based materials touch the plastic parts. Chemicals can cause damage to the plastic, and make the plastic unserviceable.

 CAUTION

Do not use strong solvents or detergents on the plastic housing or components.

 WARNING

Remove the battery from the machine before maintenance.

Skill Levels

Level 1 = Easy to do. Common tools may be required.

Level 2 = Moderate difficulty. Some specialized tools may be required.

Level 3 = See your dealer.

Maintenance Intervals

COMPONENT/ SYSTEM	MAINTENANCE PROCEDURE	SKILL LEVEL	INTERVAL
Screws/Nuts/Bolts	Inspect/Tighten/ Replace	1	Before Each Use
Battery and Battery Compartment	Inspect / Clean	1	Before Each Use

 **WARNING**

If not maintained properly, the product may pose a serious risk to physical health.

NOTICE

If not maintained properly, the product's performance may deteriorate. Time intervals shown are maximum. Actual use and your experience will determine the frequency of required maintenance. When you find anything wrong, ask your ECHO dealer for repair.

Maintenance and Care

WARNING

Remove battery before performing maintenance procedures.

WARNING

Risk of electric shock or fire. Do not use conducting materials to clean battery or battery compartment. Otherwise serious personal injury may result.

Cleaning Battery and Battery Compartment

CAUTION

The machine must be dry. Humidity can cause risks of electrical shocks.

1. Clear the unwanted material out of the air vent with a vacuum cleaner.
2. Do not spray the air vent or put the air vent in solvents.
3. Clean the battery compartment (8) and the plastic components with a moist and soft cloth.

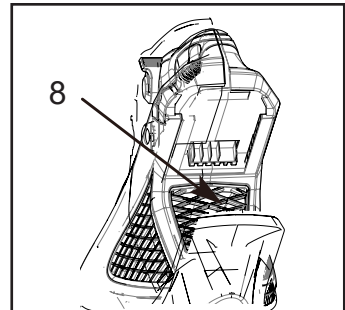

TROUBLESHOOTING

Problem	Cause	Solution
The motor does not start when you pull the power switch.	The batteries are not installed tightly.	Make sure that you tightly install the batteries in the machine.
	The batteries are out of power.	Charge the batteries.
	The power switch is defective.	Replace the defective parts, call an Authorized ECHO Dealer
	The motor is defective.	
The air does not flow through the pipe when you start the machine.	The air inlet or pipe outlet has a blockage.	Remove the blockage.

STORAGE

Storage After Use

When storing the product for long periods of time, ensure that the following preparations for storage are carried out.

Blower

Do not store your unit without performing protective storage maintenance which includes the following:

1. Clean the unit before storage.
2. Remove battery from blower.
3. Remove accumulation of dirt and debris from exterior of unit.
4. Tighten all screws and nuts.
5. Replace the damaged parts.
6. Cover battery compartment of blower.
7. Store unit in a dry, dust-free place, out of the reach of children.

Battery

1. Remove battery from blower.
2. Store in a dry, dust-free place, out of the reach of children.
3. Store in temperatures consistent with ambient temperature chart.
4. Charge battery according to ambient temperature chart.

Charger

1. Remove battery from charger.
2. Disconnect charger from power supply.
3. Store in a dry, dust-free place, out of the reach of children.

SPECIFICATIONS

MODEL	DPB-2500
Voltage	56 V DC
Air volume	580 CFM
Air speed	150 MPH
Length (without blower pipes)	506 mm (19.92")
Width (without blower pipes)	302 mm (11.89")
Height (without blower pipes)	160 mm (6.3")
Weight (without battery and charger)	6.66 lbs (3.02 kg)
Battery:	
Model	ECHO eFORCE® 56V battery series batteries
Type	Li-Ion
Voltage	56V DC (Rated 50.4V DC)
Charger type	CC-CV
Charger input voltage	120V AC 60Hz
Charger model	ECHO eFORCE® 56V battery series charger
Charger Lights	
<input type="radio"/> OFF <input checked="" type="radio"/> Green blinking	Battery is charging
<input type="radio"/> OFF <input checked="" type="radio"/> Green	Fully charged
<input checked="" type="radio"/> Red <input type="radio"/> OFF	Battery is too warm: (Remove for approx.30 minutes to allow to cool)
<input checked="" type="radio"/> Red blinking <input type="radio"/> OFF	Defective battery: (Remove and replace with new battery if this occurs)
Charge Time	See Battery Operator's Manual

Limited Warranty Statement for ECHO 56 Volt Handheld Products and Walk Behind Mowers sold in USA and Canada

ECHO Incorporated warrants to the original retail purchaser that this ECHO brand 56 Volt outdoor product is free from defects in material and workmanship and agrees to repair or replace, at ECHO Incorporated's discretion, any defective product free of charge within these time periods from the date of purchase:

- If the product is for homeowner use:
 - Units and Bare Tool – 5 Years
 - Battery or charger – 2 years
- If the product is for commercial use:
 - Units and Bare Tool – 2 years
 - Battery or charger – 2 years
- If the product is for rental use: 90 days for all units, batteries, and chargers.
- Cutting attachments such as, but not limited to, bars, chains, sprockets, blades, tines, belts, PowerBroom™ and nylon trimmer heads for homeowner or non-income producing use will be covered for failures due to defects in material or workmanship for a period of 60 days from original product purchase date and 30 days for commercial / rental use. Any misuse with concrete, rocks, or other structures is not covered by this warranty.

This warranty extends to the original retail purchaser only and commences on the date of the original retail purchase.

Any part of this product found in the reasonable judgment of ECHO Incorporated, to be defective in material or workmanship will be repaired or replaced without charge for parts and labor by an authorized ECHO dealer. Units, repair parts and accessories replaced under this warranty are warranted only for the balance of the original warranty period.

The product, including any defective part, must be returned to an authorized ECHO dealer within the warranty period. The expense of delivering the product to the service center for warranty work and the expense of returning it back to the owner after repair or replacement will be paid by the owner. ECHO Incorporated's, responsibility in respect to claims is limited to making the required repairs or replacements and no claim of breach of warranty shall be cause for cancellation or rescission of the contract of sale of any ECHO brand 56 Volt outdoor product. Proof of purchase will be required by the dealer to substantiate any warranty claim. All warranty work must be performed by an authorized ECHO dealer.

This warranty does not cover any units, battery or charger that has been subject to misuse, neglect, negligence, or accident, or that has been operated in any way contrary to the operating instructions as specified in the Operator's Manual.

This warranty does not cover normal deterioration due to the use or exposure, and any repairs made necessary by normal wear, improper maintenance, improper lubrication, improper storage, dirt, abrasives, impact, moisture, water, rain, snow, rust, corrosion, varnish, or other similar conditions.

This warranty does not cover damage to chargers or batteries by improper charging voltage and batteries that have been exposed to temperatures beyond those specified in the Operator's Manual, batteries that have not been properly charged or batteries that have reached their useful life.

This warranty does not apply to any damage to the product that is the result of improper maintenance or to any product that has been altered or modified. The warranty does not extend to repairs made necessary by normal wear or by the use of parts or accessories which are either incompatible with the ECHO brand 56 Volt outdoor product or adversely affect its operation, performance, or durability. In addition, this warranty does not cover wear to normal items such as, but not limited to:

Wear items – Bump Knobs, Outer Spools, Cutting Lines, Inner Reels, Felt Washers, Hitch Pins, Mulching Blades, Blower Fans, Blower and Vacuum Tubes, Vacuum Bag and Straps, Guide Bars, Saw Chains, Grass Catch Bag, Hedge Trimmer Blades, and Wheels

ECHO Incorporated, reserves the right to change or improve the design of this product without assuming any obligation to modify any product previously manufactured.

All implied warranties are limited in duration to the stated warranty period. Accordingly, any such implied warranties including merchantability, fitness for a particular purpose, or otherwise, are disclaimed in their entirety after the expiration of the appropriate five-year, two-year, one-year, 90-day, 60-day, or 30-day warranty period. ECHO Incorporated's obligation under this warranty is strictly and exclusively limited to the repair or replacement of defective parts. ECHO Incorporated, does not assume or authorize anyone to assume for them any other obligation. Some states do not allow limitations on how long an implied warranty lasts, so the above limitation may not apply to you. ECHO Incorporated, assumes no responsibility for incidental, consequential, or other damages including, but not limited to, expense of returning the product to an authorized dealer for ECHO brand 56 Volt outdoor products and expense of delivering it back to the owner, mechanic's travel time, telephone charges, rental of a like product during the time warranty service is being performed, travel, loss or damage to personal property, loss of revenue, loss of use of the product, loss of time, or inconvenience. Some states do not allow the exclusion or limitation of incidental or consequential damages, so the above limitation or exclusion may not apply to you.

This warranty gives you specific legal rights, and you may also have other rights which vary from state to state.

This warranty applies to all ECHO brand 56 Volt outdoor products manufactured by or for ECHO Incorporated, and sold in the United States and Canada.

To locate your nearest authorized ECHO dealer, visit www.ECHO-usa.com or dial 1-800-432-ECHO (3246).

PRODUCT REGISTRATION

Thank you for choosing ECHO Power Equipment

Please go to <http://www.echo-usa.com/Warranty/Register-Your-ECHO> to register your new product on-line. It's FAST and EASY! NOTE: your information will never be sold or misused by ECHO, Incorporated.

Registering your purchase enables us to contact you in the unlikely event of a service update or product recall, and verifies your ownership for warranty consideration.

If you do not have access to the Internet, you can complete the form below and mail to:

ECHO Incorporated, Product Registration, PO Box 1139, Lake Zurich, IL 60047.



PRODUCT REGISTRATION CARD : TARJETA DE REGISTRO : CARTE D'ENREGISTREMENT DU PRODUIT

ONLINE OPTION: Register online and save a stamp! You will be alerted of product updates and/or be sent new ECHO product information and special offers. Simply go to: www.echo-usa.com

OPCIÓN POR INTERNET: Regístrese en la página web y ahorre un sello. Usted será alertado de actualizaciones de productos ECHO y las ofertas especiales. Simplemente visite: www.echo-usa.com

OPTION EN LIGNE: Enregistrer en ligne et épargner un timbre! Vous serez informé sur les nouveaux produits ECHO et les offres spéciales. Simplemente visitez: www.echo-usa.com

Please Print : Por Favor Escribe Con Letra De Moldé : En Lettre Carré S.V.P.

Confidential: Information provided will not be shared or sold

Purchaser's Name : Nombre del Comprador : Nom de l'acheteur	
Address : Dirección : Adresse	
City : Ciudad : Ville	State : Estado : Zip Code : Código Postal : Code Postal / Province
E-Mail Address : Dirección De Correo Electrónico : Courrier Electronique	
Phone Number : Número De Teléfono : Téléphone	Date of Purchase : Fecha de la Compra : Date de l'achat
Where Purchased : Nombre del Almacén donde fue Comprado : Lieu d'achat	
Model Number : Número del Modelo : No. de modelo	Serial Number : Número de Serie : No. de série

Registering your purchase enables us to contact you in the unlikely event of a service update or product recall and verifies your ownership in the event of loss. El registrar su compra nos permite estar en contacto con usted en caso de cualquier evento de actualización de servicio o llamado de atención de un producto. El enregistrement de votre achat nous permettra de vous contacter dans le cas improbable de modifications des instructions d'entretien ou de rappel du produit et vérifier que vous êtes le propriétaire en cas de vol ou de perte.

Primary use of tool: Professional Homeowner Rental Equip.
 Uso primario de la herramienta: Profesional Dueño de casa Alquiler
 Usage principal: Profesional Residential Location
 Do you wish to receive periodic ECHO product information and special offers by e-mail? Yes No
 ¿Desea usted recibir información periódica y ofertas especiales por correo electrónico sobre el producto ECHO? Yes No
 Souhaitez-vous recevoir périodiquement de l'information sur les produits ECHO et les offres spéciales par courrier électronique? Oui Non
 Did you visit the ECHO website before purchasing your product?
 Yes No
 Visitéz usted la página web ECHO antes de comprar su producto?
 Si No
 Avez-vous visité le site d'ECHO avant de procurer votre produit?
 Oui Non

What factor(s) most influenced your purchase?
 Performance Dealer
 Reliability Price
 Friend/Family Prior Experience Quality
 Warranty
 ¿Qué factor(es) influyó más en su compra?
 Funcionamiento Precio Distribuidor
 Confiablez Calidad Experiencia Anterior
 Amigo/Familia Marca Garantía

Quel facteur (facteurs) vous a influencé le plus?
 Performance Prix Marchand
 Fiabilité Expérience Qualité
 Ami/Famille Marque Garantie

ECHO INC., 400 Oakwood Rd., Lake Zurich, IL 60047
 1.800.432.ECHO WWW.ECHO-USA.COM

X7572270206 02-2012



NOTES

409BPH100001 - 409BPH999999

402BPH100001 - 402BPH999999



ECHO INCORPORATED

400 Oakwood Road

Lake Zurich, IL 60047

www.echo-usa.com