



HC-152

Hedge Clipper

Operator's Manual

WARNING

Burn Hazard



The muffler or catalytic muffler and surrounding cover may become extremely hot. Always keep clear of exhaust and muffler area, otherwise serious personal injury may occur.

WARNING

The engine exhaust from this product contains chemicals known to the State of California to cause cancer, birth defects or other reproductive harm.

WARNING



Users of this equipment risk injury to themselves and others if the unit is used improperly and/or safety precautions are not followed. ECHO provides an operator's manual and a safety manual. Both must be read and understood for proper and safe operation. Failure to do so could result in serious injury.

Specifications, descriptions and illustrative material in this literature are as accurate as known at the time of publication, but are subject to change without notice. Illustrations may include optional equipment and accessories, and may not include all standard equipment.

TABLE OF CONTENTS

Table of contents 2

Introduction 3

 The Operator’s Manual 3

 The Safety Manual..... 3

Servicing information 3

 Parts/Serial Number..... 3

 Service 3

 Echo Consumer Product Support 3

 Warranty Registration 3

 Additional or Replacement Manuals 4

Safety..... 4

 Manual Safety Symbols and Important Information 4

 International Symbols 5

 Personal Condition and Safety Equipment 5

 Equipment..... 8

Emission Control (Exhaust & Evaporative)..... 9

 EPA 2010 and Later and/or C.A.R.B. TIER III 9

Description 10

Contents 12

Assembly 13

 Remove Blade Guard 13

 Install Blade Guard 13

Operation 15

 Fuel 15

 Starting Cold Engine 16

 Starting Warm Engine..... 18

 Stopping Engine..... 18

 Hedge Trimming 19

Maintenance 20

 Skill Levels 20

 Maintenance Intervals..... 20

 Air Filter..... 21

 Fuel Filter 21

 Spark Plug 22

 Cooling System..... 22

 Exhaust System..... 23

 Carburetor Adjustment..... 24

 Lubrication 25

 Blades 26

Troubleshooting 28

Storage 29

 Long Term Storage (Over 30 Days)..... 29

Specifications..... 30

Warranty Statements 31

Notes 33

INTRODUCTION

Welcome to the ECHO family. This ECHO product was designed and manufactured to provide long life and on-the-job dependability. Read and understand this manual and the SAFETY MANUAL. You will find both easy to use and full of helpful operating tips and SAFETY messages.

The Operator's Manual

Keep it in a safe place for future reference. Contains specifications and information for safety, operation, maintenance, storage and assembly specific to this product.

The Safety Manual

Keep it in a safe place for future reference. Explains possible hazards and the measures you should take to insure safe operation.

SERVICING INFORMATION

Parts/Serial Number

Genuine ECHO Parts and ECHO REPOWER™ Parts and Assemblies for your ECHO products are available only from an Authorized ECHO Dealer. When you do need to buy parts **always** have the Model Number and Serial Number of the unit with you. You can find these numbers on the engine housing. For future reference, write them in the space provided below.

Model No. _____ SN. _____

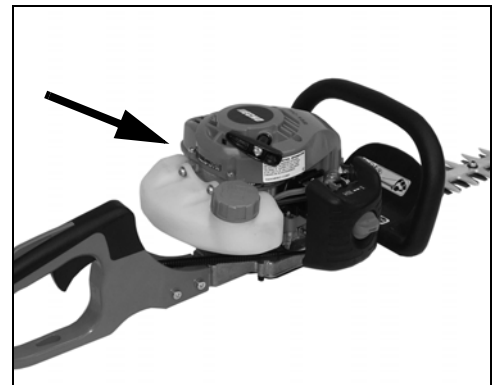

Service

Service of this product during the warranty period must be performed by an Authorized ECHO Service Dealer. For the name and address of the Authorized ECHO Service Dealer nearest you, ask your retailer or call: 1-800-432-ECHO (3246). Dealer information is also available on our Web Site. When presenting your unit for Warranty service/repairs, proof of purchase is required.

Echo Consumer Product Support

If you require assistance or have questions concerning the application, operation or maintenance of this product you may call the ECHO Consumer Product Support Department at 1-800-673-1558 from 8:30 am to 4:30 pm (Central Standard Time) Monday through Friday. Before calling, please know the model and serial number of your unit.

Warranty Registration

To ensure trouble free warranty coverage it is important that you register your ECHO equipment on-line at www.echo-usa.com or by filling out the warranty registration card supplied with your unit. Registering your product confirms your warranty coverage and provides a direct link between you and ECHO if we find it necessary to contact you.

Additional or Replacement Manuals

Replacement Operator, Safety Manuals, and Parts Catalogs are available from your ECHO dealer or at www.echo-usa.com or by contacting ECHO Inc., 400 Oakwood Road, Lake Zurich, IL 60047 (800-673-1558). Always check the ECHO Web Site for updated information.

Safety Videos are available from your Echo dealer. A \$5.00 shipping charge will be required for each video.

SAFETY

Manual Safety Symbols and Important Information

Throughout this manual and on the product itself, you will find safety alerts and helpful, informational messages preceded by symbols or key words. The following is an explanation of those symbols and key words and what they mean to you.

DANGER

The safety alert symbol accompanied by the word “DANGER” calls attention to an act or condition which WILL lead to serious personal injury or death if not avoided.

WARNING

The safety alert symbol accompanied by the word “WARNING” calls attention to an act or condition which CAN lead to serious personal injury or death if not avoided.

CAUTION

The safety alert symbol accompanied by the word “CAUTION” calls attention to an act or condition which may lead to minor or moderate personal injury if not avoided.

NOTICE

The enclosed message provides information necessary for the protection of the unit.

Note: This enclosed message provides tips for use, care and maintenance of the unit.



CIRCLE AND SLASH SYMBOL

This symbol means the specific action shown is prohibited. Ignoring these prohibitions can result in serious or fatal injury.

International Symbols

Symbol	Description	Symbol	Description	Symbol	Description	Symbol	Description
	Read and understand owners manual.		Fuel and oil mixture	L	Carburetor Adjustment - Low speed mixture	H	Carburetor Adjustment - High speed mixture
	Wear eye, ear and head protection		Finger severing		Safety/Alert	T	Carburetor Adjustment - Idle speed
	Emergency Stop		Hot Surface		Avoid all power lines. This unit is not insulated against electrical current.		Do not operate closer than 15 M (50 ft.) from electrical hazard.
	Wear hand and foot protection. Use two handed		DO NOT smoke near fuel		Plan retreat path from falling objects		Primer Bulb
	Choke Control "Cold Start" Position (Choke Closed)		Ignition ON / OFF		DO NOT allow flames or sparks near fuel		Wear slip resistant footwear
	Choke Control "Run" Position (Choke Open)		Do not operate without guards in place.			Keep bystanders at least 4.5 meters (15 ft.) away.	

Personal Condition and Safety Equipment

WARNING

Users of this product risk injury to themselves and others if the unit is used improperly and/or safety precautions are not followed. Proper clothing and safety gear must be worn when operating unit.

Physical Condition

Your judgment and physical dexterity may not be good:

- if you are tired or sick,
- if you are taking medication,
- if you have taken alcohol or drugs.

Operate unit only if you are physically and mentally well.

Eye Protection

Eye protection that meets ANSI Z87.1 or CE requirements must be worn whenever you operate the unit.

Hand Protection

Wear no-slip, heavy duty work gloves to improve your grip on the handles. Gloves also reduce the transmission of machine vibration to your hands.

Breathing Protection

Wear a facemask to protect against dust.

Hearing Protection

ECHO recommends wearing hearing protection whenever unit is used.

Proper Clothing

Wear snug fitting, durable clothing;

- Pants should have long legs, shirts with long sleeves.
- DO NOT WEAR SHORTS,
- DO NOT WEAR TIES, SCARVES, JEWELRY, or clothing with loose or hanging items that could become entangled in moving parts or surrounding growth.

Wear sturdy work shoes with nonskid soles;

- DO NOT WEAR OPEN TOED SHOES,
- DO NOT OPERATE UNIT BAREFOOTED.

Wear no-slip, heavy duty work gloves.

Keep long hair away from engine and air intake. Retain hair with cap or net.

Hot Humid Weather

Heavy protective clothing can increase operator fatigue which may lead to heat stroke. Schedule heavy work for early morning or late afternoon hours when temperatures are cooler.

WARNING

The ignition components of this machine generate an electromagnetic field during operation which may interfere with some pacemakers. To reduce the risk of serious or fatal injury, persons with pacemakers should consult with their physician and the pacemaker manufacturer before operating this machine. In the absence of such information, ECHO does not recommend the use of ECHO products by anyone who has a pacemaker.

Vibration and Cold

It is believed that a condition called Raynaud's Phenomenon, which affects the fingers of certain individuals, may be brought about by exposure to vibration and cold. Exposure to vibration and cold may cause tingling and burning sensations, followed by loss of color and numbness in the fingers. The following precautions are strongly recommended, because the minimum exposure, which might trigger the ailment, is unknown.

- Keep your body warm, especially the head, neck, feet, ankles, hands, and wrists.
- Maintain good blood circulation by performing vigorous arm exercises during frequent work breaks, and also by not smoking.
- Limit the hours of operation. Try to fill each day with jobs where operating the unit or other hand-held power equipment is not required.
- If you experience discomfort, redness, and swelling of the fingers followed by whitening and loss of feeling, consult your physician before further exposing yourself to cold and vibration.



Repetitive Stress Injuries

It is believed that overusing the muscles and tendons of the fingers, hands, arms, and shoulders may cause soreness, swelling, numbness, weakness, and extreme pain in those areas. Certain repetitive hand activities may put you at a high risk for developing a Repetitive Stress Injury (RSI). An extreme RSI condition is Carpal Tunnel Syndrome (CTS), which could occur when your wrist swells and squeezes a vital nerve that runs through the area. Some believe that prolonged exposure to vibration may contribute to CTS. CTS can cause severe pain for months or even years.

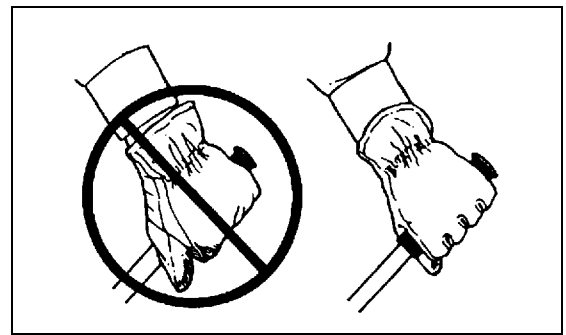

To reduce the risk of RSI/CTS, do the following:

- Avoid using your wrist in a bent, extended, or twisted position. Instead try to maintain a straight wrist position. Also, when grasping, use your whole hand, not just the thumb and index finger.
- Take periodic breaks to minimize repetition and rest your hands.
- Reduce the speed and force with which you do the repetitive movement.
- Do exercise to strengthen the hand and arm muscles.
- Immediately stop using all power equipment and consult a doctor if you feel tingling, numbness, or pain in the fingers, hands, wrists, or arms. The sooner RSI/CTS is diagnosed, the more likely permanent nerve and muscle damage can be prevented.

DANGER

Do not operate this product indoors or in inadequately ventilated areas. Engine exhaust contains poisonous emissions and can cause serious injury or death.

Read the Manuals

- Provide all users of this equipment with the Operator’s Manual and Safety Manual for instructions on Safe Operation.

Clear the Work Area

- Spectators and fellow workers must be warned, and children and animals prevented from coming nearer than 15 m (50 ft.) while the unit is in use.

Keep a Firm Grip

- Hold the front and rear handles with thumbs and fingers encircling the grips.

Keep a Solid Stance

- Maintain footing and balance at all times. Do not stand on slippery, uneven or unstable surfaces. Do not work in odd positions or on ladders. Do not over reach.

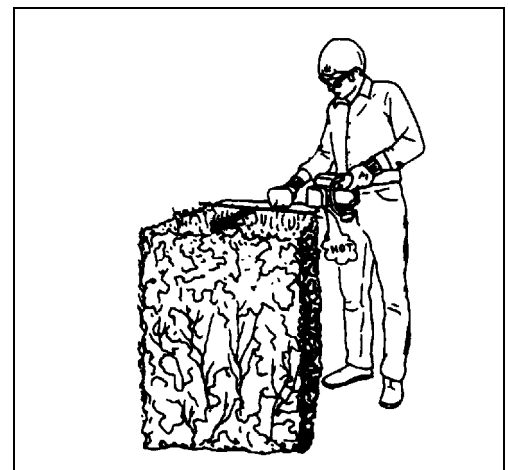

Avoid Hot Surfaces

- Keep exhaust area clear of flammable debris. Avoid contact during and immediately after operation.

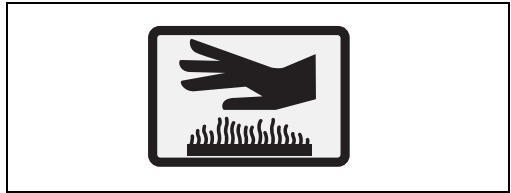

WARNING

Never perform blade maintenance procedures while engine is running.

Equipment

WARNING

Use only ECHO approved attachments. Serious injury may result from the use of a non-approved attachment combination. ECHO, INC. will not be responsible for the failure of cutting devices, attachments or accessories which have not been tested and approved by ECHO. Read and comply with all safety instructions listed in this manual and safety manual.

- Check unit for loose/missing nuts, bolts, and screws. Tighten and/or replace as needed.
- Check that the cutting attachment is firmly attached and in safe operating condition. Dull, loose or damaged blades should not be used.

WARNING

Moving parts can amputate fingers or cause severe injuries. Keep hands, clothing and loose objects away from all openings.

- *ALWAYS stop engine, disconnect spark plug, and make sure all moving parts have come to a complete stop before removing obstructions, clearing debris, or servicing unit.*
- *DO NOT start or operate unit unless all guards and protective covers are properly assembled to unit.*
- *NEVER reach into any opening while the engine is running. Moving parts may not be visible through openings.*

WARNING

Check fuel system for leaks due to fuel tank damage, especially if the unit is dropped. If damage or leaks are found, do not use unit, otherwise serious personal injury or property damage may occur. Have unit repaired by an authorized servicing dealer before using.

EMISSION CONTROL (EXHAUST & EVAPORATIVE)

EPA 2010 and Later and/or C.A.R.B. TIER III

The emission control system for the engine is EM (engine modification) and, if the second to last character of the Engine Family on the Emission Control Information label (sample below) is “C”, “K”, or “T”, the emission control system is EM and TWC (3-way catalyst). The fuel tank/fuel line emission control system is EVAP (evaporative emissions). Evaporative emissions for California models are only applicable to fuel tanks.

An Emission Control Label is located on the engine. (This is an EXAMPLE ONLY, information on label varies by engine FAMILY).

Product Emission Durability (Emission Compliance Period)

The 50 or 300 hour emission compliance period is the time span selected by the manufacturer certifying the engine emissions output meets applicable emissions regulations, provided that approved maintenance procedures are followed as listed in the Maintenance Section of this manual.



DESCRIPTION

Locate the safety decal(s) on your unit. Make sure the decal(s) is legible and that you understand and follow the instructions on it. If a decal cannot be read, a new one can be ordered from your ECHO dealer. See PARTS ORDERING instructions for specific information.

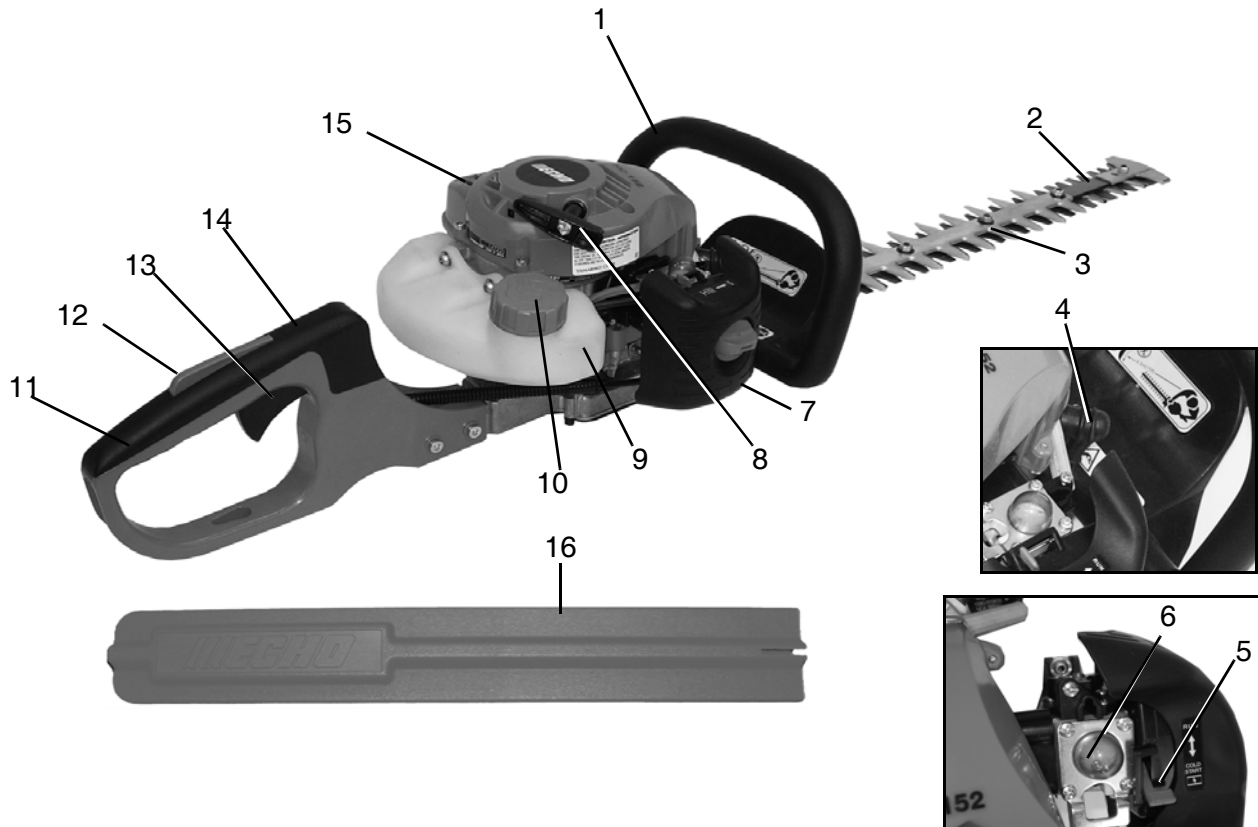

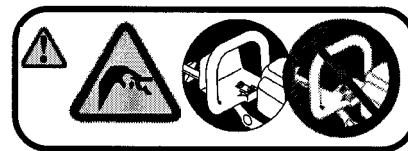
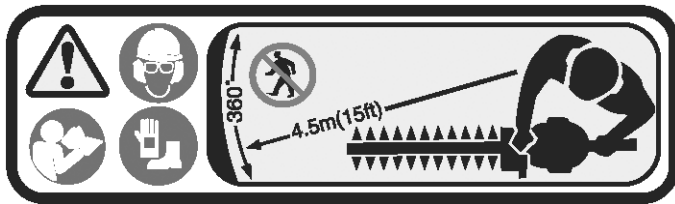

Right Front Handle Guard



Hot Decal (near muffler)



1. **FRONT HANDLE WITH GUARD** - Comfortable, textured finish provides anti-slip grip. Guard protects hand from the blades. Warning decals are located on guard
2. **BLADES** - Double reciprocating blades mounted to a blade support bar. The blades are double sided, capable of cutting on either side.
3. **BLADE GUARD**- Reduces risk of contact with blades and helps guide material into cutters
4. **SPARK PLUG** - Provides spark to ignite fuel mixture.
5. **CHOKE** - The choke control lever is located on the front of the air cleaner case. Move choke lever to "COLD START" () to close the choke for Cold Starting. Move choke lever to "RUN" () position to open choke.
6. **PURGE BULB** - Pumping purge bulb before starting engine draws fresh fuel from the fuel tank, purging air from the carburetor. Pump purge bulb until fuel is visible and flows freely in the clear fuel tank return line. Pump purge bulb an additional 4 or 5 times.
7. **AIR CLEANER** - Contains replaceable filter element.
8. **RECOIL STARTER HANDLE** - Pull handle slowly until recoil starter engages, then quickly and firmly. DO NOT pull rope all the way out or allow the handle to snap back, damage to the starter will occur.
9. **FUEL TANK** - Contains fuel and fuel filter.
10. **FUEL TANK CAP** - Covers and seals fuel tank opening.
11. **REAR HANDLE** - Contains Stop Switch, Throttle Lockout and Throttle Trigger.
12. **THROTTLE TRIGGER LOCKOUT** - This lever must be depressed before Throttle Trigger can be activated.
13. **THROTTLE TRIGGER** - Spring loaded to return to idle when released. Trigger Lockout must be depressed fully before Throttle Trigger will move. During acceleration, depress gradually for best operating technique.
14. **STOP SWITCH** - "TOGGLE SWITCH" located on the left side of the rear handle. Move switch UP to RUN, DOWN to STOP.
15. **SPARK ARRESTOR MUFFLER OR SPARK ARRESTOR MUFFLER WITH CATALYST** -The muffler controls exhaust noise and emission. The spark arrestor screen prevents hot, glowing particles of carbon from leaving the muffler. Keep exhaust area clear of flammable debris.
16. **BLADE COVER** - Used to cover blades during transportation or storage. Remove blade cover before using unit.

CONTENTS

After opening the carton, check for damage. Immediately notify your retailer or ECHO Dealer of damaged or missing parts. Use the contents list to check for missing parts.

- ____ 1 - Hedge Clipper Assembly
- ____ 1 - Operator's Manual
- ____ 1 - Safety Manual
- ____ 1 - Emission Control Warranty Statement
- ____ 1 - Warranty Registration Card
- ____ 1 - Echo Power Blend X™ 2-Stroke Oil Sample
- ____ 1 - Blade Cover

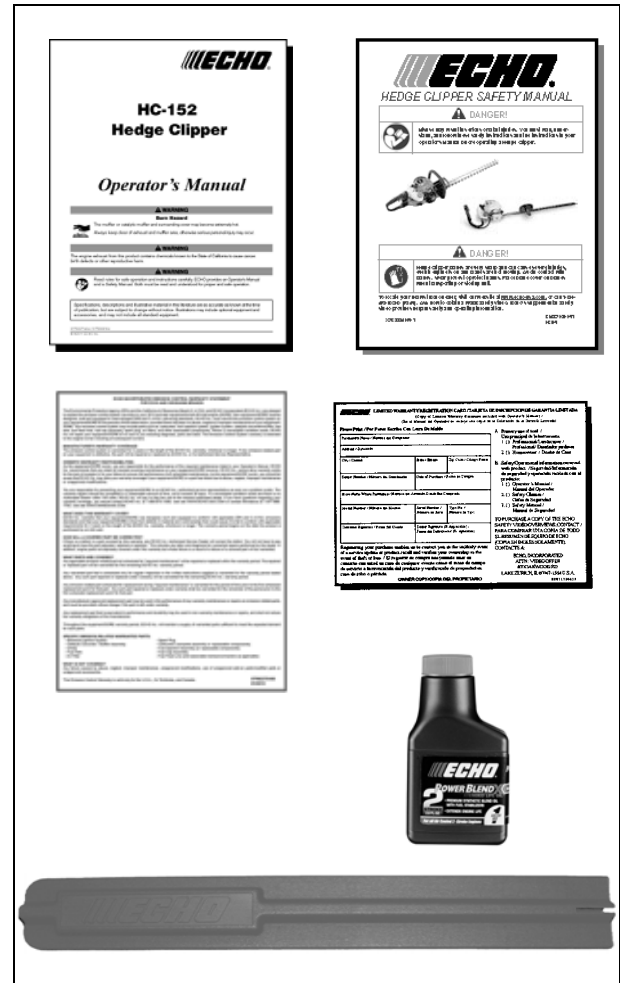

ASSEMBLY

This model is factory assembled.

Note: For Normal cutting, Echo strongly recommends the blade guard be installed. In extreme conditions, such as commercial cutting or when cutting thick and/or dense branches, efficiency may be increased by trimming without the blade guard.

Parts Required: Blade Guard, Blade Lock Nuts (P/N 43302206460), Washers

⚠ WARNING

Hedge Clipper blades are very sharp. Touching them may lead to severe personal injury. Avoid touching blades whenever possible, and always wear gloves to protect hands.

NOTICE

Follow blade bolt adjustment instructions exactly. Failure to do so could result in damage to blades or gearbox.

Remove Blade Guard

1. Move stop switch to stop position
2. Disconnect spark plug wire.

⚠ WARNING

Hedge clipper blades are very sharp. Touching them may lead to severe personal injury. Use a socket and extension when adjusting blade bolts or blade locknuts in order to keep hands at a safe distance from sharp blades.

3. Remove blade guard locknuts (A) and washers. Do not remove blade bolts.
4. Remove blade guard
5. Tighten blade bolts (B) until snug, then loosen ½ turn.
6. Secure blades with new locknuts (A). Hold blade bolts from turning using a 10mm wrench.

Note: Use new locknuts every time blade guard is installed or removed.

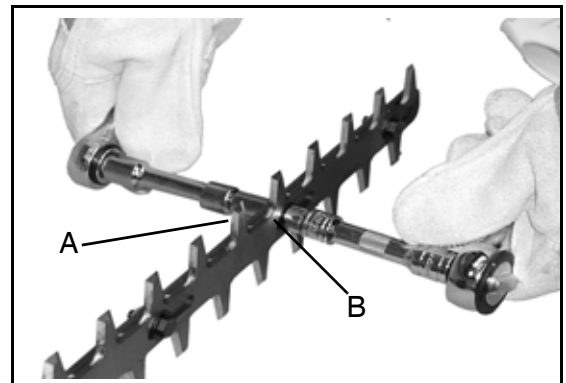

Install Blade Guard

1. Move stop switch to stop position
2. Disconnect spark plug wire.

⚠ WARNING

Hedge clipper blades are very sharp. Touching them may lead to severe personal injury. Use a socket and extension when adjusting blade bolts or blade locknuts in order to keep hands at a safe distance from sharp blades.

3. Lay unit on muffler side and hold securely in place.

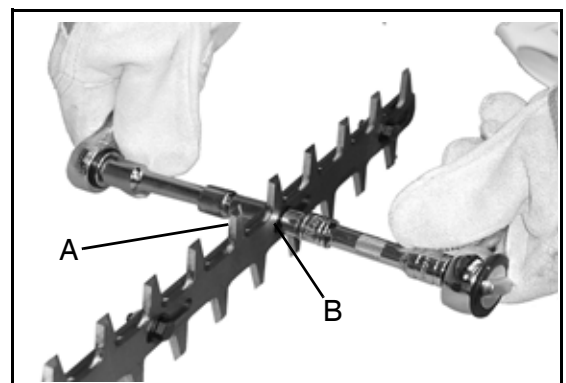

4. Remove first four blade locknuts (A) and washers in front of front handle/guard. Do not remove blade bolts.
5. Tighten blade bolts (B) until snug. Install blade guard, then washers
6. Loosen blade bolts $\frac{1}{2}$ turn. Secure blade guard with new locknuts (A). Hold blade bolts from turning using a 10mm wrench. Use new locknuts every time blade guard is installed or removed.

Note: Use new locknuts every time blade guard is installed or removed

NOTICE

If blade guard is damaged or show signs of wear, replace it.

Note: Washers (C) should be movable by hand after blade bolts are adjusted properly.

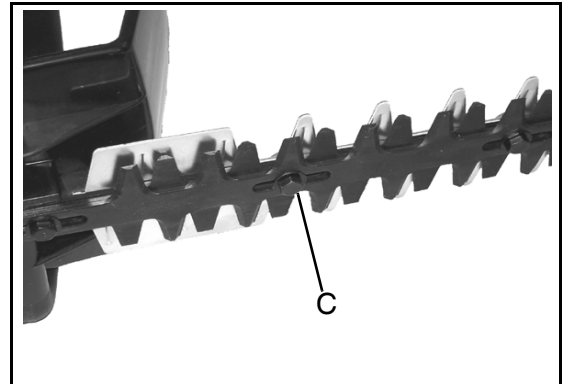

OPERATION

WARNING

Moving parts can amputate fingers or cause severe injuries. Keep hands, clothing and loose objects away from all openings. Always stop engine, disconnect spark plug, and make sure all moving parts have come to a complete stop before removing obstructions, clearing debris, or servicing unit.

WARNING

Operation of this equipment may create sparks that can start fires. This unit is equipped with a spark arrestor to prevent discharge of hot particles from the engine. Metal cutters can create sparks if the cutter strikes rocks, metal, or other hard objects. Contact local fire authorities for laws or regulations regarding fire prevention requirements.

Fuel

WARNING

Alternative fuels, such as E-15 (15% ethanol), E-85 (85% ethanol) or any fuels not meeting ECHO requirements are NOT approved for use in ECHO 2-stroke gasoline engines. Use of alternative fuels may cause performance problems, loss of power, overheating, fuel vapor lock, and unintended machine operation, including, but not limited to, improper clutch engagement. Alternative fuels may also cause premature deterioration of fuel lines, gaskets, carburetors and other engine components.

Fuel Requirements

Gasoline - Use 89 Octane [R+M/2] (mid grade or higher) gasoline known to be good quality. Gasoline may contain up to 10% Ethanol (grain alcohol) or 15% MTBE (methyl tertiary-butyl ether). Gasoline containing methanol (wood alcohol) is **NOT** approved.

Two Stroke Oil - A two-stroke engine oil meeting ISO-L-EGD (ISO/CD 13738) and J.A.S.O. FD Standards must be used. Echo brand premium Power Blend X™ Universal 2-Stroke Oil meets these standards. Engine problems due to inadequate lubrication caused by failure to use an ISO-L-EGD (ISO/CD 13738) and J.A.S.O. FD certified oil, such as Echo premium Power Blend X™, will void the two-stroke engine warranty.

NOTICE

Echo premium Power Blend X™ Universal 2-Stroke Oil may be mixed at 50:1 ratio for application in all Echo engines sold in the past regardless of ratio specified in those manuals.

Handling Fuel

DANGER

Fuel is VERY flammable. Use extreme care when mixing, storing or handling, or serious personal injury may result.

- *Use an approved fuel container.*
- *DO NOT smoke near fuel.*
- *DO NOT allow flames or sparks near fuel.*
- *Fuel tanks/cans may be under pressure. Always loosen fuel caps slowly allowing pressure to equalize.*

- **NEVER refuel a unit when the engine is HOT or RUNNING!**
- **DO NOT fill fuel tanks indoors. ALWAYS fill fuel tanks outdoors over bare ground.**
- **DO NOT overfill fuel tank. Wipe up spills immediately.**
- **Securely tighten fuel tank cap and close fuel container after refueling.**
- **Inspect for fuel leakage. If fuel leakage is found, do not start or operate unit until leakage is repaired.**
- **Move at least 3m (10 ft.) from refueling location before starting the engine.**

Mixing Instructions

1. Fill an approved fuel container with half of the required amount of gasoline.
2. Add the proper amount of 2-stroke oil to gasoline.
3. Close container and shake to mix oil with gasoline.
4. Add remaining gasoline, close fuel container, and remix.

Fuel to Oil Mix - 50:1 Ratio			
U.S.		METRIC	
GAS	OIL	GAS	OIL
Gallons	Fl. oz.	Liter	cc.
1	2.6	4	80
2	5.2	8	160
5	13	20	400

NOTICE

Spilled fuel is a leading cause of hydrocarbon emissions. Some states may require the use of automatic fuel shut-off containers to reduce fuel spillage.

After use

- DO NOT store a unit with fuel in its tank. Leaks can occur. Return unused fuel to an approved fuel storage container.

Storage - Fuel storage laws vary by locality. Contact your local government for the laws affecting your area. As a precaution, store fuel in an approved, airtight container. Store in a well-ventilated, unoccupied building, away from sparks and flames.

NOTICE

Stored fuel ages. Do not mix more fuel than you expect to use in thirty (30) days, ninety (90) days when a fuel stabilizer is added.

NOTICE

Stored two-stroke fuel may separate. ALWAYS shake fuel container thoroughly before each use.

Starting Cold Engine

⚠ WARNING

Hedge Clipper blades are very sharp. Touching them may lead to severe personal injury. Avoid touching blades whenever possible, and always wear gloves to protect hands.

Note: The blade cover is used for transportation and storage. Remove blade cover before using the unit.

1. Stop Switch

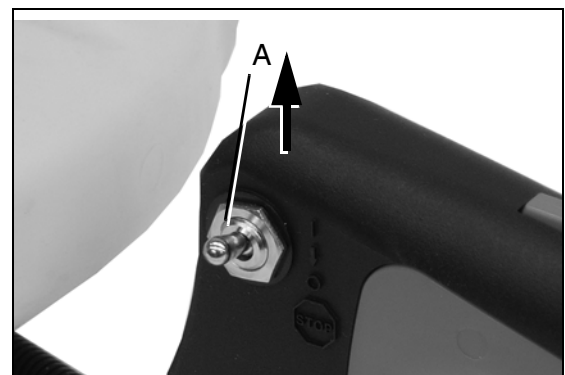

Move stop switch (A) away from the STOP position.

2. *Choke*

Move choke (B) to Cold Start () (closed) position.

3. *Purge Bulb*

Pump purge bulb (C) until fuel is visible and flows freely in the clear fuel tank return line. Pump bulb an additional 4 or 5 times.

4. *Recoil Starter*

Lay the unit on a flat, clear area. Grip the front handle securely with one hand, and pull the recoil starter handle (D) until engine fires (or 5 pulls maximum).

5. *Choke*

After engine fires (or 5 pulls), move choke (B) to the Run () (open) position. Restart engine if necessary and allow unit to warm up at idle for several minutes.

Note: If engine does not start with choke in “Run” position after 5 pulls, repeat instructions 2 - 5.

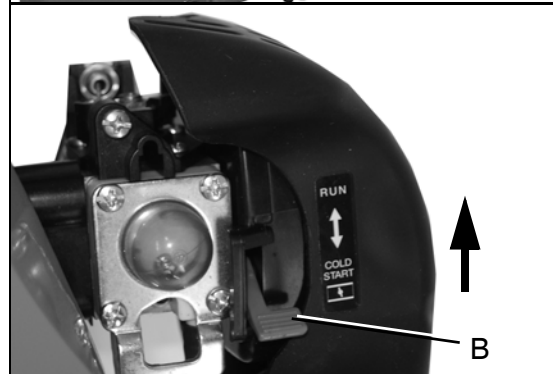
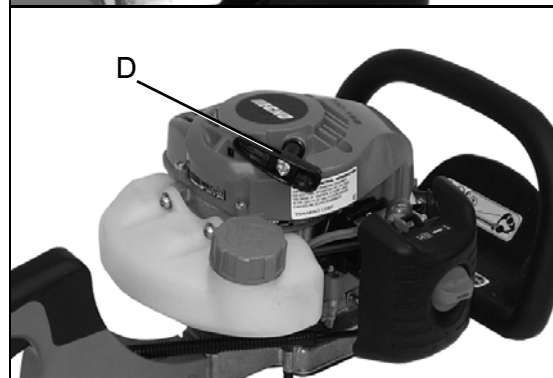
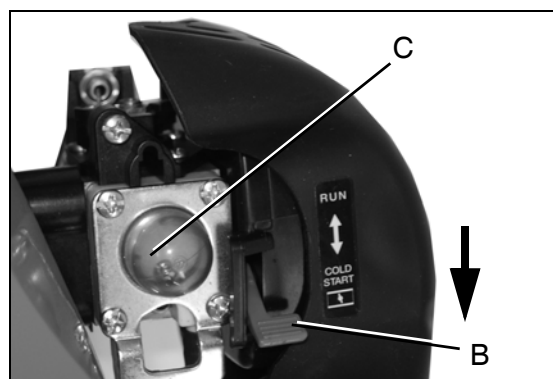

⚠ WARNING

The blades must not move at idle, otherwise serious personal injury may result. Periodic carburetor adjustment may be necessary to assure blades do not move at idle. If blades move, readjust carburetor according to “Carburetor Adjustment” instructions in this manual or see your ECHO Dealer.

6. *Throttle Trigger*

After engine warm-up, grip the rear handle and front handle. Depress the throttle trigger lockout, and gradually depress throttle trigger to increase engine RPM to operating speed.

Starting Warm Engine

The starting procedure is the same as Cold Start except DO NOT close the choke.

⚠ WARNING

The blades must not move at idle, otherwise serious personal injury may result. Periodic carburetor adjustment may be necessary to assure blades do not move at idle. If blades move, readjust carburetor according to "Carburetor Adjustment" instructions in this manual or see your ECHO Dealer.

1. Stop Switch

Move stop switch (A) away from the STOP position.

2. Purge Bulb

Pump purge bulb (C) until fuel is visible and flows freely in the clear fuel tank return line. Pump bulb an additional 4 or 5 times.

3. Recoil Starter

Place the unit on a flat, clear area. Grip the front handle securely with one hand, and pull the recoil starter handle (D) until engine starts.

Note: If engine does not start after 5 pulls, use Cold Start Procedure.

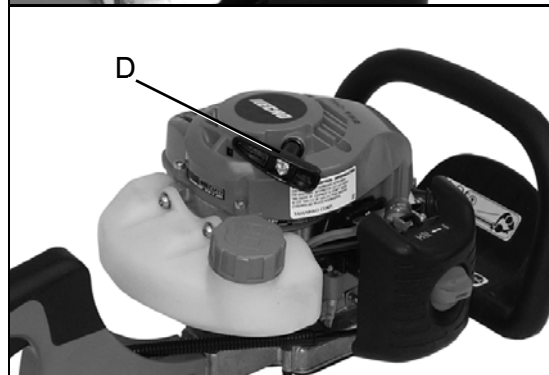
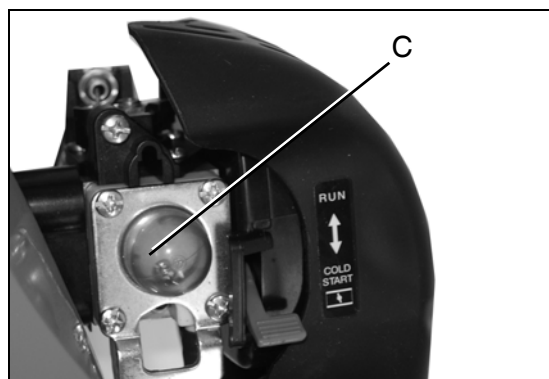
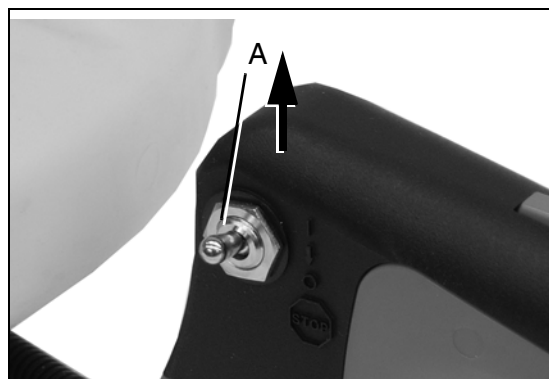

Stopping Engine

1. Throttle

Release throttle and allow engine to return to idle before shutting off engine.

2. Stop Switch

Move stop switch (A) to STOP position.

⚠ WARNING

If engine does not stop when stop switch is moved to STOP position, close choke - COLD START position - to stall engine. Have your ECHO dealer repair stop switch before using trimmer again.

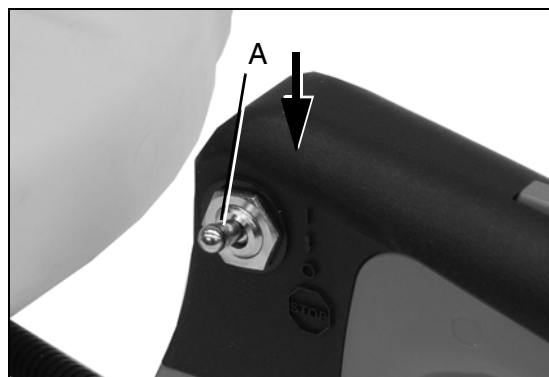

Hedge Trimming

⚠ WARNING

Engine exhaust IS HOT, and contains Carbon Monoxide (CO), a poison gas. Breathing CO can cause unconsciousness, serious injury, or death. Exhaust can cause serious burns. ALWAYS position unit so that exhaust is directed away from your face and body.

⚠ WARNING

Hedge Clipper blades are very sharp. Touching them may lead to severe personal injury. Avoid touching blades whenever possible, and always wear gloves to protect hands.

1. Always grip front and rear handles.
2. Hold trimmer firmly and squeeze throttle trigger to accelerate engine.
3. Tilt trimmer so cutting teeth are angled slightly toward the hedge or shrub and proceed to cut.

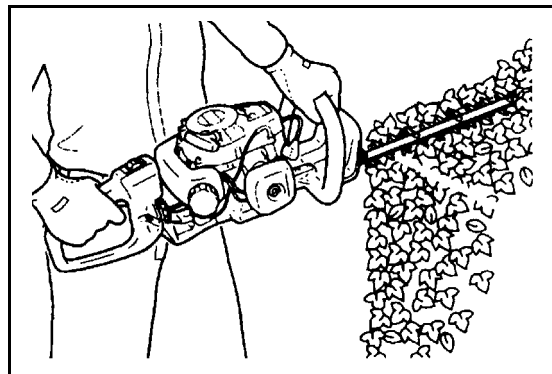

⚠ WARNING

Never remove hands from unit when blades are moving.

⚠ WARNING

The engine continues running even when the blades have stopped due to an obstruction. If this occurs, stop the engine, disconnect ignition cable and remove the obstruction

MAINTENANCE

⚠ WARNING

Moving parts can amputate fingers or cause severe injuries. Keep hands, clothing and loose objects away from all openings. Always stop engine, disconnect spark plug, and make sure all moving parts have come to a complete stop before removing obstructions, clearing debris, or servicing unit. Allow unit to cool before performing service. Wear gloves to protect hands from sharp edges and hot surfaces.

Your ECHO unit is designed to provide many hours of trouble free service. Regular scheduled maintenance will help your unit achieve that goal. If you are unsure or are not equipped with the necessary tools, you may want to take your unit to an ECHO Service Dealer for maintenance. To help you decide whether you want to DO-IT-YOURSELF or have the ECHO Dealer do it, each maintenance task has been graded. If the task is not listed, see your ECHO Dealer for repairs.

Skill Levels

Level 1 = Easy to do. Common tools may be required.

Level 2 = Moderate difficulty. Some specialized tools may be required.

ECHO offers **REPOWER™** Maintenance Kits and Parts to make your maintenance job easier.

Maintenance Intervals

COMPONENT/SYSTEM	MAINTENANCE PROCEDURE	REQ'D SKILL LEVEL	DAILY OR BEFORE USE	EVERY REFUEL	3 MONTHS	YEARLY
Air Filter	Inspect/Clean	1	I / C *		R *	
Choke Shutter	Inspect/Clean	1	I / C			
Fuel Filter	Inspect/Replace	1			I *	I / R *
Fuel Cap Gasket	Inspect/Replace	1			I *	R *
Fuel System	Inspect/Replace	1	I (3) *	I (3) *		
Spark Plug	Inspect/Clean/Replace	1			I / C / R *	
Cooling System	Inspect/Clean	2	I / C			
Muffler Spark Arrestor	Inspect/Clean/Replace	2			I / C / R *	
Cylinder Exhaust Port	Inspect/Clean/Decarbon	2			I / C	
Gear Housing	Grease	2			I (1)	
Blades	Inspect/Clean	1	I / C (2)			
Recoil Starter Rope	Inspect/Clean	1	I / C *			
Screws/Nuts/Bolts	Inspect/Tighten/Replace	1	I *			

MAINTENANCE PROCEDURE LETTER CODES: I = INSPECT, R = REPLACE, C = CLEAN

IMPORTANT NOTE - Time intervals shown are maximum. Actual use and your experience will determine the frequency of required maintenance.

MAINTENANCE PROCEDURE NOTES: (1) Apply POWER BLENDX™ grease every 25 hours of use.

(2) Inspect blade, and clean and sharpen as needed. Lubricate blades periodically during use.

(3) Low evaporative fuel tanks DO NOT require regular maintenance to maintain emission integrity.

* Replacement is recommended based on the finding of damage or wear during inspection.

Air Filter

Level 1.

Parts Required: REPOWER™ AIR & FUEL FILTER KIT.

1. Close choke (Cold Start Position []). This prevents dirt from entering the carburetor throat when the air filter is removed. Brush accumulated dirt from air cleaner area.
2. Remove air filter cover. Brush dirt from inside cover.
3. Replace filter if it is damaged, fuel soaked, very dirty, or the rubber sealing edges are deformed.
 - Lightly brush debris from filter.
 - Soak heavily soiled filters in water/detergent solution to loosen dirt, then brush lightly.
 - Rinse with clean water and allow to dry completely before reuse.
4. Install air filter in air filter case.
5. Install air filter cover.

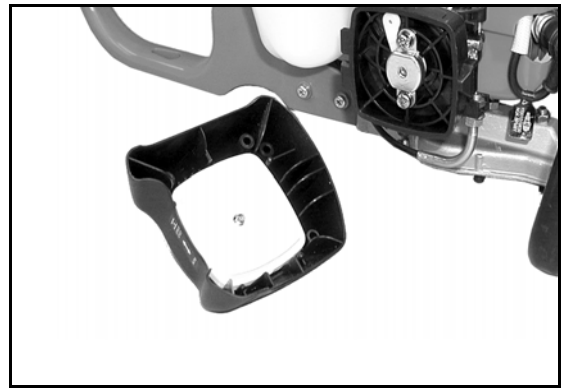

Fuel Filter

Level 1.

Parts Required: REPOWER™ AIR & FUEL FILTER KIT.

 DANGER

Fuel is VERY flammable. Use extreme care when mixing, storing or handling, or serious personal injury may result.

1. Use a clean rag to remove loose dirt from around fuel cap and empty fuel tank.
2. Use the “fuel line hook” to pull the fuel line and filter from the tank.
3. Remove the filter from the line and install the new filter.

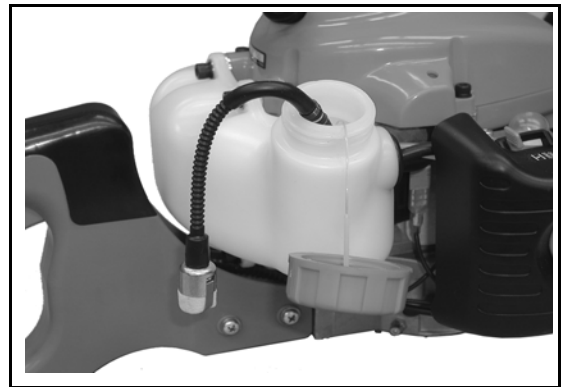

Note: Federal EPA regulations require all model year 2012 and later gasoline powered engines produced for sale in the United States to be equipped with a special low permeation fuel supply hose between the carburetor and fuel tank. When servicing model year 2012 and later equipment, only fuel supply hoses certified by EPA can be used to replace the original equipment supply hose. Fines up to \$37,500 may be enforced for using an un-certified replacement part

Spark Plug

Level 2.

Parts Required: REPOWER™ Tune-Up Kit

NOTICE

Use only NGK BPM-8Y spark plug (BPMR-8Y in Canada) otherwise severe engine damage may occur.

1. Remove spark plug and check for fouling, worn and rounded center electrode.
2. Clean the plug or replace with a new one. DO NOT sand blast to clean. Remaining sand will damage engine.
3. Adjust spark plug gap by bending outer electrode.
4. Tighten spark plug to 150-170 kgf • cm (130-150 in • lbf).

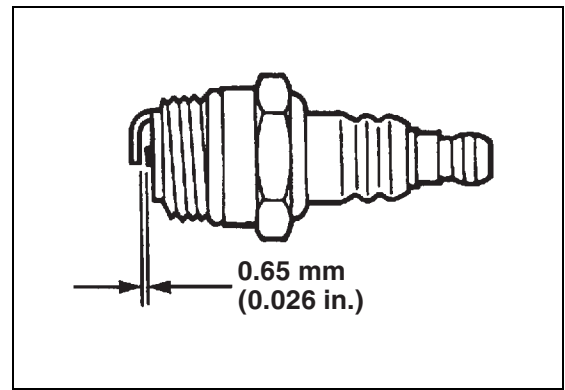

Cooling System

Level 2.

Parts Required: None if you are careful.

NOTICE

To maintain proper engine operating temperatures, cooling air must pass freely through the cylinder fin area. This flow of air carries combustion heat away from the engine.

Overheating and engine seizure can occur when:

- Air intakes are blocked, preventing cooling air from reaching the cylinder.
- Dust and grass build up on the outside of the cylinder. This build up insulates the engine and prevents the heat from leaving.

Removal of cooling passage blockages or cleaning of cooling fins is considered "Normal Maintenance." Any failure attributed to lack of maintenance is not warranted.

1. Remove spark plug lead.
2. Remove engine cover (A).
3. Use brush to remove dirt from the cylinder fins.

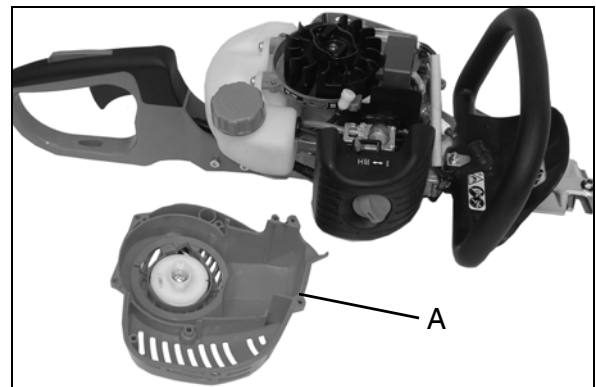

NOTICE

DO NOT use a metal scraper to remove dirt from the cylinder fins.

4. Assemble components in reverse order.

Exhaust System

Spark Arrestor Screen

Level 2.

Parts Required: Spark Arrestor Screen, Gasket

1. Remove spark plug lead.
 2. Remove engine cover (A) and muffler cover (B).
 3. Place piston at Top Dead Center (TDC) to prevent carbon/dirt from entering cylinder.
 4. Remove exhaust guide (C), gasket (D), and screen (E) from muffler body.
 5. Clean carbon deposits from muffler components.
- Note: When cleaning carbon deposits, be careful not to damage the catalytic element inside muffler.
6. Replace screen if it is cracked, plugged, or has holes burned through.
 7. Assemble components in reverse order.

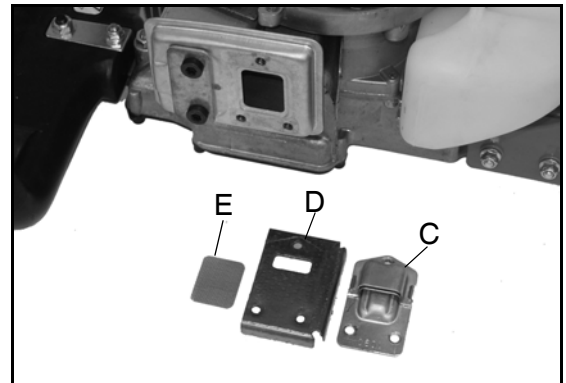
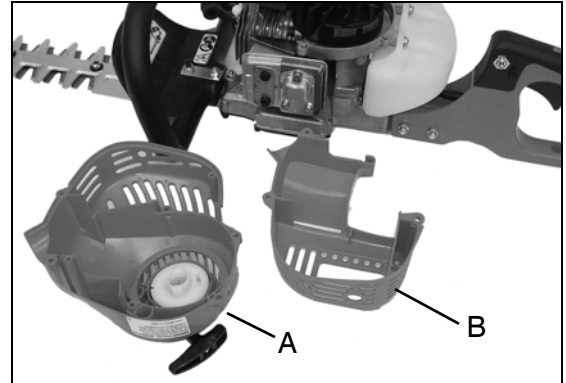

Exhaust Port Cleaning

Level 2.

Parts Required: As needed: Heat Shield

1. Remove spark plug lead from spark plug, and remove engine cover.
2. Place piston at top dead center. Remove muffler (F) and heat shield (G).
3. Use a wood or plastic scraping tool to clean deposits from cylinder exhaust port.

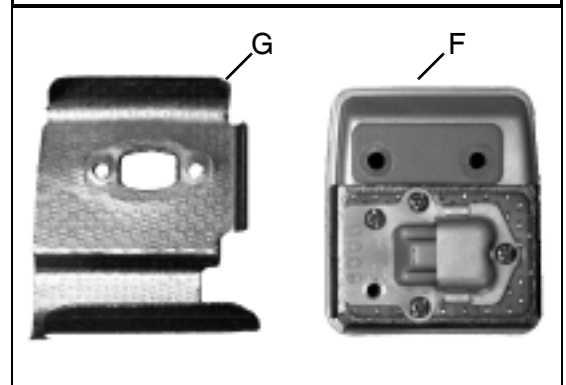

NOTICE

Never use a metal tool to scrape carbon from the exhaust port. Do not scratch the cylinder or piston when cleaning the exhaust port. Do not allow carbon particles to enter the cylinder.

4. Inspect heat shield, and replace if damaged.
5. Install heat shield and muffler.
6. Tighten muffler mounting bolts (or nuts) to 80-95 in•lb (90-110 kgf•cm).
7. Install engine cover and attach spark plug lead.
8. Start engine, and warm to operating temperature.
9. Stop engine, and re-tighten mounting bolts (or nuts) to specifications.

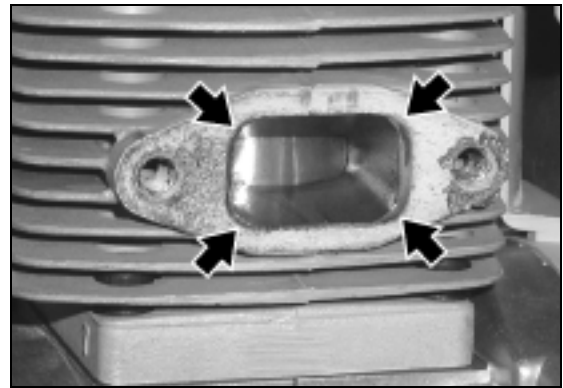

Carburetor Adjustment

⚠ WARNING

The blades must not move at idle, otherwise serious personal injury may result. Periodic carburetor adjustment may be necessary to assure blades do not move at idle.

If blades move, readjust carburetor according to these instructions, or see your ECHO Dealer.

Engine Break-In

New engines must be operated a minimum duration of two tanks of fuel break-in before carburetor adjustments can be made. During the break-in period your engine performance will increase and exhaust emissions will stabilize. Idle speed can be adjusted as required.

High Altitude Operation

This engine has been factory adjusted to maintain satisfactory starting, emission, and durability performance up to 1,100 feet above sea level (ASL) (96.0 kPa). To maintain proper engine operation and emission compliance above 1,100 feet ASL the carburetor may need to be adjusted by an authorized ECHO service dealer.

NOTICE

If the engine is adjusted for operation above 1,100 feet ASL, the carburetor must be re-adjusted when operating the engine below 1,100 feet ASL, otherwise severe engine damage may result.

Level 2.

Parts Required: None

Note: Every unit is run at the factory and the carburetor is set in compliance with emission regulations. Carburetor adjustments, other than idle speed, must be performed by an authorized ECHO dealer.

1. Check idle speed and reset if necessary. If a tachometer is available, idle speed screw (H) should be set to the specifications found on “Specifications” page of this manual. Turn idle screw (H) clockwise to increase idle speed; counter clockwise to decrease idle speed.

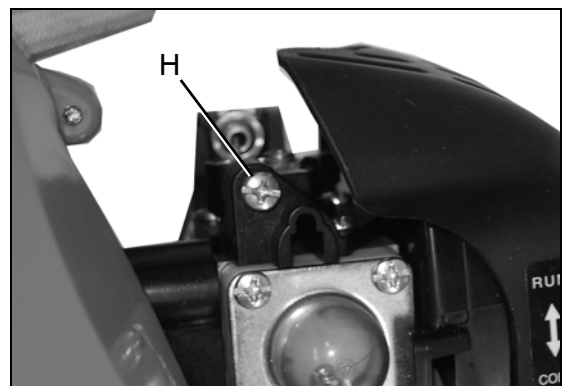

⚠ WARNING

When carburetor adjustment is completed, the cutting attachment should not move at idle, otherwise serious personal injury may result.

Lubrication

Blades

Level 1.

Parts Required: 20W Engine Oil (blade lubrication), 50-50 mixture of kerosene and 20W oil (blade cleaning)

⚠ WARNING

Hedge Clipper blades are very sharp. Touching them may lead to severe personal injury. Avoid touching blades whenever possible, and always wear gloves to protect hands.

1. Move stop switch to stop position.
2. Disconnect spark plug wire from spark plug.
3. Brush loose debris from blade and coat both sides of blade with the 50-50 cleaning mixture.
4. Allow cleaning mixture to soften the remaining gummy residue then wipe it from the blade..
5. Apply clean oil to the entire length of the blade. Be certain the blade bolts are lubricated.
6. Wipe excess oil from the blade before putting the unit back in service.

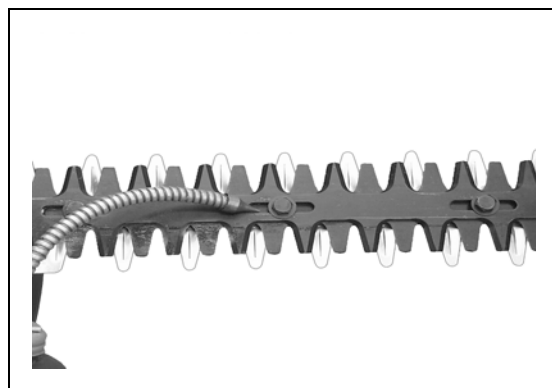
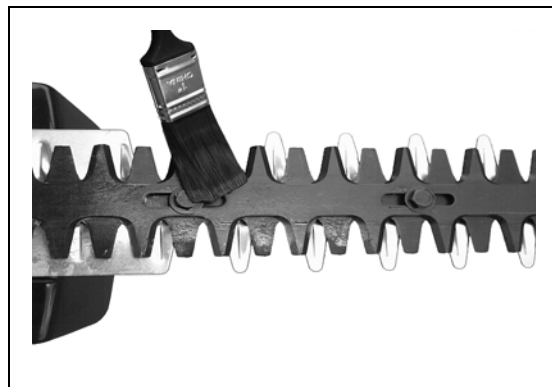

Gear Box

Level 1.

Parts Required: POWER BLENDX™ 14 oz. or Lithium Base Grease.



1. Clean dirt from the grease fitting (A).
2. Apply 1-2 pumps of grease into fitting, DO NOT over fill. Leave room for the grease to expand during operation
3. Wipe excess grease from around grease fitting.

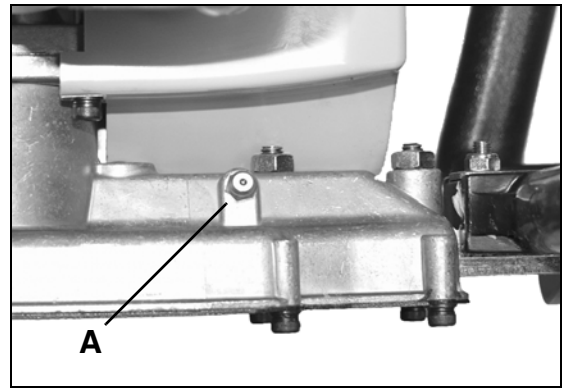

Blades

NOTICE

Blades should only be removed and reinstalled by an Authorized ECHO Servicing Dealer, otherwise premature wear or internal damage may occur.

Sharpening

Level 2.

Parts Required: none

⚠ WARNING

Hedge Clipper blades are very sharp. Touching them may lead to severe personal injury. Avoid touching blades whenever possible, and always wear gloves to protect hands.

1. Move stop switch to stop position.
2. Disconnect spark plug wire.
3. Remove blade guard, if installed (see “Blade Guard Remove/Install instructions”).
4. Slide blades to allow file clearance using slots (A) on bottom of blade. Do not pry against cutting edges.
5. File each edge carefully. Follow the original shape of the blade.

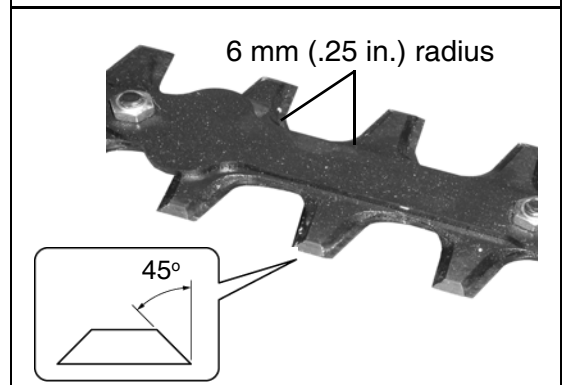
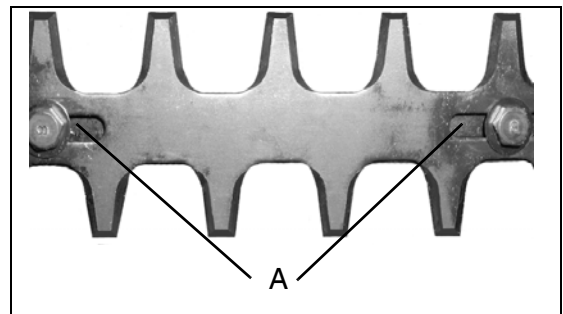

NOTICE

If a power grinder is used DO NOT allow blade to over heat.

6. Install blade guard, if necessary (see “Blade Guard Remove/Install instructions”).
7. Lubricate blades (see “Lubrication”).
8. Connect spark plug wire.

Adjustment

Level 2.

Parts Required: none

WARNING

Hedge clipper blades are very sharp. Touching them may lead to severe personal injury. Use a socket and extension when adjusting blade bolts or blade locknuts in order to keep hands at a safe distance from sharp blades.

1. Tighten blade bolts until snug, then loosen blade bolts 1/2 turn.
2. Hold blade bolts from turning using 10 mm socket, and tighten blade lock nuts with other 10 mm socket.

NOTICE

Locking ability of Hedge Clipper blade lock nuts will diminish each time they are removed. Replace if turning resistance is not felt when installing locknuts.

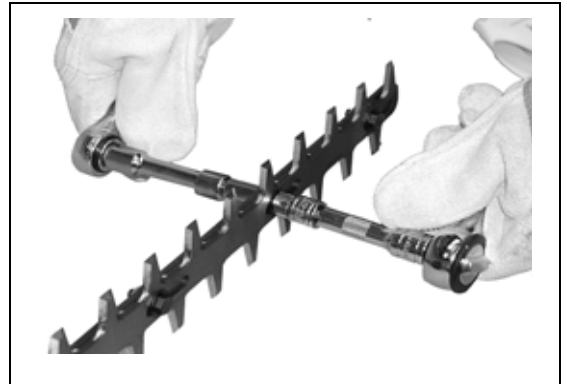

TROUBLESHOOTING

ENGINE PROBLEM TROUBLESHOOTING CHART				
Problem	Check	Status	Cause	Remedy
Engine cranks - starts hard/ doesn't start	Fuel at carburetor	No fuel at carburetor	Fuel strainer clogged Fuel line clogged Carburetor	Clean or replace Clean or replace See your Echo dealer
	Fuel at cylinder	No fuel at cylinder	Carburetor	See your Echo dealer
		Muffler wet with fuel	Fuel Mixture too rich	Open choke Clean/replace air filter Adjust carburetor See your Echo dealer
	Spark at end of plug wire	No spark	Stop switch off Electrical problem Interlock switch	Turn switch to ON See your Echo dealer See your Echo dealer
	Spark at plug	No spark	Spark gap incorrect Covered with carbon Fouled with fuel Plug defective	Adjust to .65mm (0.026 in.) Clean or replace Clean or replace Replace plug
Engine runs, but dies or does not accelerate properly	Air filter	Air filter dirty	Normal wear	Clean or replace
	Fuel filter	Fuel filter dirty	Contaminants/residues in fuel	Replace
	Fuel vent	Fuel vent plugged	Contaminants/residues in fuel	Clean or replace
	Spark Plug	Plug dirty/worn	Normal wear	Clean and adjust or replace
	Carburetor	Improper adjustment	Vibration	Adjust
	Cooling System	Cooling system dirty/plugged	Extended operation in dirty/dusty locations	Clean
	Spark Arrestor Screen	Spark arrestor screen plugged	Normal wear	Replace
Engine does not crank	N/A	N/A	Internal engine problem	See your Echo dealer

⚠ DANGER

Fuel vapors are extremely flammable and may cause fire and/or explosion. Never test for ignition spark by grounding spark plug near cylinder plug hole, otherwise serious personal injury may result.

STORAGE

WARNING

The muffler and surrounding cover become hot during operation. Always keep exhaust area clear of flammable debris during transportation or when storing, otherwise serious property damage or personal injury may result.

Long Term Storage (Over 30 Days)

Do not store your unit for a prolonged period of time (30 days or longer) without performing protective storage maintenance which includes the following:

1. Store unit in a dry, dust free place, out of the reach of children.

WARNING

Hedge Clipper blades are very sharp. Touching them may lead to severe personal injury. Avoid touching blades whenever possible, and always wear gloves to protect hands.

DANGER

Do not store in enclosure where fuel fumes may accumulate or reach an open flame or spark, otherwise serious personal injury may result.

2. Place the stop switch in the “STOP” position.
3. Remove accumulation of grease, oil, dirt and debris from exterior of unit.
4. Perform all periodic lubrication and services that are required.
5. Apply clean oil to the entire length of the blade. Be certain the blade bolts are lubricated.
6. Install blade cover on blades.
7. Tighten all the screws and nuts.
8. Drain fuel tank completely. Press purge bulb 6 -7 times to remove remaining fuel from carburetor then drain the tank again. Close choke, start and run the engine until it stops due to lack of fuel.
9. Allow the engine to cool, then remove the spark plug and pour 7 cc (1/4 oz.) of fresh, clean, two-stroke engine oil into the cylinder through the spark plug hole.
 - a. Place a clean cloth over the spark plug hole.
 - b. Pull the recoil starter handle 2-3 times to distribute the oil inside the engine.
 - c. Observe the piston location through the spark plug hole. Pull the recoil handle slowly until the piston reaches the top of its travel and leave it there.
10. Install the spark plug (do not connect ignition cable).

NOTICE

Always store and transport hedge clippers in a stable, horizontal position. Support gear case and cutting blades to prevent excessive flexing, which may cause damage to these components. Always install blade cover when transporting or storing unit.

SPECIFICATIONS

MODEL	HC-152
Length	1074 mm (42.3 in.)
Width	274 mm (10.8 in.)
Height	199 mm (7.83 in.)
Weight (dry)	5.33 kg (11.8 lb.)
Engine Type	Air cooled, two-stroke, single cylinder gasoline engine
Bore	32.2 mm (1.27 in.)
Stroke	26.0 mm (1.02 in.)
Displacement	21.2 cc (1.29 cu. in.)
Exhaust	Spark arrestor muffler or spark arrestor muffler with catalyst
Carburetor	Diaphragm w/purge pump
Ignition System	Flywheel magneto, capacitor discharge ignition type
Spark Plug	NGK BPM-8Y (Gap 0.65 mm (0.026 in.))
Fuel	Mixed (Gasoline and Two-stroke Oil)
Fuel/Oil Ratio	50 : 1 Power Blend X™ ISO-L-EGD (ISO/CD 13738) and J.A.S.O. M345- <u>FD</u> , two-stroke, air-cooled engine oil.
Gasoline	Use 89 Octane unleaded. Do not use fuel containing methyl alcohol, more than 10% ethyl alcohol or 15% MTBE. Do not use alternative fuels such as E-15 or E-85.
Oil	Power Blend X™ Premium Universal 2-Stroke Oil
Fuel Tank Capacity	0.46 lit. (15.6 US fl. oz.)
Starter System	Automatic Rrecoil Starter
Clutch	Centrifugal Type
Gear Case Ratio	5.88:1
Cutter	Double Reciprocating Blade, Double Edge
Length	477mm (18.8 in.)
Pitch	35mm (1.38 in.)
Height	21mm (0.83 in.)
Maximum Diameter Cut	
Soft Material	25.4mm (1 in.)
Woody Material	13mm (1/2 in.)
Idle Speed	3,300 RPM
Clutch Engagement Speed	4,900 RPM
Wide Open Throttle Speed (W.O.T.)	11,300 RPM

WARRANTY STATEMENTS

ECHO LIMITED WARRANTY STATEMENT FOR PRODUCT SOLD IN USA AND CANADA BEGINNING 01/01/2010

ECHO'S RESPONSIBILITY

ECHO Incorporated's Limited Warranty, provides to the original purchaser that this ECHO product is free from defects in material and workmanship. Under normal use and maintenance from date of purchase, ECHO agrees to repair or replace at ECHO's discretion, any defective product free of charge at any authorized ECHO servicing dealer within listed below application time periods, limitations and exclusions. **THIS LIMITED WARRANTY IS ONLY APPLICABLE TO ECHO PRODUCTS SOLD BY AUTHORIZED ECHO DEALERS. IT IS EXTENDED TO THE ORIGINAL PURCHASER ONLY, AND IS NOT TRANSFERABLE TO SUBSEQUENT OWNERS EXCEPT FOR EMISSION RELATED PARTS.** Repair parts and accessories replaced under this warranty are warranted only for the balance of the original unit or accessory warranty period. Any damage caused by improper installation or improper maintenance is not covered by this warranty. All parts or products replaced under warranty become the property of ECHO, Inc. This warranty is separate from the Emission control warranty statement supplied with your new product. Please consult the Emission Control Warranty Statement for details regarding emission related parts. For a list of Authorized ECHO Dealers refer to WWW.ECHO-USA.COM or call 1-800-432-ECHO.

OWNER'S RESPONSIBILITY

To ensure trouble free warranty coverage it is important that you register your ECHO equipment on-line at WWW.ECHO-USA.COM or by filling out the warranty registration card supplied with your unit. Registering your product confirms your warranty coverage and provides a direct link if we find it necessary to contact you.

The owner shall demonstrate reasonable care and use, and follow preventative maintenance, storage, fuel and oil usage as prescribed in the operator's manual. Should a product difficulty occur, you must, at your expense, deliver or ship your ECHO unit to an authorized ECHO servicing dealer for warranty repairs (within the applicable warranty period), and arrange for pick-up or return of your unit after the repairs have been made. For your nearest authorized ECHO servicing dealer, call ECHO's Dealer Referral Center, at 1-800-432-ECHO or you can locate an ECHO servicing dealer at WWW.ECHO-USA.COM. Should you require assistance or have questions concerning ECHO's Warranty Statement, you can contact our Consumer Product Support Department at 1-800-673-1558 or contact us through the web at WWW.ECHO-USA.COM.

PRODUCT WARRANTY PERIOD

RESIDENTIAL APPLICATION

- **5 YEAR WARRANTY** - All units for residential, or non-income producing use will be covered by this limited warranty for **five (5) years** from date of purchase.

EXCEPTIONS:

- For two-stroke engine powered products, the electronic ignition module, flexible drive cables, SRM solid drive shafts, and TC tines are warranted for the **life*** of the product on parts only.
- Cutting attachments such as, but not limited to, bars, chains, sprockets, blades, and nylon trimmer heads for residential or non-income producing use will be covered for failures due to defects in material or workmanship for a period of **60 days** from original product purchase date. Any misuse from contact with concrete, rocks, or other structures is not covered by this warranty.
- ECHO's Rapid Loader String Head carries a lifetime warranty on the line locking system, parts only; no labor. Refer to your operator's manual for string head installation and maintenance instructions.
- All SB-Series and PRO ATTACHMENT SERIES Split Shaft attachments carry the same warranty duration as the units they are designed to fit.

COMMERCIAL APPLICATION

- **1 YEAR WARRANTY** - All Chain Saws, QuikVent Saws, and Cut-Off Saws for commercial, institutional, agricultural, industrial, or income producing use will be covered by this limited warranty for one **(1) year** from the date of purchase.
- **2 YEAR WARRANTY** - All other units for commercial, institutional, agricultural, industrial, or income producing use will be covered by this limited warranty for two **(2) years** from the date of purchase.

EXCEPTIONS:

- For two-stroke engine powered products, the electronic ignition module, flexible drive cables, SRM solid drive shafts and TC tines, are warranted for the **life*** of the product on parts only.
- Cutting attachments such as, but not limited to, bars, chains, sprockets, blades, and nylon trimmer heads for commercial, institutional, agricultural, industrial, rental, or income producing will be covered for failures due to defects in material or workmanship for a period of **30 days** from original product purchase date. Any misuse from contact with concrete, rocks, or other structures is not covered by this warranty.
- ECHO's Rapid Loader String Head carries a lifetime warranty on the line locking system, parts only; no labor. Refer to your operator's manual for string head installation and maintenance instructions.
- All SB-Series and PRO ATTACHMENT SERIES Split Shaft attachments carry the same warranty duration as the units they are designed to fit.

RENTAL APPLICATION - 90 DAYS WARRANTY

- Units for rental use will be covered against defects in material and workmanship for a period of 90 days from the date of purchase.

* ECHO's liability under the "Lifetime" coverage is limited to furnishing parts specified under the PRODUCT WARRANTY PERIOD section of this warranty statement for "Life" free of charge for a period of ten (10) years after the date of the complete unit's final production.

PURCHASED REPAIR PARTS, SHORT BLOCKS AND ACCESSORIES

- 90-day residential, or non-income producing warranty
- 30-day commercial, institutional, agricultural, industrial, income producing, or rental application warranty

ATTENTION TWO-STROKE ENGINE POWER PRODUCT OWNERS

This ECHO two-stroke engine power product is a quality-engineered unit which has been manufactured to exact tolerances to provide superior performance. To help ensure the performance of the unit, it is required to use two-stroke oil which meets the ISO-L-EGD Standard per ISO/CD 13738 and JASO M345FD Standards. **ECHO Power Blend™ Two-Stroke Oil** is a premium two-stroke oil specifically formulated to meet ISO-L-EGD (ISO/CD 13738) and JASO M345FD Standards. The use of two-stroke oils designed for other applications, such as for outboard motors or lawnmowers can result in severe engine damage, and will void your two-stroke engine limited warranty.

THIS WARRANTY DOES NOT COVER DAMAGE CAUSED BY:

- Lack of lubrication or engine failure, due to the use of two-stroke oils that do not meet the ISO-L-EGD (ISO/CD 13738) and JASO M345FD Standards. Engine problems due to inadequate lubrication caused by failure to use an ISO-L-EGD compliant and JASO M345FD registered oil, will void the two-stroke engine limited warranty. **ECHO Power Blend™ Two-Stroke Oil** meets the ISO-L-EGD and JASO M345FD Standard. Emission related parts are covered for 5 years residential use or 2 years commercial use regardless of two-stroke oil used, per the statement listed in the EPA or California Emission Defect Warranty Explanation.
- Damage caused by use of gasohol, containing methanol (wood alcohol), or gasoline containing less than 89 octane. Only use gasoline which contains 89 octane or higher. Gasohol which contains a **maximum** 10% ethanol (grain alcohol) or 15% MTBE (methyl/tertiary/butyl/ether) is also approved. The prescribed mixing ratio of gasoline to oil is listed on the ECHO oil label and covered in your operator's manual.
- Engine damage caused by use of ether or any starting fluids.
- Damage caused by tampering with engine speed governor or emission components, or running engines above specified and recommended engine speeds as listed in your operator's manual.
- Operation of the unit with improperly maintained/removed cutting shield or removed/damaged air filter.
- Damage caused by dirt, pressure or steam cleaning the unit, salt water, corrosion, rust, varnish, abrasives, and moisture.
- Defects, malfunctions or failures resulting from abuse, misuse, neglect, modifications, alterations, normal wear, improper servicing, or use of unauthorized attachments.
- Incorrect storage procedures, stale fuel, including failure to provide or perform required maintenance services as prescribed in the operator's manual. Preventative maintenance as outlined in the operators manual is the customer's responsibility.
- Failures due to improper set-up, pre-delivery service or repair service by anyone other than authorized ECHO servicing dealer during the warranty period.
- Certain parts and other items are not warranted, including but not limited to: lubricants, starter cords, and engine tune-ups.
- Use of spark plugs other than those meeting performance and durability requirements of the OEM spark plug listed in the Operator's Manuals.
- Overheating or carbon scoring failures due to restricted, clogged exhaust port or combustion chamber, including damage to spark arrester screen.
- Adjustments after the first (30) thirty days and beyond, such as carburetor adjustment and throttle cable adjustment.
- Damage to gears or gear cases caused by contaminated grease or oil, use of incorrect type or viscosity of lubricants, and/or failure to comply with recommended grease or oil change intervals.
- Damage caused by loading SHRED 'N' VAC® beyond recommended capacity.
- Damage caused by pump or sprayer running dry, pumping or spraying caustic or flammable materials, or lack of or broken strainers.
- Additional damage to parts or components due to continued use after operational problem or failure occurs. Should operational problem or failure occur, the product should not be used, but delivered as is to an authorized ECHO servicing dealer.

It is a dealer's and/or customer's responsibility to complete and return the warranty registration card supplied with your ECHO product or by visiting WWW.ECHO-USA.COM. Your receipt of purchase including date, model and serial number must be maintained and presented to an authorized ECHO servicing dealer for warranty service. Proof of purchase rests solely with the customer. Some states do not allow limitations on how long an implied warranty lasts, so the above limitations may not apply to you. Some states do not allow the exclusion or limitation of incidental or consequential damages, so you may also have other specific legal rights which vary from state to state. This limited warranty is given by ECHO Incorporated, 400 Oakwood Rd., Lake Zurich, IL 60047.

DISCLAIMER OF IMPLIED WARRANTIES

This limited warranty is in lieu of all other expressed or implied warranties, including any warranty of FITNESS FOR A PARTICULAR PURPOSE OR USE and any implied warranty of **MERCHANTABILITY** otherwise applicable to this product. ECHO and its affiliated companies shall not be liable for any special incidental or consequential damage, including lost profits. There are no warranties extended other than as provided herein. This limited warranty may be modified only by ECHO.

99922201032
11/18/2011

NOTES



ECHO, INCORPORATED

400 Oakwood Road
Lake Zurich, IL 60047
www.echo-usa.com

S94111001001/S94111999999
S94012001001/S94012999999