



Power Blower

Operator's Manual

MODEL

PB-231LN

WARNING  **DANGER**



The muffler or catalytic muffler and surrounding cover may become extremely hot.

Always keep clear of exhaust and muffler area, otherwise serious personal injury may occur.



WARNING



The engine exhaust from this product contains chemicals known to the State of California to cause cancer, birth defects or other reproductive harm.



WARNING  **DANGER**

Read rules for safe operation and all instructions carefully. ECHO provides this Operator's Manual which must be read and understood for proper and safe operation.

INTRODUCTION

Welcome to the ECHO family. This ECHO product was designed and manufactured to provide long life and on-the-job dependability. Read and understand this manual. You will find it easy to use and full of helpful operating tips and SAFETY messages.

THE OPERATOR'S MANUAL

Read and understand this manual before operation. Keep it in a safe place for future reference. It contains specifications and information for operation, starting, stopping, maintenance, storage and assembly specific to this product.

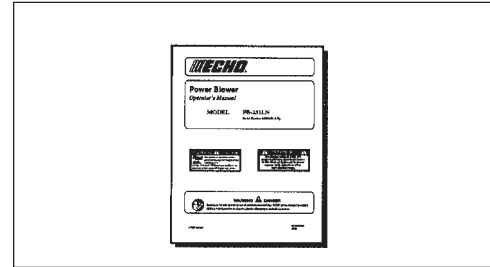

TABLE OF CONTENTS

Introduction	2	Maintenance	13
- The Operator's Manual	2	- Skill Levels	13
Safety	3	- Maintenance Intervals	13
- Manual Safety Symbols and Important Information	3	- Air Filter	14
- International Symbols	3	- Fuel Filter	14
- Personal Condition and Safety Equipment	4	- Spark Plug	15
- Equipment Check	6	- Cooling System	15
Emission Control	6	- Exhaust System	16
Description	7	- Carburetor Adjustment	17
Contents	8	Troubleshooting	18
Assembly	9	Storage	19
- Blower Application	9	Specifications	20
Operation	9	Servicing Information	24
- Fuel	9	- Parts/Serial Number	24
- Starting Cold Engine	10	- Service	24
- Starting Warm Engine	11	- ECHO Consumer Product Support	24
- Stopping Engine	12	- Warranty Card	24
- Operating Blower	12	- Additional or Replacement Manuals	24

Specifications, descriptions and illustrative material in this literature are as accurate as known at the time of publication, but are subject to change without notice. Illustrations may include optional equipment and accessories, and may not include all standard equipment.

SAFETY

MANUAL SAFETY SYMBOLS AND IMPORTANT INFORMATION

Throughout this manual and on the product itself, you will find safety alerts and helpful, informational messages preceded by symbols or key words. The following is an explanation of those symbols and key words and what they mean to you.

 This symbol accompanied by the words **WARNING** and **DANGER** calls attention to an act or condition that can lead to serious personal injury to operator and bystanders.











 The circle with the slash symbol means whatever is shown within the circle is prohibited.









 
IMPORTANT **NOTE**

IMPORTANT
The enclosed message provides information necessary for the protection of the unit.

NOTE
This enclosed message provides tips for use, care and maintenance of the unit.

INTERNATIONAL SYMBOLS

Symbol form/shape	Symbol description/application	Symbol form/shape	Symbol description/application
	Read and understand Operator's Manual.		Fuel and oil mixture
	Wear eyes, ears and head protection		Finger Severing
	Hot Surface		Wear hand protection. Use two handed.
	Safety/Alert		Wear slip resistant foot wear.
	DO NOT allow flames or sparks near fuel.		DO NOT smoke near fuel.

Symbol form/shape	Symbol description/application	Symbol form/shape	Symbol description/application
	Emergency stop		Ignition ON/OFF
	Carburetor adjustment - Low speed mixture		Primer bulb
	Carburetor adjustment - Idle speed		Carburetor adjustment - High speed mixture
	Choke Control "Cold Start" Position (Choke Closed)		Choke Control "Run" Position (Choke Open)

PERSONAL CONDITION AND SAFETY EQUIPMENT

WARNING  **DANGER**

Power Blower users risk injury to themselves and others if the power blower is used improperly or safety precautions are not followed. Proper clothing and safety gear must be worn when operating a blower.

Physical Condition

Your judgment and physical dexterity may not be good:

- if you are tired or sick,
- if you are taking medication,
- if you have taken alcohol or drugs.

Operate unit only if you are physically and mentally well.

Eye Protection

Wear eye protection that meets ANSI Z87.1 or CE requirements whenever you operate the unit.

Hand Protection

Wear no-slip, heavy-duty work gloves to improve your grip on the blower handle. Gloves also reduce the transmission of machine vibration to your hands.

Breathing Protection

Wear a facemask to protect against dust.

Hearing Protection

ECHO recommends wearing hearing protection whenever unit is used.

Proper Clothing

Wear snug fitting, durable clothing;

- Pants should have long legs, shirts with long sleeves.
- **DO NOT WEAR SHORTS,**
- **DO NOT WEAR TIES, SCARVES, and JEWELRY.**

Wear sturdy work shoes with nonskid soles:

- **DO NOT WEAR OPEN TOED SHOES,**
- **DO NOT OPERATE UNIT BAREFOOTED.**

Keep long hair away from engine and blower intake. Retain hair with cap or net.

Hot Humid Weather

Heavy protective clothing can increase operator fatigue, which may lead to heat stroke. Schedule heavy work for early morning or late afternoon hours when temperatures are cooler.

Vibration and Cold

It is believed that a condition called Raynaud's Phenomenon, which affects the fingers of certain individuals, may be brought about by exposure to vibration and cold. Exposure to vibration and cold may cause tingling and burning sensations, followed by loss of color and numbness in the fingers. The following precautions are strongly recommended, because the minimum exposure, which might trigger the ailment, is unknown.

- Keep your body warm, especially the head, neck, feet, ankles, hands, and wrists.
- Maintain good blood circulation by performing vigorous arm exercises during frequent work breaks, and also by not smoking.
- Limit the hours of operation. Try to fill each day with jobs where operating the unit or other hand-held power equipment is not required.
- If you experience discomfort, redness, and swelling of the fingers followed by whitening and loss of feeling, consult your physician before further exposing yourself to cold and vibration.



Repetitive Stress Injuries

It is believed that overusing the muscles and tendons of the fingers, hands, arms, and shoulders may cause soreness, swelling, numbness, weakness, and extreme pain in those areas. Certain repetitive hand activities may put you at a high risk for developing a Repetitive Stress Injury (RSI). An extreme RSI condition is Carpal Tunnel Syndrome (CTS), which could occur when your wrist swells and squeezes a vital nerve that runs through the area.

Some believe that prolonged exposure to vibration may contribute to CTS. CTS can cause severe pain for months or even years.

To reduce the risk of RSI/CTS, do the following:

- Avoid using your wrist in a bent, extended, or twisted position. Instead try to maintain a straight wrist position. Also, when grasping, use your whole hand, not just the thumb and index finger.
- Take periodic breaks to minimize repetition and rest your hands.
- Reduce the speed and force with which you do the repetitive movement.
- Do exercises to strengthen the hand and arm muscles.
- Immediately stop using all power equipment and consult a doctor if you feel tingling, numbness, or pain in the fingers, hands, wrists, or arms. The sooner RSI/CTS is diagnosed, the more likely permanent nerve and muscle damage can be prevented.

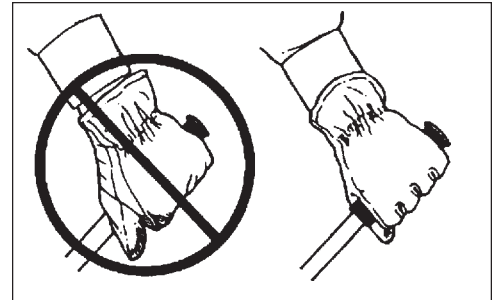

WARNING  **DANGER**

Do not operate this product indoors or in inadequately ventilated areas. Engine exhaust contains poisonous emissions and can cause serious injury or death.

Read the Manuals

- Provide all users of this equipment with the Operator's Manual and Safety Manual for instructions on Safe Operation.

Clear the Work Area

- Spectators and fellow workers must be warned, and children and animals prevented from coming nearer than 15 m (50 ft.) while the unit is in use.
- Take wind conditions into account: avoid open doors and windows.
- Do not point blower at people or animals.
- Review area to be cleared. Look for potential hazards such as stones or metal objects.

Keep a Firm Grip

- Hold the front and rear handles with both hands, with thumbs and fingers encircling the handles.

Keep a Solid Stance

- Maintain footing and balance at all times. Do not stand on slippery, uneven or unstable surfaces. Do not work in odd positions or on ladders. Do not over reach.

Avoid Hot Surfaces

- Keep exhaust area clear of flammable debris. Avoid contact during and immediately after operation.

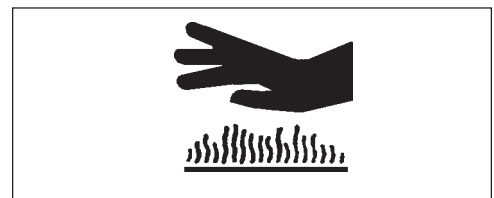

EQUIPMENT CHECK

WARNING DANGER

Use only ECHO approved attachments. Serious injury may result from the use of a non-approved attachment combination. ECHO, INC. will not be responsible for the failure of cutting devices, attachments or accessories which have not been tested and approved by ECHO. Read and comply with all safety instructions listed in this manual and safety manual.

- Check unit for loose/missing nuts, bolts and screws. Tighten and/or replace as needed.
- Inspect fuel lines, tank and area around carburetor for fuel leaks. **DO NOT** operate unit if leaks are found.
- Do not use blower if any part is missing or damaged.
- Have repairs done only by an authorized ECHO Service dealer.
- Do not use any attachment, accessory or replacement part unless it is recommended in this Operator's Manual.

EMISSION CONTROL

California Tier 2

The emission control system for these engines is EM/TWC (Engine Modification and Catalyst).

IMPORTANT ENGINE INFORMATION
ENGINE FAMILY: 6EHXS.0254KB DISPLACEMENT: 22.8cc
EMISSION COMPLIANCE PERIOD: 300 HRS.
THIS ENGINE MEETS U.S. EPA PH2 AND 2005 - 2006
CALIFORNIA EMISSION REGULATIONS FOR SOREs.
REFER TO OWNER'S MANUAL FOR MAINTENANCE
SPECIFICATIONS AND ADJUSTMENTS.



KIORTZ CORP. 

An Emission Control Label is located on the engine. (This is an EXAMPLE ONLY; information on label varies by engine FAMILY).

PRODUCT EMISSION DURABILITY

The 300 hour emission durability period is the time span selected by the manufacturer certifying the engine emissions output meets applicable emissions regulations, provided that approved maintenance procedures are followed as listed in the Maintenance Section of this manual.

DESCRIPTION

Locate these safety decals on your unit. Make sure the decals are legible and that you understand and follow the instructions on them. If a decal cannot be read, a new one can be ordered from your ECHO dealer. See PARTS ORDERING instructions for specific information.

Hot Decal (near muffler)



P/N 89016006361

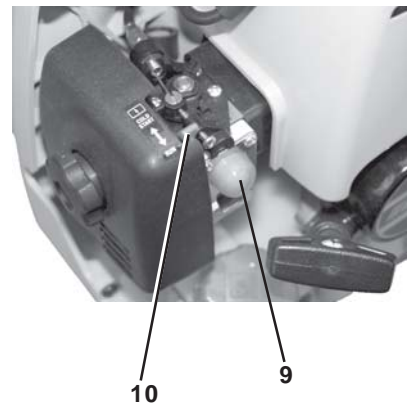
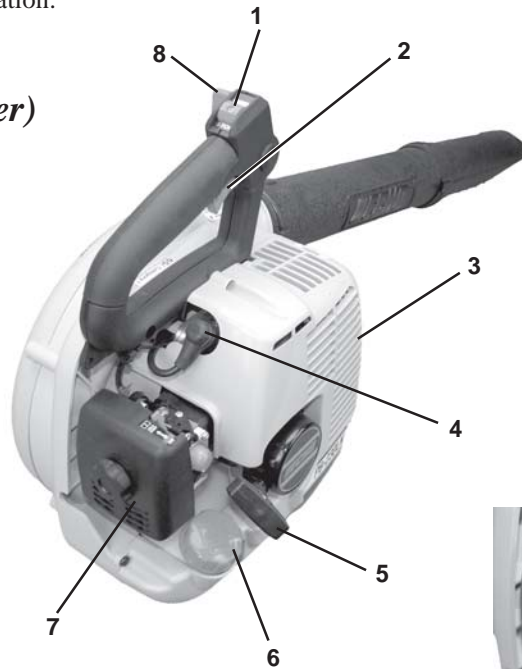



General Warning Decal (located on top of blower housing)



P/N 89016009461



P/N X508000120

1. **STOP SWITCH** - "SLIDE SWITCH" mounted on top of handle. Push forward to start and run. Slide back to stop.
2. **THROTTLE TRIGGER** - Spring loaded to return to idle when released. During acceleration, press trigger gradually for best operating technique.
3. **SPARK ARRESTOR - CATALYTIC MUFFLER / MUFFLER** - The muffler or catalytic muffler controls exhaust noise and emission. The spark arrestor screen prevents hot, glowing particles of carbon from leaving the muffler. Keep exhaust area clear of flammable debris.
4. **SPARK PLUG** - Provides spark to ignite fuel mixture.
5. **RECOIL STARTER HANDLE** - Pull recoil handle slowly until recoil starter engages, then quickly and firmly. When engine starts, return handle slowly. DO NOT let handle snap back or damage to unit will occur.
6. **FUEL TANK CAP** - Covers and seals fuel tank.
7. **AIR CLEANER** - Contains replaceable air filter element.
8. **THROTTLE POSITION LEVER** - Pull back to increase engine speed. Friction washers maintain throttle lever setting.
9. **PURGE BULB** - Pumping purge bulb before starting engine draws fresh fuel from the fuel tank, purging air from the carburetor. Pump purge bulb until fuel is visible and flows freely in the clear fuel tank return line. Pump purge bulb an additional 4 or 5 times..
10. **CHOKE** - Choke is located on top of the air cleaner. Move choke lever to "COLD START" () to close choke for cold start. Move choke lever to "RUN" () position to open choke.
11. **BLOWER PIPES** - Twist lock design.

CONTENTS

- 1 - Power Head
- 1 - Straight Pipe
- 1 - Fan Head Pipe
- 1 - Operator's Manual
- 1 - Warranty Registration Card
- 1 - ECHO Emissions and Warranty Statement
- 1 - Echo Power Blend™ 2-stroke oil sample

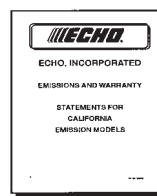
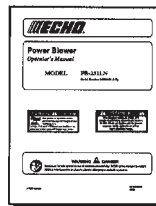

ASSEMBLY

WARNING  DANGER

Never perform maintenance or assembly procedures with engine running or serious personal injury may result.

INSTALL BLOWER PIPES

1. Align grooves in straight pipe with pegs on blower housing and slide pipe onto housing.
2. Turn straight pipe clockwise to lock into place.
3. Align grooves in fan head nozzle with pegs on straight pipe and slide fan head nozzle onto straight pipe.
4. Turn fan head nozzle clockwise to lock into place.



OPERATION

NOTICE: Use of unmixed, improperly mixed, or fuel older than 90 days, (stale fuel), may cause hard starting, poor performance, or severe engine damage and void the product warranty. Read and follow instructions in the Storage section of this manual.

FUEL

Fuel Requirements

Gasoline - Use 89 Octane [R+M/2] (mid grade or higher) gasoline known to be good quality. Gasoline may contain up to 15% MTBE (methyl tertiary-butyl ether). Gasohol containing methyl (wood) alcohol is **NOT** approved.

Two Stroke Oil - A two-stroke engine oil meeting ISO-L-EGD (ISO/CD 13738) and J.A.S.O. FC Standards must be used. Echo brand premium Power Blend™ Universal 2-Stroke Oil meets these standards. Engine problems due to inadequate lubrication caused by failure to use an ISO-L-EGD and J.A.S.O. FC certified oil, such as Echo premium Power Blend™, will void the two-stroke engine warranty. (Emission related parts only are covered for two years, regardless of two-stroke oil used, per the statement listed in the Emission Defect Warranty Explanation.)

Fuel to Oil Mix - 50:1 Ratio			
U.S.		METRIC	
GAS	OIL	GAS	OIL
Gallons	Fl. oz.	Liter	cc.
1	2.6	4	80
2	5.2	8	160
5	13	20	400

IMPORTANT

Echo premium Power Blend™ Universal 2-Stroke Oil may be mixed at 50:1 ratio for application in all Echo engines sold in the past regardless of ratio specified in those manuals.

Handling Fuel

WARNING DANGER

Fuel is VERY flammable. Use extreme care when mixing, storing or handling or serious personal injury may result.

- Use an approved fuel container.
- DO NOT smoke near fuel.
- DO NOT allow flames or sparks near fuel.
- Fuel tanks/cans may be under pressure. Always loosen fuel caps slowly allowing pressure to equalize.
- NEVER refuel a unit when the engine is HOT or RUNNING!
- DO NOT fill fuel tanks indoors. ALWAYS fill fuel tanks outdoors over bare ground.
- DO NOT overfill fuel tank. Wipe up spills immediately.
- Securely tighten fuel tank cap and close fuel container after refueling.
- Inspect for fuel leakage. If fuel leakage is found, do not start or operate unit until leakage is repaired.
- Move at least 3m (10 ft.) from refueling location before starting the engine.

Mixing Instructions

1. Fill an approved fuel container with half of the required amount of gasoline.
2. Add the proper amount of 2-stroke oil to gasoline.
3. Close container and shake to mix oil with gasoline.
4. Add remaining gasoline, close fuel container, and remix.

IMPORTANT

Spilled fuel is a leading cause of hydrocarbon emissions. Some states may require the use of automatic fuel shut-off containers to reduce fuel spillage.

After use

- DO NOT store a unit with fuel in its tank. Leaks can occur. Return unused fuel to an approved fuel storage container.

Storage - Fuel storage laws vary by locality. Contact your local government for the laws affecting your area. As a precaution, store fuel in an approved, airtight container. Store in a well-ventilated, unoccupied building, away from sparks and flames.

IMPORTANT

Stored fuel ages. Do not mix more fuel than you expect to use in thirty (30) days, ninety (90) days when a fuel stabilizer is added.

IMPORTANT

Stored two-stroke fuel may separate. ALWAYS shake fuel container thoroughly before each use.

STARTING COLD ENGINE

1. *Stop Switch*
Move stop switch button (A) away from the STOP position.
2. *Throttle Position Lever*
Move throttle position lever (B) forward to idle position.
3. *Choke*
Move choke (C) to Cold Start () Position.
4. *Purge Bulb*
Pump purge bulb (D) until fuel is visible and flows freely in the clear fuel tank return line. Pump bulb an additional 4 or 5 times.

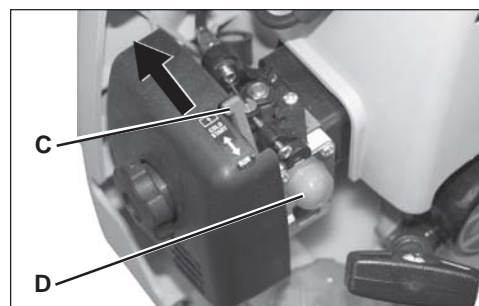
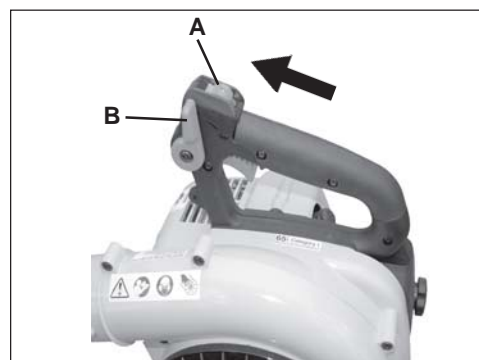

IMPORTANT

Recoil starter: Use short pulls - only 45 ~ 60 cm (18 ~ 24 in.) of rope for starting. Do not allow the rope to snap back in. Always hold the unit firmly.

5. *Recoil Starter*
Place the unit on a flat, clear area. Firmly grasp throttle grip with left hand and rapidly pull recoil starter handle/rope (E) until engine fires (5 ~ 6 pulls maximum).
6. After engine fires (or 5 ~ 6 pulls), move choke lever (C) to Run (|↑|) position and pull recoil starter handle/rope until engine starts and runs. Allow unit to warm up at idle for several minutes.

NOTE

If engine does not start with choke in "Run" position after 5 pulls, repeat instructions.

7. After engine warm up, gradually depress throttle trigger to increase engine RPM to operating speed.

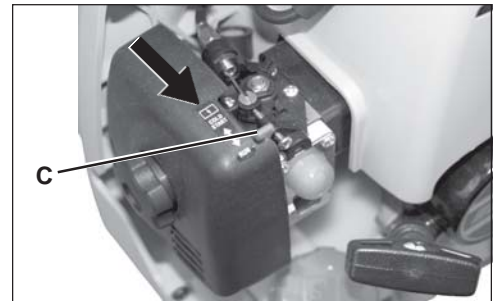
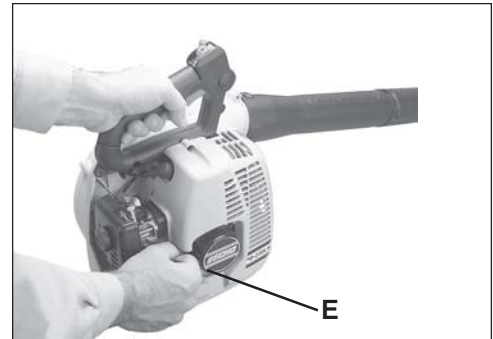

STARTING WARM ENGINE

The starting procedure is the same as Cold Start except DO NOT close the choke.

1. *Stop Switch*
Move stop switch button (A) away from the STOP position.
2. *Throttle Position Lever*
Move throttle position lever (B) forward to idle position.
3. *Purge Bulb*
Pump purge bulb (D) until fuel is visible and flows freely in the clear fuel tank return line. Pump bulb an additional 4 or 5 times.
4. *Recoil Starter*
Place the unit on a flat, clear area. Firmly grasp throttle grip with left hand and rapidly pull recoil starter handle/rope (E) until engine fires.

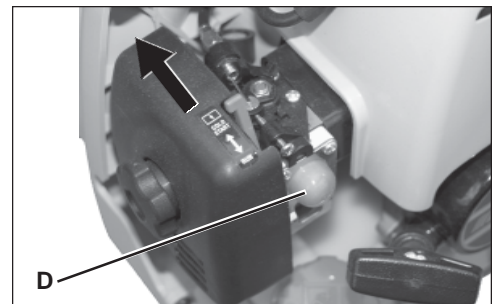
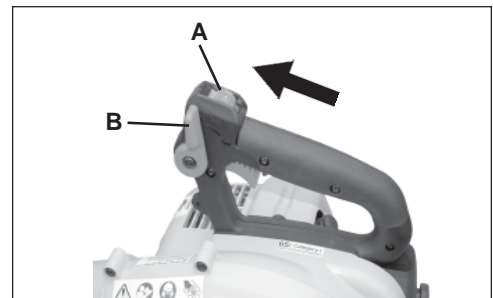

IMPORTANT

Recoil starter: Use short pulls - only 45 ~ 60 cm (18 ~ 24 in.) of rope for starting. Do not allow the rope to snap back in. Always hold the unit firmly.

NOTE

If engine does not start after 5 pulls, use Cold Start Procedure.

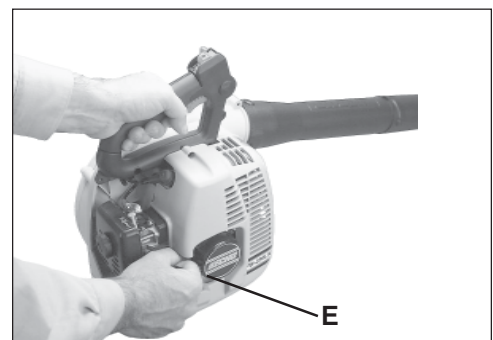

STOPPING ENGINE

1. *Throttle Trigger/Throttle Position Lever*
Release throttle trigger (F). Move throttle position lever (B) forward to idle position and allow engine to return to idle before shutting engine off.
2. *Stop Switch*
Move stop switch (A) to “STOP” position.

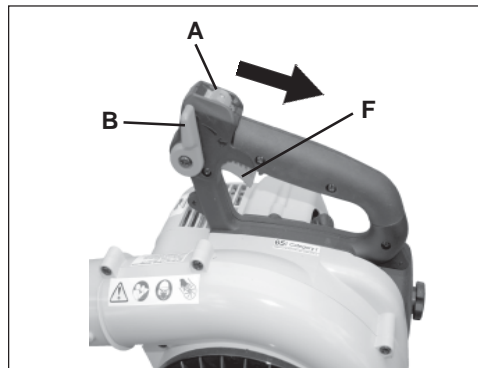

WARNING DANGER

If engine does not stop when stop switch is moved to STOP position, close choke - COLD START position - to stall engine. Have your ECHO dealer repair stop switch before using blower again.

BLOWER OPERATION

WARNING DANGER

Always wear safety glasses, hearing protection and a face filter mask or serious personal injury may result. Do not point the blower pipe in the direction of people or pets.

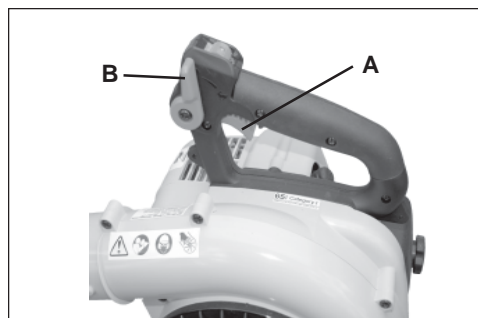

Read the Safety Section carefully.

IMPORTANT

To avoid engine damage due to over-revving, do not block blower pipe.

1. Use only during appropriate hours.
2. Allow the engine to warm up at a fast idle for a few minutes.
3. Control engine speed with throttle trigger (A), or for continuous use, set engine speed with throttle position lever (B). Rotate throttle position lever forward for lower speed, back for higher speed.
4. Use lower speed to blow debris from hard surfaces.
5. Additional speed may be necessary to clean debris, snow, etc. from lawns and flowerbeds.

NOTE

Never use a higher speed setting than necessary to perform a task. Remember, the higher the engine speed, the louder the blower noise. Minimize dust by using blower at lower speeds. Keep debris on your property.
Be Smart - be a good neighbor.



MAINTENANCE

Your ECHO blower is designed to provide many hours of trouble free service. Regular scheduled maintenance will help your blower achieve that goal. If you are unsure or are not equipped with the necessary tools, you may want to take your unit to an ECHO Service Dealer for maintenance. To help you decide whether you want to DO-IT-YOURSELF or have the ECHO Dealer do it, each maintenance task has been graded. If task is not listed, see your ECHO Dealer for repairs.

SKILL LEVEL

- Level 1**= Easy to do. Basic tools are required.
- Level 2**= Moderate difficulty. Some specialized tools may be required.
- Level 3**= Experience required. Specialized tools are required. Echo recommends that the unit be returned to your ECHO dealer for service.

ECHO offers **REPOWER™** Maintenance Kits and Parts to make your maintenance job easier. Just below each task heading are listed the various part numbers required for that task. See your ECHO dealer for these parts.

MAINTENANCE INTERVALS

COMPONENT/ SYSTEM	MAINTENANCE PROCEDURE	REQ'D SKILL LEVEL	DAILY OR BEFORE USE	EVERY REFUEL	3 MONTHS OR 90 HOURS	6 MONTHS OR 270 HOURS	YEARLY
Recommended Echo Dealer Maintenance Procedures							
Cylinder Exhaust Port	Inspect/Clean/Decarbon	3			I / C		
Do-It-Yourself Maintenance Procedures							
Air Filter	Inspect/Clean/Replace	1	I / C		R*		
Choke	Inspect/Clean	2	I / C				
Fuel Filter	Inspect/Replace	1			I		R*
Fuel System, Leaks	Inspect/Replace	1	I	I / R*			
Cooling System	Inspect/Clean	2	I / C				
Muffler Spark Arrestor	Inspect/Replace	2			I / R*		
Recoil Starter Rope	Inspect/Clean	1	I / C				I / R*
Spark Plug	Inspect/Clean	2			I / C	R*	
Screws/Nuts/Bolts	Inspect/Tighten/Replace	1	I / R*				

MAINTENANCE PROCEDURE LETTER CODES: I = INSPECT, R = REPLACE, C = CLEAN

IMPORTANT NOTE - Time intervals shown are maximum. Actual use and your experience will determine the frequency of required maintenance.

MAINTENANCE PROCEDURE NOTES:

* All recommendations to replace are based on the finding of damage or wear during inspection.

AIR FILTER

Level 1.

Tools required: 25-50 mm (1-2 in.) medium bristle paint brush.

Parts required: 90030 REPOWER™ Air and Fuel Filter Kit

NOTE

Clean daily.

1. Close choke (Cold Start Position ). This prevents dirt from entering the carburetor throat when the air filter is removed. Brush accumulated dirt from air cleaner area.
2. Remove air filter cover. Brush dirt from inside cover.
3. Remove air filter and lightly brush debris from filter. Replace filter if it is damaged, fuel soaked, very dirty, or the rubber sealing edges are deformed.
4. If filter can be reused, be certain it:
 - Fits tightly in the air filter cavity.
 - Is installed with the original side out.
5. Install air filter cover.

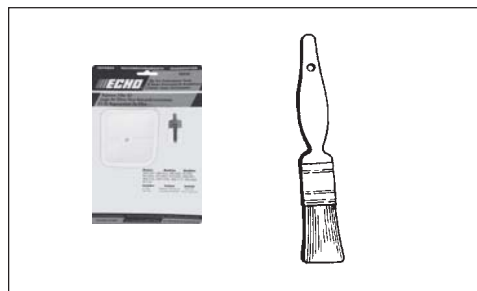

FUEL FILTER

Level 1.

Tools required: Fuel line hook. 200-250 mm (8-10 in.) length of wire with one end bent into a hook. Clean rag, funnel, and an approved fuel container.

Parts required: 90030 REPOWER™ Air and Fuel Filter Kit

WARNING DANGER

Fuel is **VERY** flammable. Use extreme care when mixing, storing or handling.

1. Use a clean rag to remove loose dirt from around fuel cap and empty fuel tank.
2. Use the “fuel line hook” to pull the fuel line and filter from the tank.
3. Remove the filter from the line and install the new filter.



SPARK PLUG

Level 2.

Tools required: T-Wrench, Feeler gauge

Parts Required: REPOWER™ Tune-Up Kit P/N 90074

IMPORTANT

Use only NGK BPM-8Y spark plug (BPMR-8Y in Canada) otherwise severe engine damage may occur.

1. Remove spark plug and check for fouling, worn and rounded center electrode.
2. Clean the plug or replace with a new one. DO NOT sand blast to clean. Remaining sand will damage engine.
3. Adjust spark plug gap by bending outer electrode.
4. Tighten spark plug to 150-170 kg/cm (130-150 in. lb.).

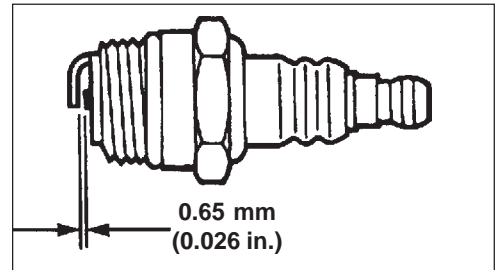
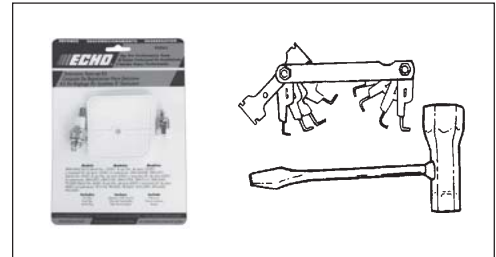

COOLING SYSTEM

Level 2.

Tools required: 25-50 mm (1-2 in.) medium bristle brush, 3 mm Hex Wrench, Cross Head Screwdriver.

Parts Required: None, if you are careful.

IMPORTANT

To maintain proper engine operating temperatures, cooling air must pass freely through the cylinder fin area. This flow of air carries combustion heat away from the engine.

Overheating and engine seizure can occur when:

- Air intakes are blocked, preventing cooling air from reaching the cylinder.
- Dust and grass build up on the outside of the cylinder. This build up insulates the engine and prevents the heat from leaving.

Removal of cooling passage blockages or cleaning of cooling fins is considered "Normal Maintenance". Any failure attributed to lack of maintenance is not warranted.

Cleaning Grill

1. Brush accumulated debris from crankcase intake grill above the fuel tank.

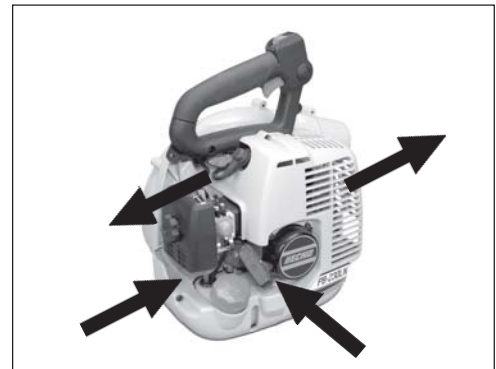
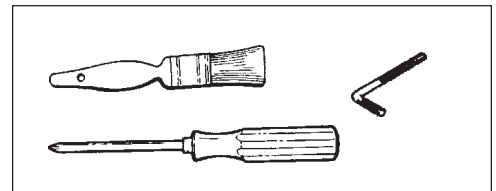

Cleaning Cylinder Fins

1. Remove spark plug lead.
2. Remove two upper 3 mm hex screws at recoil starter.
3. Remove engine cover (four screws), pull cover away from engine. Clean cylinder fins to allow cooling air to pass freely.
4. Loosely reassemble engine cover with four cross head and two hex head screws.
5. Tighten all screws securely.
6. Install spark plug lead.



EXHAUST SYSTEM

Spark Arrestor Screen

Level 2.

Tools required: Cross Head Screwdriver, 3 mm Hex Wrench, 25-50 mm (1-2 in.) medium bristle brush

Parts Required: Spark arrestor screen, Gasket

IMPORTANT

Carbon deposits in muffler will cause a drop in engine output and overheating. Spark arrestor screen must be checked periodically.

1. Remove two upper 3 mm hex screws at recoil starter.
2. Remove four engine cover screws and remove cover from engine. Clean cylinder fins with brush to allow cooling air to pass freely.
3. Remove spark arrestor cover (A), deflector (B), gasket (C), and spark arrestor screen (D) from muffler. Replace screen if plugged with carbon deposits.

NOTE

When cleaning carbon deposit, be careful not to damage the catalytic element inside muffler.

4. Install spark arrestor screen, gaskets, and cover.
5. Loosely reassemble engine cover with four cross head and two hex head screws.
6. Tighten all screws securely.

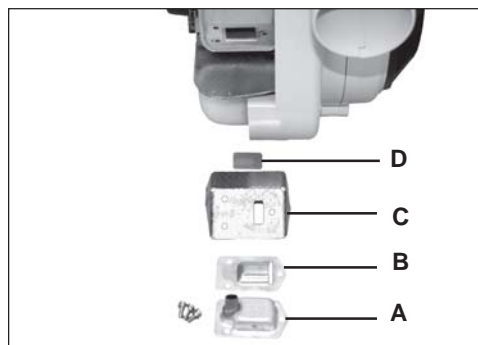
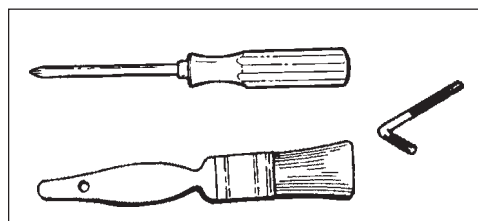

Cylinder Exhaust Port

Level 3.

IMPORTANT

The cylinder exhaust port must be inspected and cleaned of excess carbon every 3 months or 90 hours of operation in order to maintain this engine within the emissions durability period. ECHO strongly recommends that you return your unit to your ECHO dealer for this important maintenance service.

CARBURETOR ADJUSTMENT

Engine Break-In

New engines must be operated a minimum duration of two tanks of fuel break-in before carburetor adjustments can be made. During the break-in period your engine performance will increase and exhaust emissions will stabilize. Idle speed can be adjusted as required.

High Altitude Adjustment

High altitude adjustment is not required for proper operation of this engine.

Level 2.

Tools required: Screwdriver, tachometer (Echo P/N 99051130017)

Parts required: None.

NOTE

Every unit is run at the factory and the carburetor is set in compliance with emission regulations. This carburetor does not have acceleration and high speed adjustment needles.

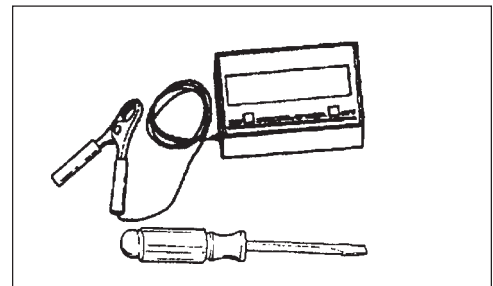

Idle Adjustment

Before adjustment make sure that:

- Air filter is clean and properly installed.
- Spark arrestor screen is free of carbon.
- Blower pipes are installed.

1. Start engine, run at idle for one minute.
2. Complete warm up by running at full throttle for 5 minutes, operating choke twice to clear air from carburetor chambers.
3. Check idle speed and reset if necessary. If a tachometer is available, idle speed screw (A) should be set to the specifications found on Page 20 "Specifications" of this manual. Turn idle screw (A) clockwise to increase idle speed; counter clockwise to decrease idle speed.
4. Accelerate to full throttle for 2-3 seconds to clear excess fuel from engine then return to idle. Accelerate to full throttle to check for smooth transition from idle to full throttle. If engine stops or stalls after full warm up return the unit to your authorized ECHO dealer for repair.

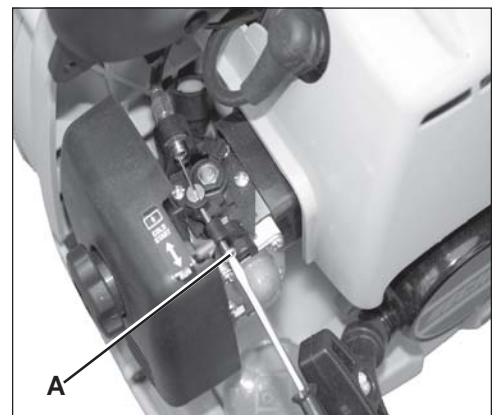

TROUBLESHOOTING

TROUBLESHOOTING CHART				
Problem	Check	Status	Cause	Remedy
Engine cranks - starts hard/ doesn't start	Fuel at carburetor	No fuel at carburetor	Fuel strainer clogged Fuel line clogged Carburetor	Clean or replace Clean or replace See your Echo dealer
	Fuel at cylinder	No fuel at cylinder	Carburetor	See your Echo dealer
		Muffler wet with fuel	Fuel Mixture too rich	Open choke Clean/replace air filter Adjust carburetor See your Echo dealer
	Spark at end of plug wire	No spark	Stop switch off Electrical problem Interlock switch	Turn switch to ON See your Echo dealer See your Echo dealer
	Spark at plug	No spark	Spark gap incorrect Covered with carbon Fouled with fuel Plug defective	Adjust to .65mm (0.026 in.) Clean or replace Clean or replace Replace plug
Engine runs, but dies or does not accelerate properly	Air filter	Air filter dirty	Normal wear	Clean or replace
	Fuel filter	Fuel filter dirty	Contaminants/residues in fuel	Replace
	Fuel vent	Fuel vent plugged	Contaminants/residues in fuel	Clean or replace
	Spark Plug	Plug dirty/worn	Normal wear	Clean and adjust or replace
	Carburetor	Improper adjustment	Vibration	Adjust
	Cooling System	Cooling system dirty/plugged	Extended operation in dirty/dusty locations	Clean
	Spark Arrestor Screen	Spark arrestor screen plugged	Normal wear	Replace
Engine does not crank	N/A	N/A	Internal engine problem	See your Echo dealer
Engine runs, blower doesn't work or is weak/uneven	Blower pipe	Pipe clogged	Build-up of debris	Unclog
		Pipe loose	Vibration	Tighten
		Pipe damaged	Wear/Misuse	Replace

WARNING DANGER

Fuel vapors are **extremely** flammable and may cause fire and/or explosion. **Never** test for ignition spark by grounding spark plug near cylinder plug hole, otherwise serious personal injury may result.

STORAGE

WARNING  **DANGER**

During operation the muffler or catalytic muffler and surrounding cover becomes hot. Always keep exhaust area clear of flammable debris during transportation or when storing, otherwise serious property damage or personal injury may result.

Long Term Storage (Over 30 Days)

Do not store your unit for a prolonged period of time (30 days or longer) without performing protective storage maintenance which includes the following:

1. Store unit in a dry, dust free place, out of the reach of children.

WARNING  **DANGER**

Do not store where fuel fumes may accumulate or reach an open flame or spark.

- | | |
|---|--|
| <ol style="list-style-type: none"> 2. Place the stop switches in the "STOP" position. 3. Remove accumulation of grease, oil, dirt and debris from exterior of unit. 4. Perform all periodic lubrication and services that are required. 5. Tighten all screws and nuts. 6. Drain the fuel tank completely and pull the recoil starter handle several times to remove fuel from the carburetor. | <ol style="list-style-type: none"> 7. Remove the spark plug and pour 7cc (1/4 oz.) of fresh, clean ECHO 2-stroke engine oil into the cylinder through the spark plug hole. <ol style="list-style-type: none"> A. Place a clean cloth over the spark plug hole. B. Pull the recoil starter handle 2-3 times to distribute the oil inside the engine. C. Observe the piston location through the spark plug hole. Pull the recoil handle slowly until the piston reaches the top of its travel and leave it there. 8. Install the spark plug (do not connect ignition cable). 9. Remove blower pipe assembly from unit. |
|---|--|

SPECIFICATIONS

MODEL	PB-231LN Hand Held
Length	335 mm (13.2 in.) (w/o pipes)
Width	235 mm (9.3 in.)
Height	375 mm (14.8 in.)
Weight (dry)	4.6 kg (10.1 lb.)
Engine Type	Air cooled, two-stroke, single cylinder gasoline engine
Displacement	22.8 cc (1.39 cu. in.)
Bore	32.2 mm (1.268 in.)
Stroke	28.0 mm (1.10 in.)
Carburetor	Zama Diaphragm w/primer bulb
Ignition System	Flywheel Magneto, capacitor discharge ignition type
Spark Plug	NGK BPM-8Y Gap 0.65 mm (0.026 in.)
Exhaust System	Spark Arrestor Muffler w / Catalyist
Fuel	Mixed (Gasoline and Two-stroke Oil)
Fuel/Oil Ratio	50:1 ECHO High Performance, two-stroke air cooled engine oil
Gasoline	89 Octane unleaded. DO NOT use fuel containing methyl alcohol, more than 10% ethyl alcohol or 15% MTBE.
Oil	Power Blend™ Premium Universal 2-Stroke Oil
Fuel Tank Capacity	0.6 lit. (20.3 US fl. oz.)
Recoil Starter System	Automatic Recoil Starter Centrifugal Type
Wide Open Throttle Speed (RPM)	6,800-8,800
Idle Speed (RPM)	2,750-3,250
Maximum Air Volume	12.0 m ³ /min. (425) cu. ft./min.)
Maximum Air Speed w/pipes (MPH)	241.4 KM/H (150 mph)
Sound Level at 50 ft. dB(A) scale per ANSI B175.2 ----	65 dB(A)

NOTES

NOTES

NOTES

SERVICING INFORMATION

PARTS/SERIAL NUMBER

Genuine ECHO Parts and ECHO REPOWER™ Parts and Assemblies for your ECHO products are available only from an Authorized ECHO Dealer. When you do need to buy parts **always** have the Model Number and Serial Number of the unit with you. You can find these numbers on the engine housing. For future reference, write them in the space provided below.

Model No. _____ SN. _____

SERVICE

Service of this product during the warranty period must be performed by an Authorized ECHO Service Dealer. For the name and address of the Authorized ECHO Service Dealer nearest you, ask your retailer or call: 1-800-432-ECHO (3246). Dealer information is also available on our Web Site. When presenting your unit for Warranty service/repairs, proof of purchase is required.

ECHO CONSUMER PRODUCT SUPPORT

If you require assistance or have questions concerning the application, operation or maintenance of this product you may call the ECHO Consumer Product Support Department at 1-800-673-1558 from 8:30 am to 4:30 pm (Central Standard Time) Monday through Friday. Before calling, please know the model and serial number of your unit to help your Consumer Product Support Representative.

WARRANTY REGISTRATION

You may register your Echo equipment using the warranty registration card or register on-line at www.echo-usa.com. Registering provides a direct link between you and ECHO if we find it necessary to contact you.

ADDITIONAL OR REPLACEMENT MANUALS

Safety Manuals in English/Spanish or English/French are available, free of charge, from your ECHO dealer or at www.echo-usa.com.

Operator's and Parts Manuals are available by:

- Downloading free from www.echo-usa.com
- Purchasing from your Echo Dealer.
- Manuals are available by sending a written request stating the model number and serial number of your Echo unit, part number of the manual, your name and address, and mail to the address below.

Safety Videos are available from your Echo dealer. A \$5.00 shipping charge will be required for each video.

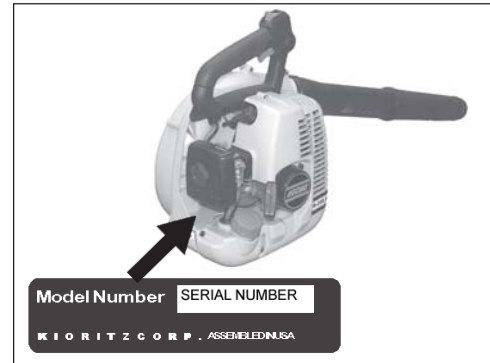

DEALER?

Call
1-800-432-ECHO
or
www.echo-usa.com

CONSUMER PRODUCT SUPPORT

1-800-673-1558
8:30 - 4:30 Mon - Fri C.S.T.

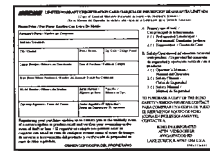

ECHO®

ECHO, INCORPORATED

400 OAKWOOD ROAD

LAKE ZURICH, IL 60047-1564

www.echo-usa.com

06001001/06999999