

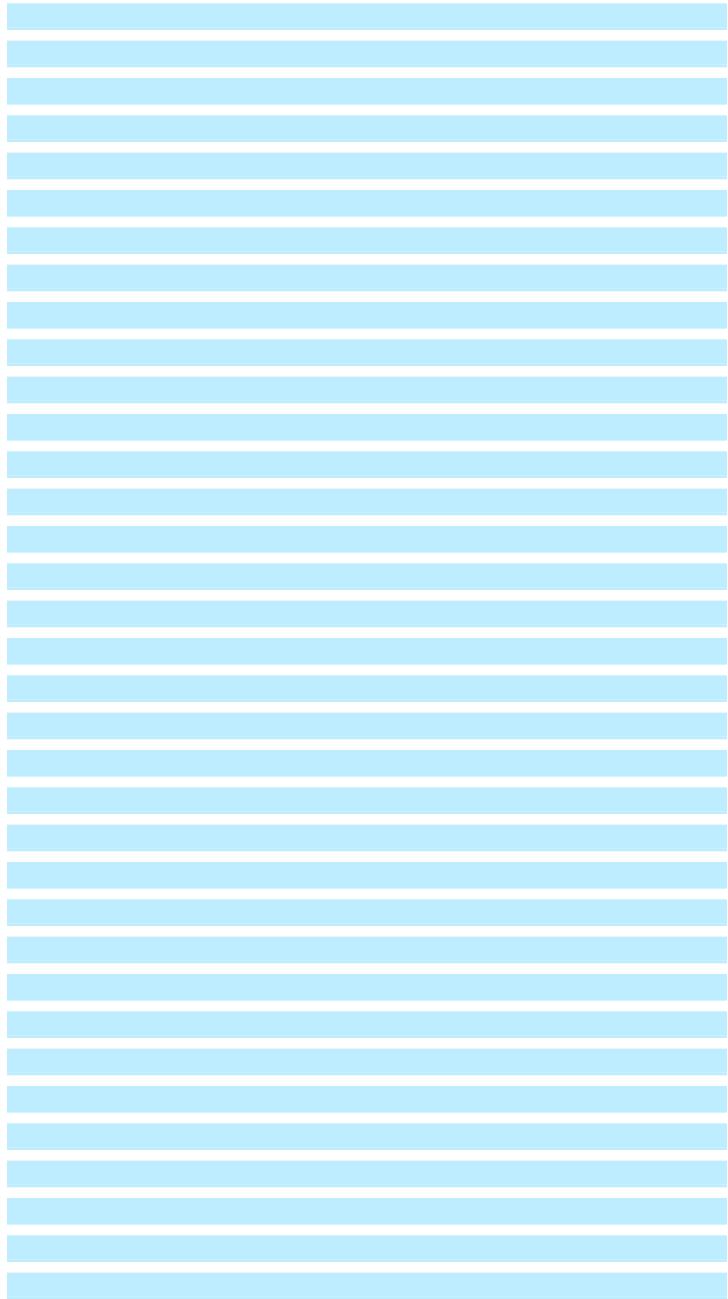

Accessories for ECHO products can be found at:
Los accesorios para los productos ECHO se pueden encontrar en:
<http://www.echo-usa.com/Products/Accessories>



PARTS CATALOG
LISTA DE PIEZAS

PE-2620S Edger
PE-2620S Orilladora

25.4 cc

SERIAL NUMBER
NÚMERO DE SERIE

U89912001001 - U89912999999



ECHO Incorporated

400 Oakwood Road, Lake Zurich, Illinois 60047

WWW.ECHO-USA.COM

Table of Contents

Tabla de Contenido

 **PE-2620S**
Edger / Orilladora

Engine Cover	3	Handle - Support	17
Cubierta del Motor		Mango de soporte	
Engine	4	Gear Case	18
Motor		Caja de Engranajes	
Engine	5	Edger Shield	19
Motor		Protector para Orilladora	
Carburetor	6	Labels	20
Carburador		Etiquetas	
Carburetor	7	Tools	21
Carburador		Herramientas	
Intake	8	Maintenance Kits	21
Admisión		Kits de Mantenimiento	
Exhaust	9	Bulk Pipe	22
Escape		Tubo al por mayor	
Ignition S/N U89912001001 - U89912007000 ..	10	Bulk Starter Rope	22
Encendido S/N U89912001001 - U89912007000		Cuerda del arrancador al por mayor	
Ignition S/N U89912007001 - U89912999999 ..	11		
Encendido S/N U89912007001 - U89912999999			
Starter	12		
Arrancador			
Fuel System	13		
Sistema de combustible			
Fan Case	14		
Carcasa del Ventilador			
Main Pipe	15		
Tubo Principle			
Control Handle	16		
Mango de Control			

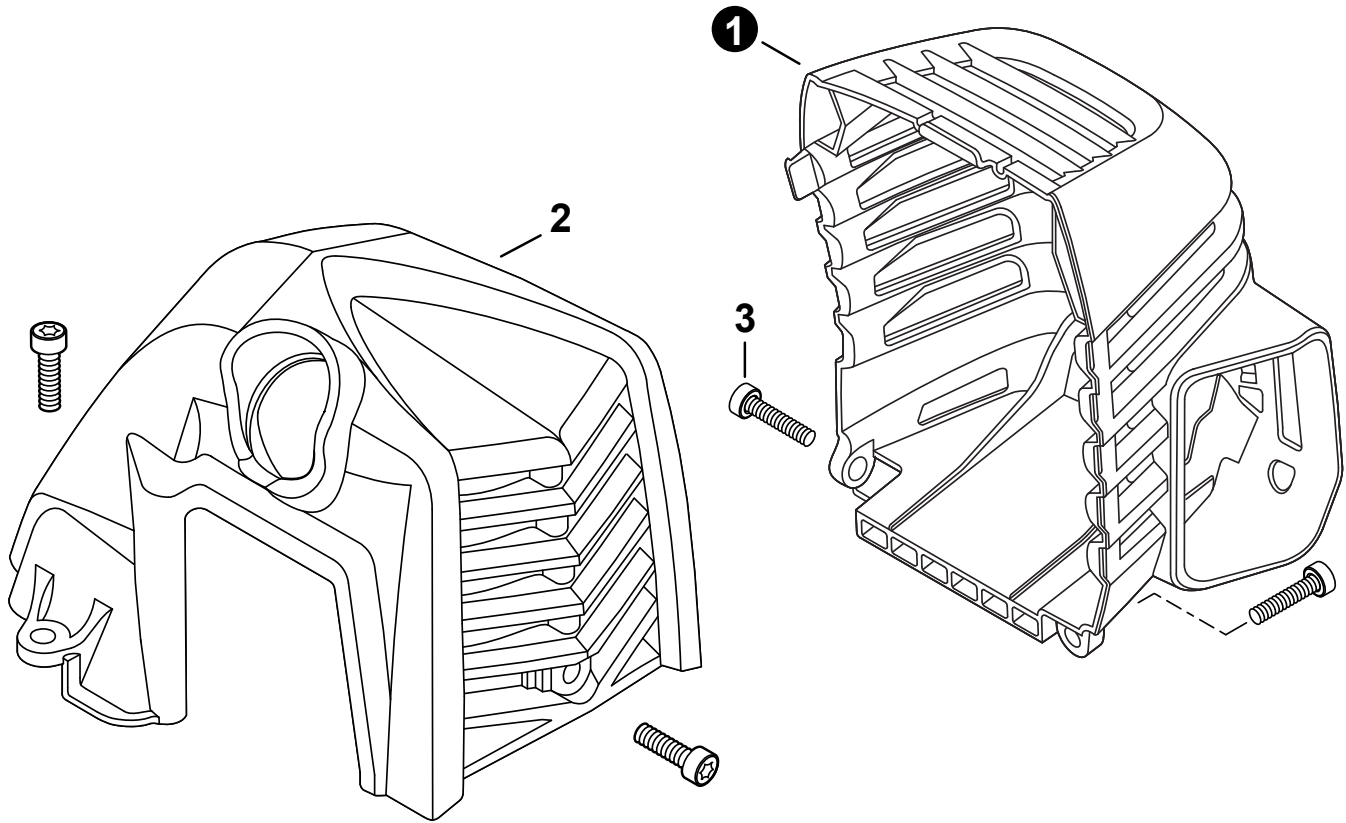

NO.	PART NUMBER	QTY.	DESCRIPTION	DESCRIPCIÓN
1	A320001201	1	COVER, MUFFLER	CUBIERTA DEL SILENCIADOR
2	A160003281	1	COVER, ENGINE	CUBIERTA DE MOTOR
3	V835000010	4	BOLT, TORX 5x12	PERNO TORX 5x12

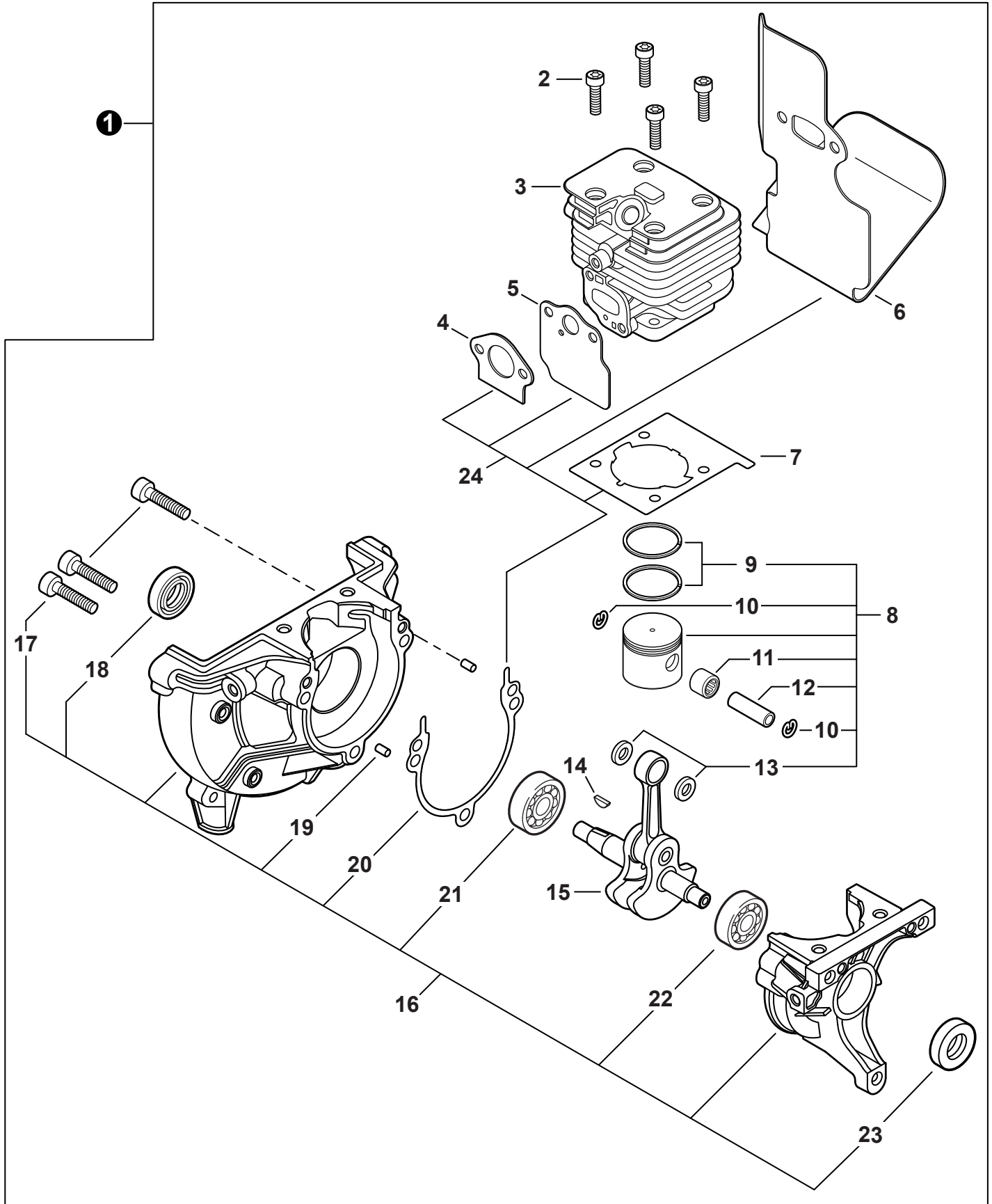

NO.	PART NUMBER	QTY.	DESCRIPTION	DESCRIPCIÓN
1	SB1118	1	SHORT BLOCK	BLOQUE CORTO
2	V805000210	4	+BOLT, TORX 5x20	+PERNO TORX 5x20
3	A130002330	1	+CYLINDER	+CILINDRO
4	V103001900	1	+GASKET, INTAKE	+EMPAQUETADURA DE ADMISIÓN
5	V103001890	1	+HEAT SHIELD, INTAKE	+PROTECTOR TÉRMICO DEL ADMISIÓN
6	V104002310	1	+HEAT SHIELD, EXHAUST	+PROTECTOR TÉRMICO DEL ESCAPE
7	V100000840	1	+GASKET, CYLINDER	+EMPAQUETADURA DE CILINDRO
8	P021050840	1	+PISTON KIT	+JUEGO DE PISTÓN
9	A101000010	2	++RING, PISTON	++ANILLO DEL PISTÓN
10	10001503931	2	++RING, SNAP	++ANILLO RETENEDOR
11	V554000020	1	++BEARING, NEEDLE 9	++COJINETE DE AGUJAS 9
12	10001335430	1	++PIN, PISTON	++PASADOR DEL PISTÓN
13	10001453630	2	++WASHER, THRUST	++ARANDELA DE EMPUJE
14	10014212330	1	+KEY, WOODRUFF	+CHAVETA WOODRUFF
15	A011001660	1	+CRANKSHAFT ASSY	+MONTAJE DE CIGÜEÑAL
16	P100014630	1	+CRANKCASE KIT	+JUEGO DE CÁRTER
17	V805000220	3	++BOLT, TORX 5x25	++PERNO TORX 5x25
18	10021242031	1	++SEAL, OIL 12	++SELLO DE ACEITE 12
19	90033040080	2	++PIN, LOCATING 4x8	++PASADOR DE POSICIONAMIENTO 4x8
20	V102000300	1	++GASKET, CRANKCASE	++EMPAQUETADURA DE CÁRTER
21	9409536001	1	++BEARING, BALL	++COJINETE DE BOLAS
22	9409536000	1	++BEARING, BALL	++COJINETE DE BOLAS
23	V503000040	1	++SEAL, OIL 10	++SELLO DE ACEITE 10
24	P021051540	1	GASKET KIT: ENGINE, INTAKE, EXHAUST	JUEGO DE EMPAQUETADURA - MOTOR, ADMISIÓN, ESCAPE

NO.	PART NUMBER	QTY.	DESCRIPTION	DESCRIPCIÓN
1	A021005600	1	CARBURETOR - WYG-23A	CARBURADOR - WYG-23A
2	P003004560	7	+SCREW	+TORNILLO
3	P021054860	1	+SWIVEL KIT	+KIT DE PIVOTE
4	12314954230	1	+WASHER	+ARANDELA
5	12317307930	1	+E-RING	+RETENEDOR TIPO "E"
6	P003006620	1	+THROTTLE VALVE ASSY	+MONTAJE DE VÁLVULA DEL ACELERADOR
7	P003004480	1	++O-RING	++JUNTA TÓRICA
8	P003005880	1	+NEEDLE, MIXTURE	+AGUJA DE REGULACION
9	P003006120	1	+BODY ASSY, PUMP	+MONTAJE DE CUERPO DE BOMBA
10	A263000020	1	+BULB, PURGE	+BULBO DE PURGA
11	P003006500	1	+COVER, FUEL PUMP	+TAPA DE LA BOMBA DE COMBUSTIBLE
12	P003004570	4	+SCREW	+TORNILLO
13	12314203930	1	+COVER, METERING DIAPHRAGM	+TAPA DE DIAFRAGMA DE MEDICIÓN
14	P003005860	1	+SCREW	+TORNILLO
15	P003005870	1	+SPRING	+RESORTE
16	P003005940	1	+REPAIR KIT, CARBURETOR	+JUEGO DE REPARACIÓN DE CARBURADOR
17		1	++GASKET, FUEL PUMP	++EMPAQUETADURA DE LA BOMBA DE COMBUSTIBLE
18		1	++DIAPHRAGM, FUEL PUMP	++DIAFRAGMA DE LA BOMBA DE COMBUSTIBLE
19		1	++SCREEN, FUEL INLET	++MALLA FILTRADORA
20		1	++LEVER, METERING	++PALANCA DE MEDICIÓN
21		1	++PIN, METERING LEVER	++PASADOR DE PALANCA DE MEDICIÓN
22		1	++VALVE, INLET NEEDLE	++VÁLVULA REGULADORA
23		1	++GASKET, METERING DIAPHRAGM	++EMPAQUETADURA DE DIAFRAGMA DE MEDICIÓN
24		1	++DIAPHRAGM, METERING	++DIAFRAGMA DE MEDICIÓN

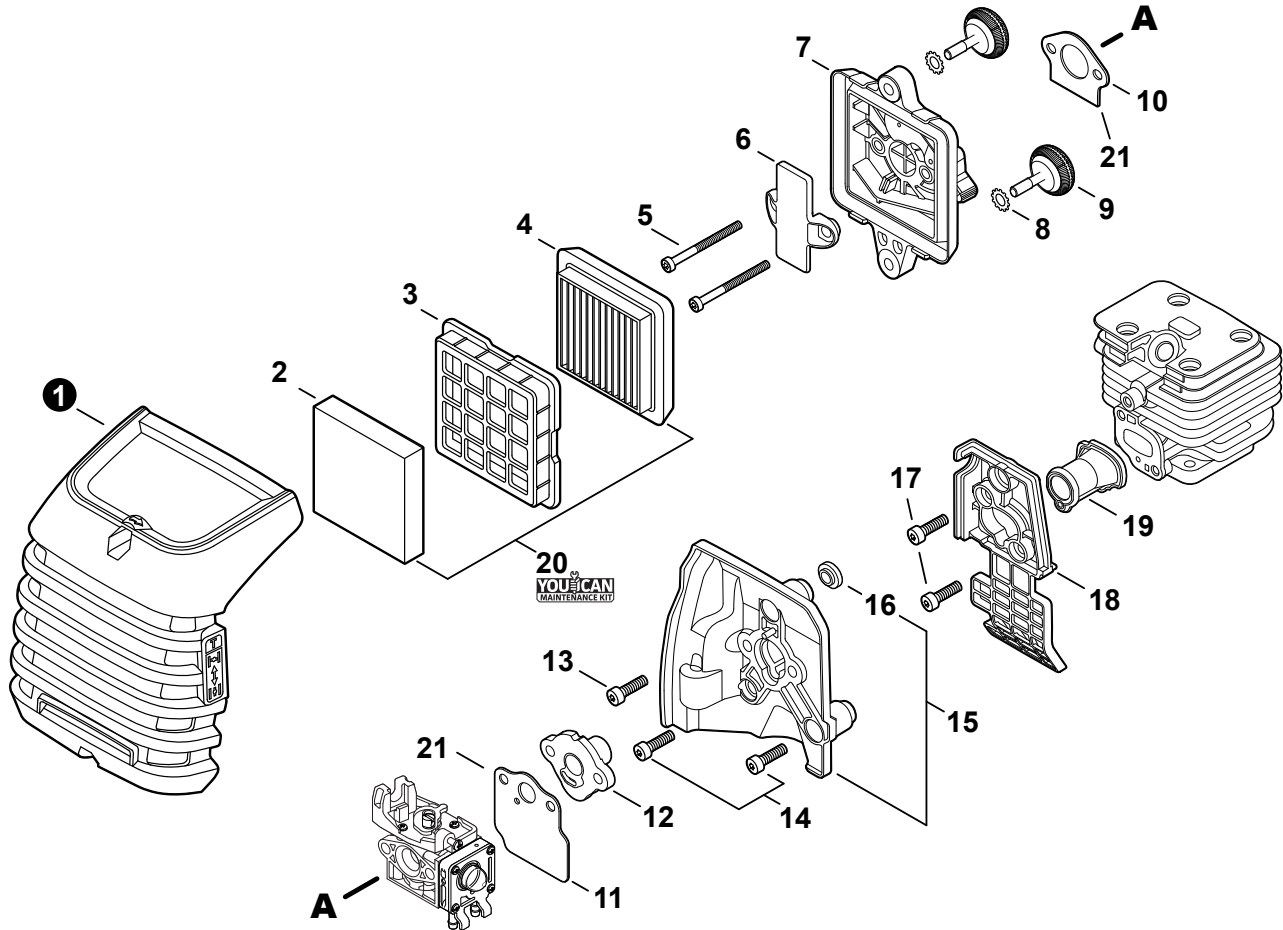

NO.	PART NUMBER	QTY.	DESCRIPTION	DESCRIPCIÓN
1	A232001891	1	COVER, AIR FILTER	CUBIERTA DEL FILTRO DE AIRE
2	A226002040	1	PRE-FILTER, FOAM	PRÉ-FILTRO DE ESPUMA
3	A227000050	1	RETAINER, PRE-FILTER	RETENEDOR, PRE-FILTRO
4	A226002030	1	FILTER, AIR	FILTRO DE AIRE
5	V805000430	2	BOLT, TORX 5x60	PERNO TORX 5x60
6	A244000360	1	PLATE, PREVENT	PLACA DE PREVENCIÓN
7	P021050880	1	CASE, AIR FILTER	CAJA DEL FILTRO DE AIRE
8	V340000210	2	WASHER, LOCK	ARANDELA DE SEGURIDAD
9	V299000640	2	THUMBSCREW	TORNILLO DE OREJETAS
10	V103001900	1	GASKET, INTAKE	EMPAQUETADURA DE ADMISIÓN
11	V103001890	1	HEAT SHIELD, INTAKE	PROTECTOR TÉRMICO DEL ADMISIÓN
12	A209001000	1	BOOT, INSULATOR PLATE	BOTA, PLACA AISLANTE
13	V855000000	1	BOLT, TORX 5x20	PERNO TORX 5x20
14	V805000150	2	BOLT, TORX 5x16	PERNO TORX 5x16
15	A209001010	1	PLATE, INSULATOR	PLACA AISLANTE
16	V353000020	1	+COLLAR 5	+COLLAR 5
17	V253001020	2	SCREW 5x16	TORNILLO 5x16
18	A206000040	1	HOLDER, BELLOWS	SOPORTE DE FUELLE
19	A202000300	1	BELLOWS, INTAKE	FUELLE DE ADMISIÓN
20	90181Y	1	TUNE-UP KIT - YOU CAN™	JUEGO DE PUESTA A PUNTO - YOU CAN™
21	P021051540	1	GASKET KIT: ENGINE, INTAKE, EXHAUST	JUEGO DE EMPAQUETADURA - MOTOR, ADMISIÓN, ESCAPE

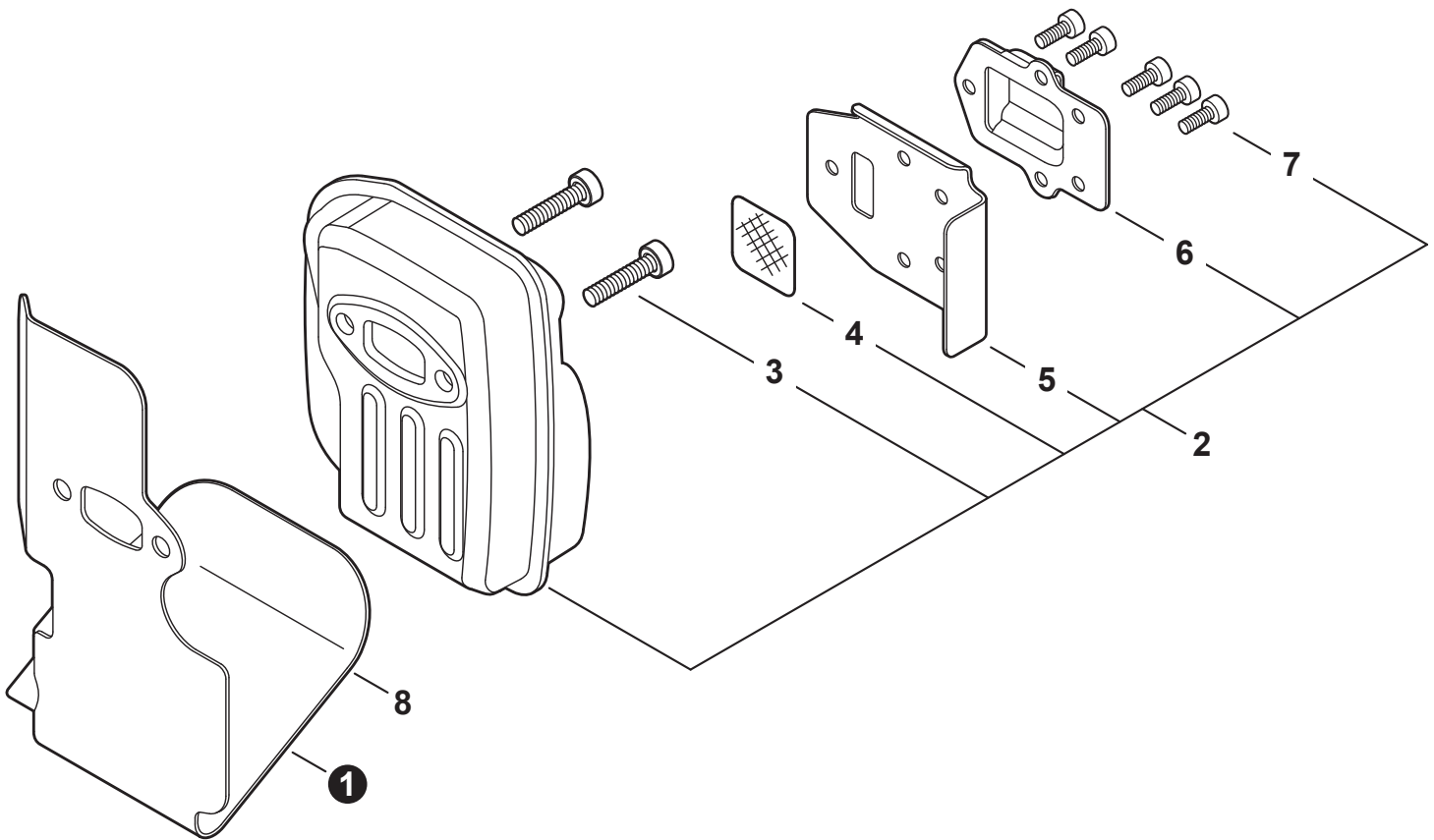

NO.	PART NUMBER	QTY.	DESCRIPTION	DESCRIPCIÓN
1	V104002310	1	HEAT SHIELD, EXHAUST	PROTECTOR TÉRMICO DEL ESCAPE
2	P021050901	1	MUFFLER ASSY	MONTAJE DE SILENCIADOR
3	V805000250	2	+BOLT, TORX 5x16	+PERNO TORX 5x16
4	14586240630	1	+SCREEN, SPARK ARRESTER	+SUPRESOR DE CHISPAS
5	V104002300	1	+GASKET, EXHAUST	+EMPAQUETADURA DE ESCAPE
6	A313002060	1	+GUIDE, EXHAUST	+GUÍA DE ESCAPE
7	V804000030	5	+BOLT, TORX 4x8	+PERNO TORX 4x8
8	P021051540	1	GASKET KIT: ENGINE, INTAKE, EXHAUST	JUEGO DE EMPAQUETADURA - MOTOR, ADMISIÓN, ESCAPE

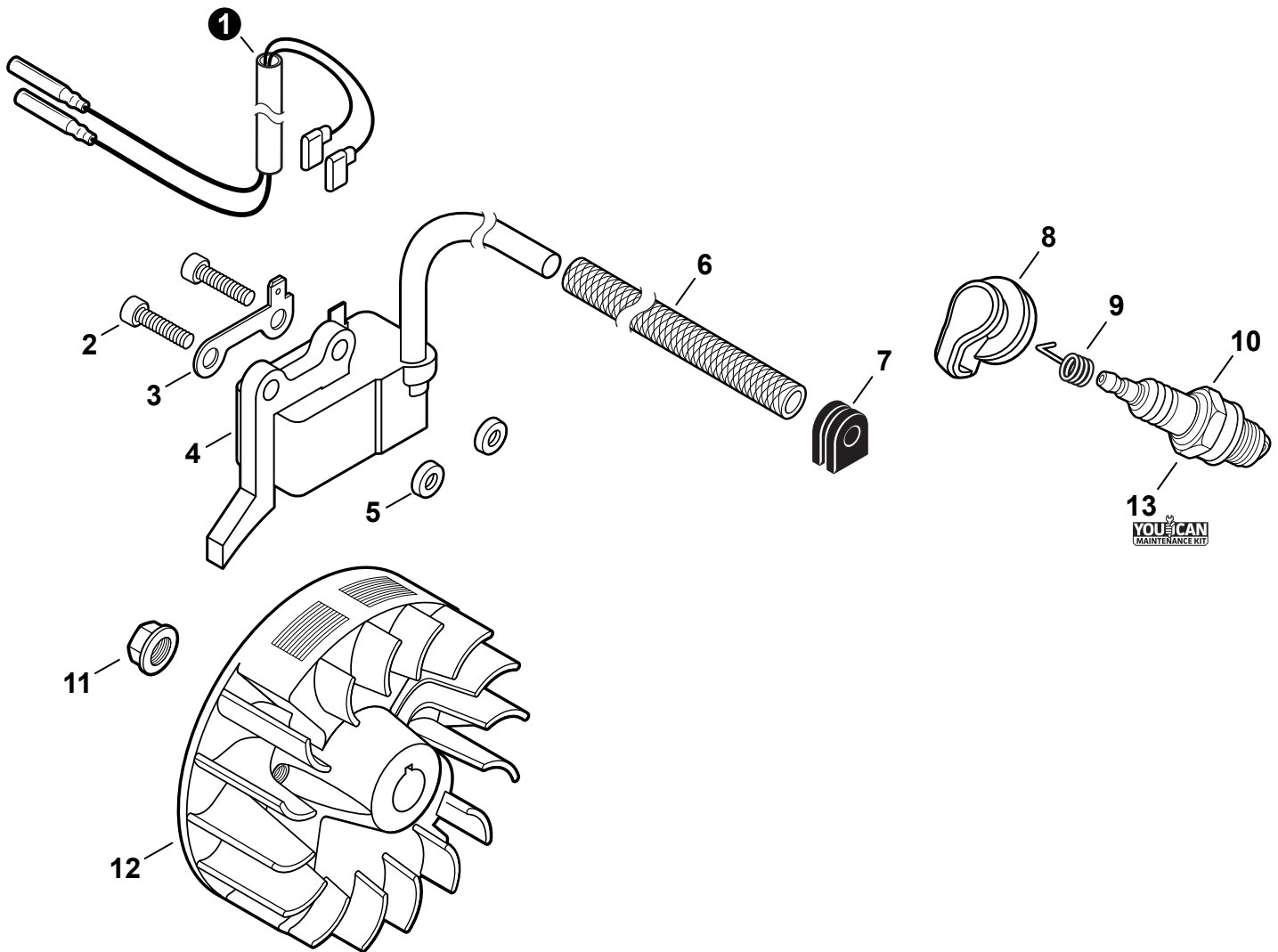

NO.	PART NUMBER	QTY.	DESCRIPTION	DESCRIPCIÓN
1	V485002881	1	LEAD SET - IGNITION	JUEGO DE CABLE DE ENCENDIDO
2	V805000210	2	BOLT, TORX 5x20	PERNO TORX 5x20
3	C152001030	1	CONNECTOR	CONECTOR
4	A411001791	1	COIL, IGNITION	BOBINA DE ENCENDIDO
5	V323000070	2	SPACER 5	ESPACIADOR 5
6	V475007540	1	TUBE, INSULATOR	TUBO AISLANTE
7	15611004920	1	GROMMET	OJAL
8	A427000221	1	CAP, SPARK PLUG	TAPA DE BUJÍA
9	A426000010	1	TERMINAL, SPARK PLUG	TERMINAL DE BUJÍA
10	A425000060	1	SPARK PLUG - CMR7H	BUJÍA - CMR7H
11	90051500008	1	NUT, FLANGE M8	TUERCA-BRIDA M8
12	A409001320	1	FLYWHEEL	VOLANTE
13	90181Y	1	TUNE-UP KIT - YOUCAN™	JUEGO DE PUESTA A PUNTO - YOUCAN™

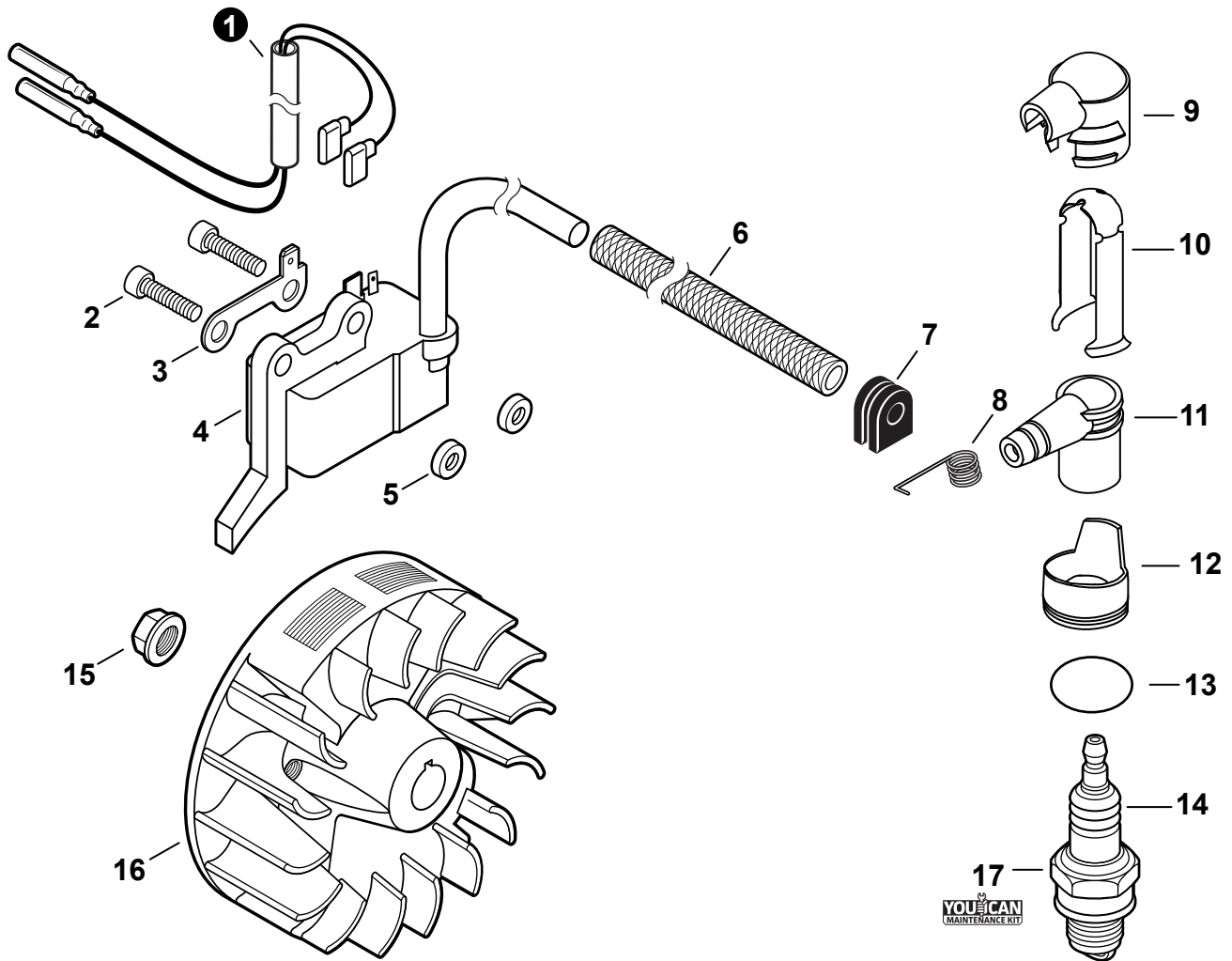

NO.	PART NUMBER	QTY.	DESCRIPTION	DESCRIPCIÓN
1	V485002881	1	LEAD SET - IGNITION	JUEGO DE CABLE DE ENCENDIDO
2	V805000210	2	BOLT, TORX 5x20	PERNO TORX 5x20
3	C152001030	1	CONNECTOR	CONECTOR
4	A411002270	1	COIL, IGNITION	BOBINA DE ENCENDIDO
5	V323000070	2	SPACER 5	ESPACIADOR 5
6	V475007540	1	TUBE, INSULATOR	TUBO AISLANTE
7	15611004920	1	GROMMET	OJAL
8	15901103432	1	TERMINAL, SPARK PLUG	TERMINAL DE BUJÍA
9	A429000110	1	COVER, CAP	TAPA
10	V151000170	1	SHIELD, SPARK PLUG	PROTECTOR DE BUJÍA
11	A427000090	1	CAP, SPARK PLUG	TAPA DE BUJÍA
12	J473000120	1	PIECE, COVER	PIEZA, CUBIERTA
13	90072000022	1	O-RING 22	JUNTA TÓRICA 22
14	A425000060	1	SPARK PLUG - CMR7H	BUJÍA - CMR7H
15	90051500008	1	NUT, FLANGE M8	TUERCA-BRIDA M8
16	A409001320	1	FLYWHEEL	VOLANTE
17	90181Y	1	TUNE-UP KIT - YOUCAN™	JUEGO DE PUESTA A PUNTO - YOUCAN™

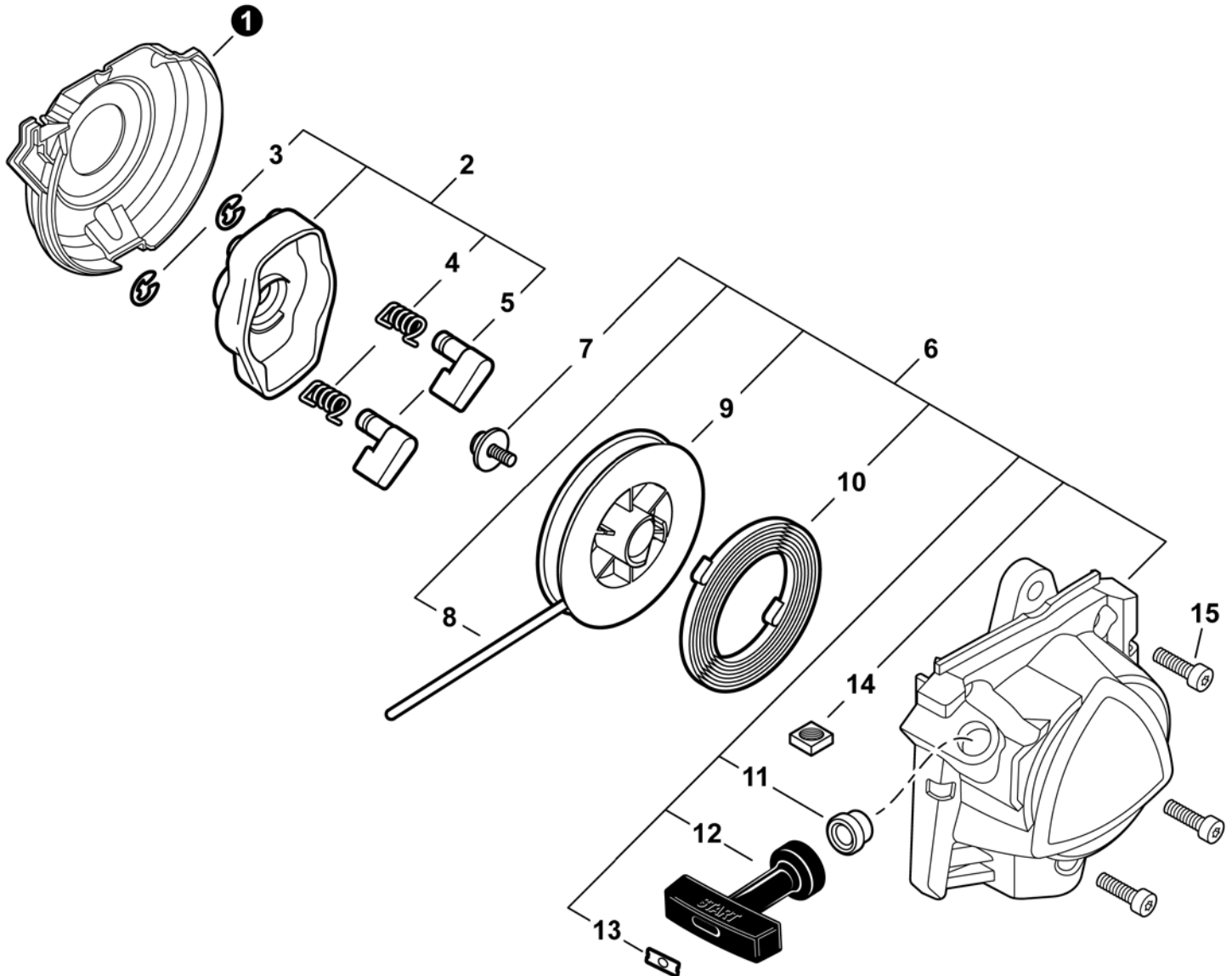

NO.	PART NUMBER	QTY.	DESCRIPTION	DESCRIPCIÓN
1	A127000470	1	COVER, DUST	CUBIERTA ANTIPOLVO
2	A052000030	1	PAWL ASSY, STARTER	MONTAJE DE TRINQUETE
3	P022002100	2	+E-RING 4	+RETENEDOR TIPO "E" 4
4	17723440630	2	+SPRING, RETURN	+RESORTE DE RETORNO
5	P022003120	2	+PAWL, STARTER	+TRINQUETE
6	A051003210	1	STARTER ASSY, RECOIL	MONTAJE DE ARRANCADOR AUTORRETRÁCTIL
7	17723644330	1	+SCREW	+TORNILLO
8	P022043690	1	+ROPE, STARTER	+CUERDA DEL ARRANCADOR
9	17721540630	1	+REEL, ROPE	+CARRETE DE CUERDA
10	17722040630	1	+SPRING, RECOIL	+RESORTE RECULAR
11	17722742030	1	+GUIDE, ROPE	+GUÍA DE CUERDA
12	17722827030	1	+GRIP, STARTER	+AGARRE DEL ARRANCADOR
13	P022037670	1	+RETAINER, ROPE	+RETENEDOR DE CUERDA
14	90056550005	2	+NUT - 5 - SQUARE	+TUERCA - 5 - CUADR
15	V805000140	3	BOLT, TORX 5x12	PERNO TORX 5x12

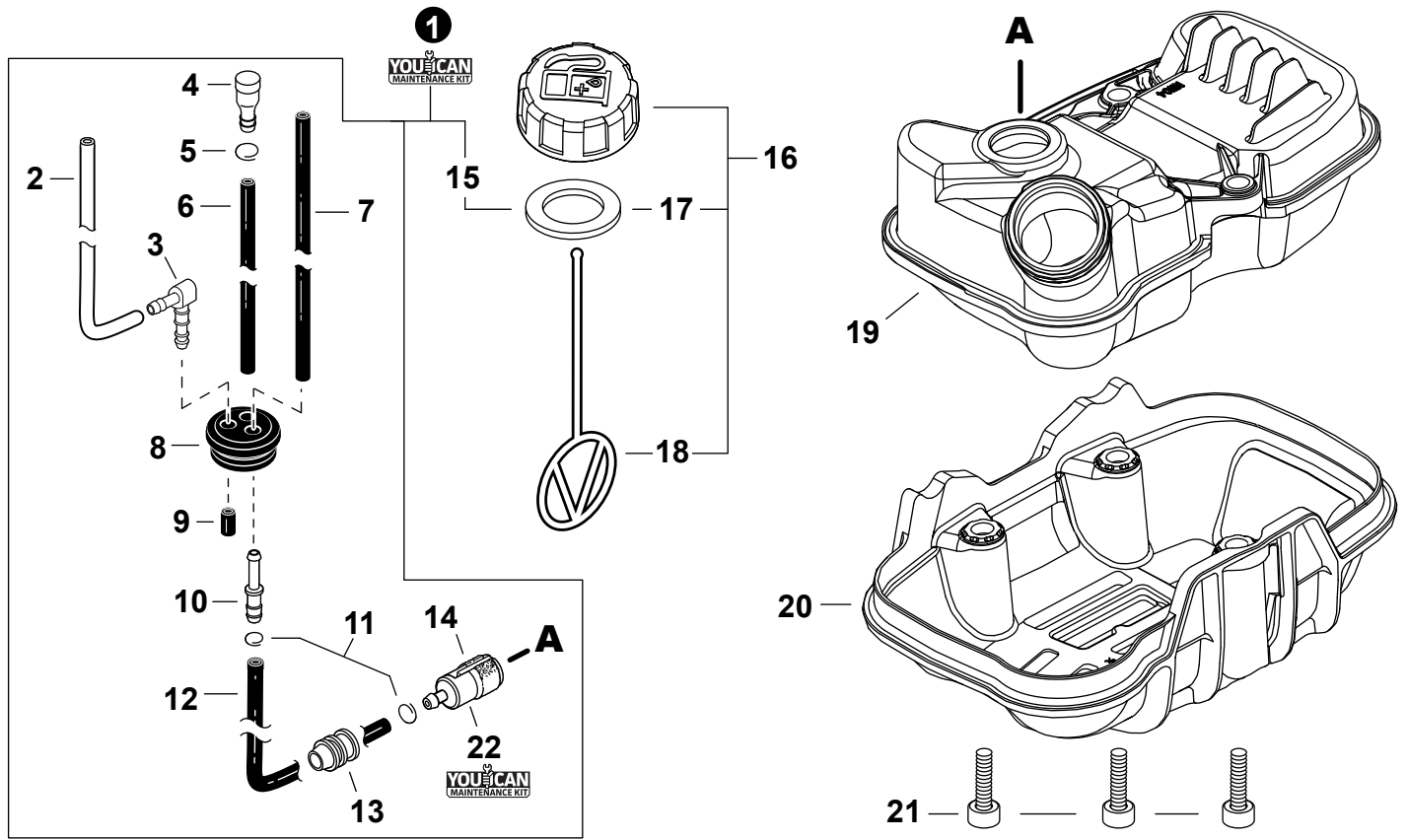

NO.	PART NUMBER	QTY.	DESCRIPTION	DESCRIPCIÓN
1	90261Y	1	FUEL SYSTEM KIT - YOUCAN™	KIT DEL SISTEMA DE COMBUSTIBLE - YOUCAN™
2	13201040830	1	+PIPE, FUEL 3x6x75 CLEAR	+TUBO DE COMBUSTIBLE 3x6x75 TRANSPARENTE
3	V186000500	1	+CONNECTOR, PIPE	+CONECTOR DE TUBO
4	A356000230	1	+VENT ASSY	+VÁLVULA DE RESPIRADERO
5	V490001230	1	+CLIP 6.5 MM	+SUJETADOR 6.5 MM
6	13201006531	1	+PIPE, FUEL 3x6x85 BLACK	+TUBO DE COMBUSTIBLE 3x6x85 NEGRO
7	V471005640	1	+PIPE, FUEL 3x5.5x80 BLACK	+TUBO DE COMBUSTIBLE 3x5.5x80 NEGRO
8	13211555931	1	+GROMMET, FUEL	+OJAL DE COMBUSTIBLE
9	10092735830	1	+PIPE 3x7x10 - BLACK	+TUBO 3x7x10 NEGRO
10	V186000520	1	+CONNECTOR, PIPE 5x3.5	+CONECTOR DE TUBO 5x3.5
11	V490001240	2	+CLIP 6	+SUJETADOR 6
12	V471003661	1	+PIPE, FUEL 3x5x115 BLACK	+TUBO DE COMBUSTIBLE 3x5x115 NEGRO
13	A413000190	1	+BOOT	+BOTA
14	A369000470	1	+FILTER, FUEL	+FILTRO DE COMBUSTIBLE
15	V107000230	1	+GASKET, FUEL CAP	+EMPAQUETADURA DE TAPA DE COMBUSTIBLE
16	P100014430	1	CAP ASSY, FUEL	MONTAJE DE TAPA DE COMBUSTIBLE
17	V107000230	1	+GASKET, FUEL CAP	+EMPAQUETADURA DE TAPA DE COMBUSTIBLE
18	A365000060	1	+CONNECTOR, CAP L= 123	+CONECTOR DE TAPA L= 123
19	A350002811	1	TANK, FUEL	TANQUE DE COMBUSTIBLE
20	A175000460	1	GUARD, FUEL TANK	PROTECTOR, TANQUE DE COMBUSTIBLE
21	V253000990	3	BOLT 5x20	PERNO 5x20
22	90181Y	1	TUNE-UP KIT - YOUCAN™	JUEGO DE PUESTA A PUNTO - YOUCAN™

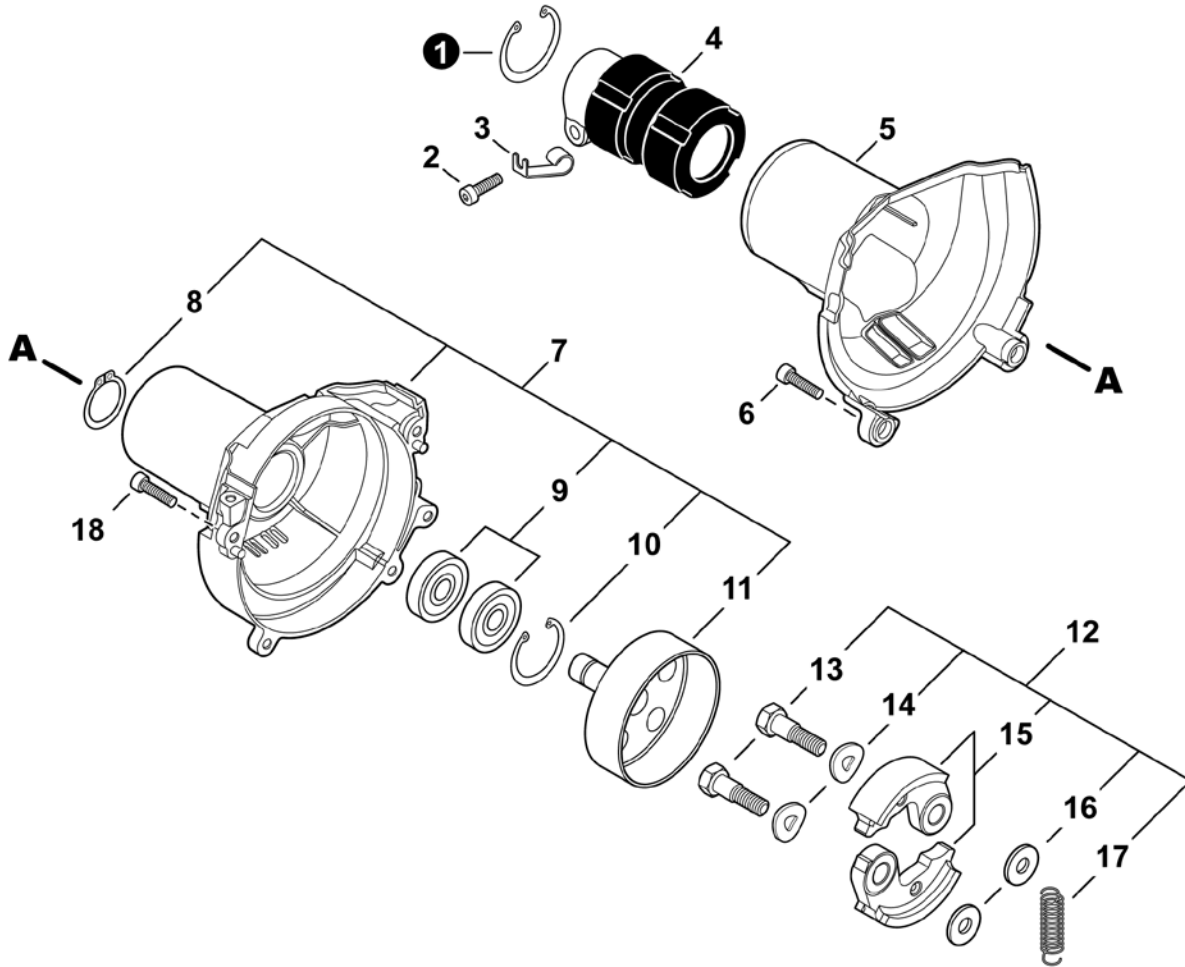

NO.	PART NUMBER	QTY.	DESCRIPTION	DESCRIPCIÓN
1	90070200042	1	RING, SNAP 42	ANILLO RETENEDOR 42
2	V805000170	1	BOLT, TORX 5x25	PERNO TORX 5x25
3	V490001520	1	CLIP, CABLE	SUJETADOR DE CABLE
4	A575000640	1	HOLDER, MAIN PIPE	SUJETADOR DE TUBO PRINCIPAL
5	A413000080	1	PROTECTOR, FAN COVER	PROTECTOR DEL CUBIERTA DE VENTILADOR
6	V805000160	2	BOLT, TORX 5x20	PERNO TORX 5x20
7	P021054130	1	COVER ASSY, FAN	MONTAJE DE CUBIERTA DE VENTILADOR
8	90070100012	1	+RING, SNAP 12	+ANILLO RETENEDOR 12
9	9406106001	2	+BEARING, BALL 6001	+COJINETE DE BOLAS 6001
10	90070200028	1	+RING, SNAP 28	+ANILLO RETENEDOR 28
11	A556001760	1	+DRUM, CLUTCH	+TAMBOR DE EMBRAGUE
12	P021050860	1	CLUTCH ASSY	MONTAJE DE EMBRAGUE
13	17504656030	2	+BOLT, CLUTCH 8x7.9xM6	+PERNO DE EMBRAGUE 8x7.9xM6
14	17504956030	2	+WASHER, SPRING 8.5x16x0.5	+ARANDELA DE PRESION 8.5x16x0.5
15	A553000190	2	+SHOE, CLUTCH	+ZAPATA DE EMBRAGUE
16	17504805530	2	+WASHER 6.2x19x1.0	+ARANDELA 6.2x19x1.0
17	V451001390	1	+SPRING, CLUTCH	+RESORTE DEL EMBRAGUE
18	V805000150	2	BOLT, TORX 5x16	PERNO TORX 5x16

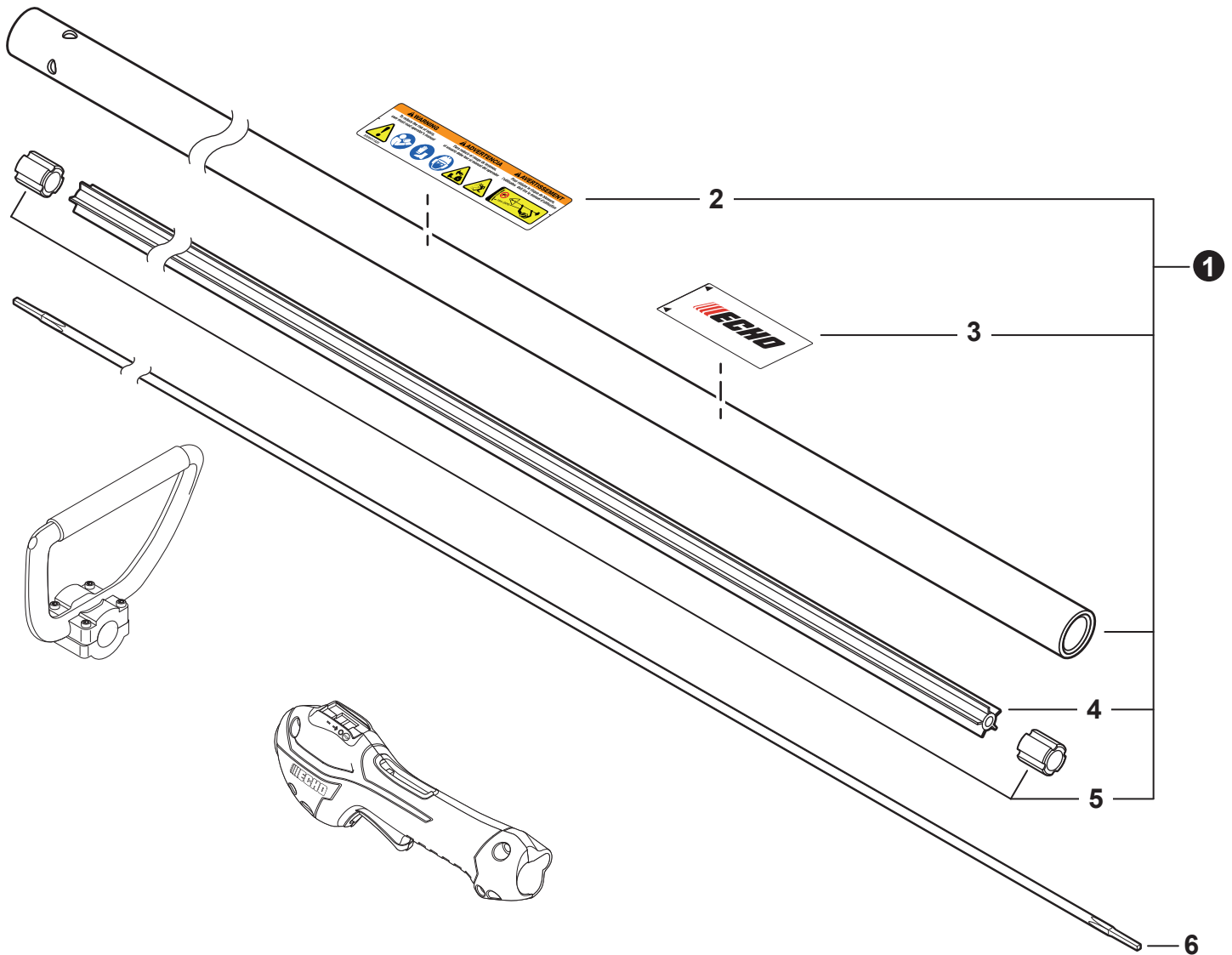

NO.	PART NUMBER	QTY.	DESCRIPTION	DESCRIPCIÓN
1	C050003550	1	MAIN PIPE ASSY	MONTAJE DE TUBO PRINCIPAL
2	X505011920	1	+LABEL - CAUTION ISO	+ETIQUETA DE PRECAUCIÓN ISO
3	X505012260	1	+LABEL - HANDLE LOCATION	+ETIQUETA - UBICACIÓN DEL MANGO
4	C507000430	1	+LINER, FLEXIBLE	+FORRO FLEXIBLE
5	61024644730	1	+STOPPER	+RETENEDOR
6	C506000630	1	DRIVESHAFT - FLEXIBLE	EJE DE MANDO - FLEXIBLE

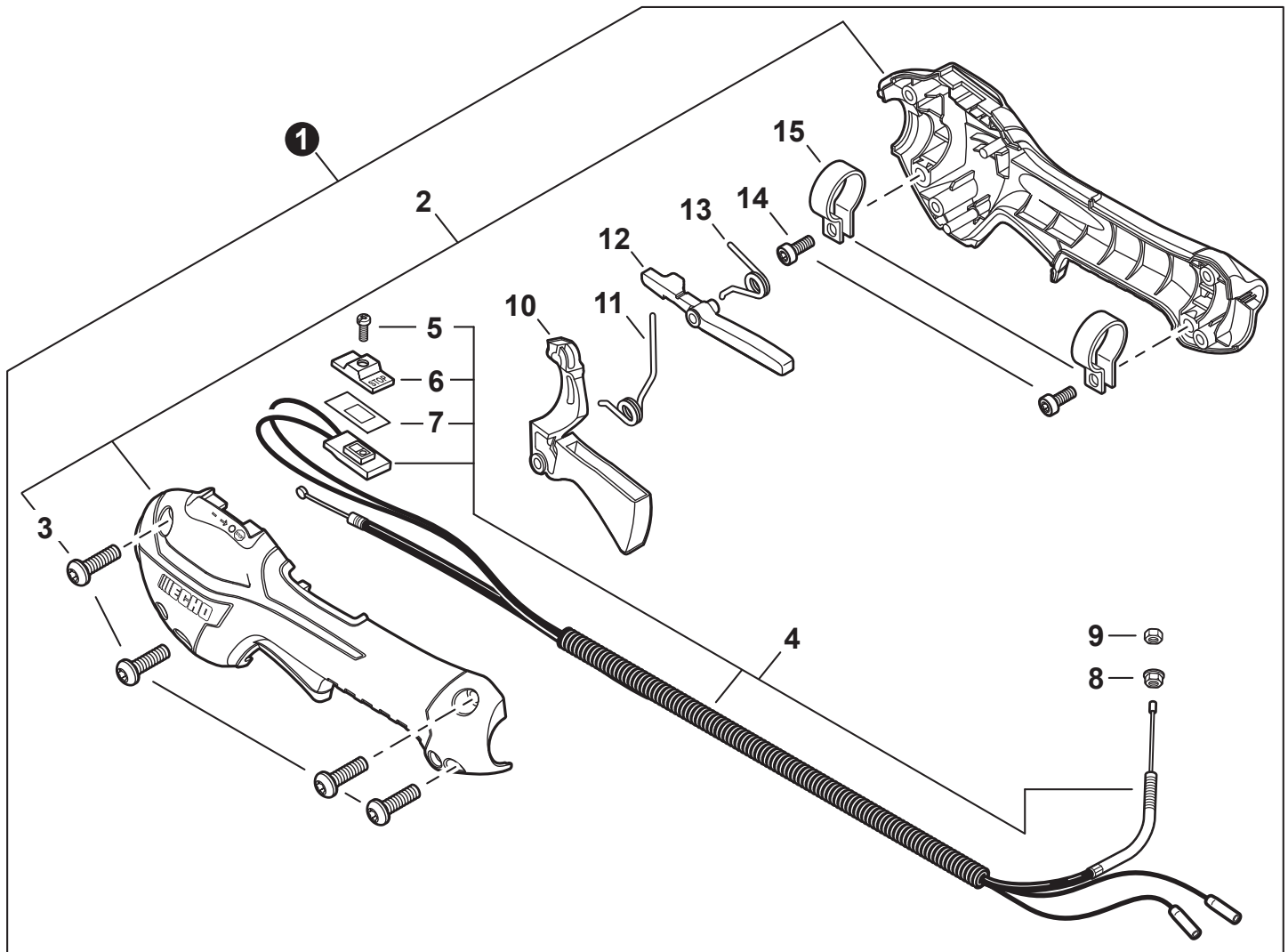

NO.	PART NUMBER	QTY.	DESCRIPTION	DESCRIPCIÓN
1	P021052270	1	CONTROL HANDLE ASSY	MONTAJE DE MANGO DE CONTROL
2	P021044371	1	+CONTROL HANDLE KIT	+JUEGO DE MANGO DE CONTROL
3	V805000000	4	++BOLT, TORX 5x16	++PERNO TORX 5x16
4	P100002240	1	+CABLE ASSY, CONTROL	+MONTAJE DE CABLE PARA CONTROL
5	9154503010	1	++SCREW 3x10	++TORNILLO 3x10
6	A444000020	1	++KNOB, SWITCH - ORANGE	++BOTÓN DE INTERRUPTOR - NARANJA
7	V541000600	1	++SEAL, SWITCH	++SELLO DE INTERRUPTOR
8	90051800006	1	+NUT, FLANGE M6	+TUERCA-BRIDA M6
9	90050200006	1	+NUT M6	+TUERCA M6
10	C453000482	1	+TRIGGER, THROTTLE	+GATILLO DEL ACELERADOR
11	V452001520	1	+SPRING, TORSION	+RESORTE DE TORSIÓN
12	C460000441	1	+LEVER, THROTTLE LOCKOUT	+PALANCA SEGURO DEL ACELERADOR
13	V452001510	1	+SPRING, TORSION	+RESORTE DE TORSIÓN
14	V805000150	2	+BOLT, TORX 5x16	+PERNO TORX 5x16
15	V495003020	2	+CLAMP	+ABRAZADERA

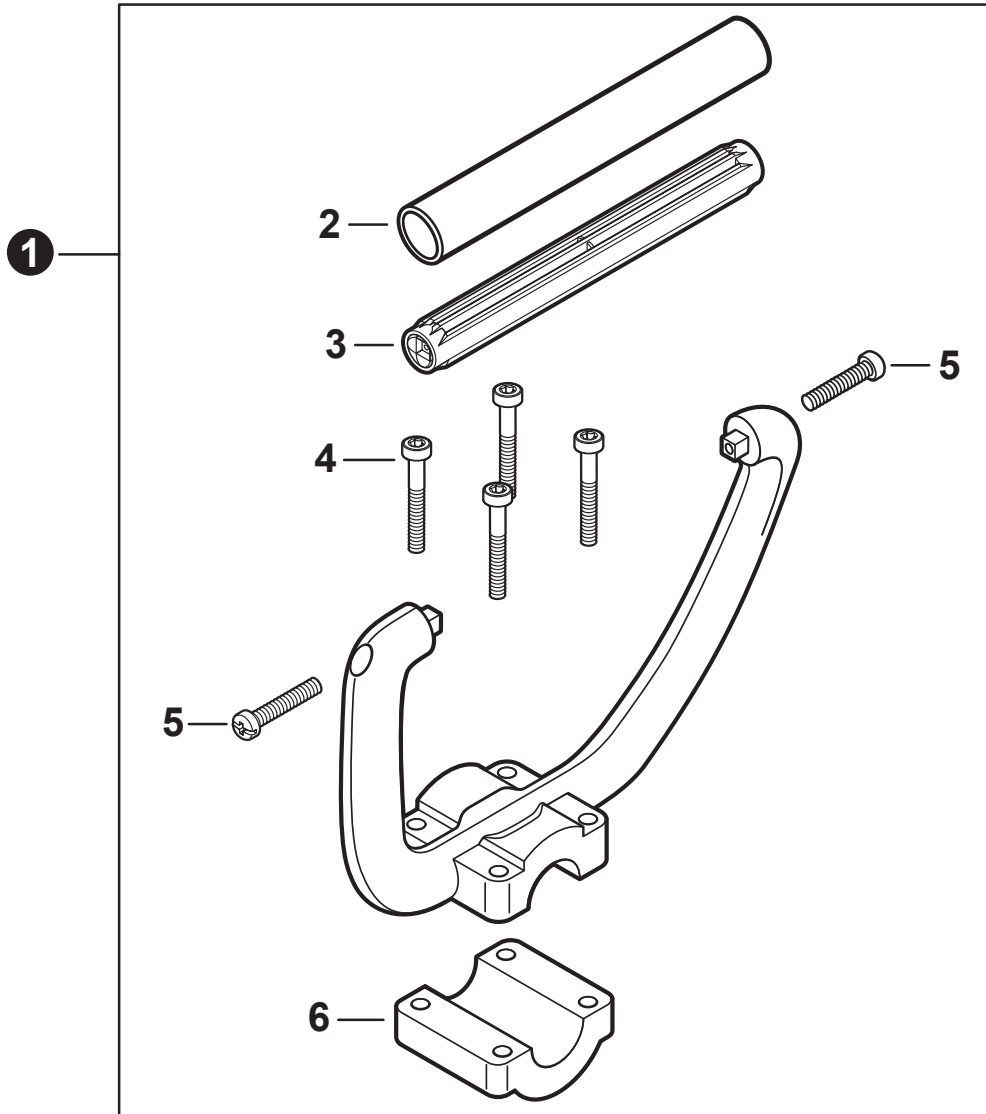

NO.	PART NUMBER	QTY.	DESCRIPTION	DESCRIPCIÓN
1	P021049270	1	HANDLE ASSY - SUPPORT	MONTAJE DE MANGO DE SOPORTE
2	35121351730	1	+GRIP, HANDLE	+AGARRE
3	35121051730	1	+HANDLE	+MANGO
4	V805000060	4	+BOLT, TORX 5x35	+PERNO TORX 5x35
5	90024605030	2	+SCREW 5x30	+TORNILLO 5x30
6	C423000300	1	+BRACKET, HANDLE	+SOPORTE DE MANGO

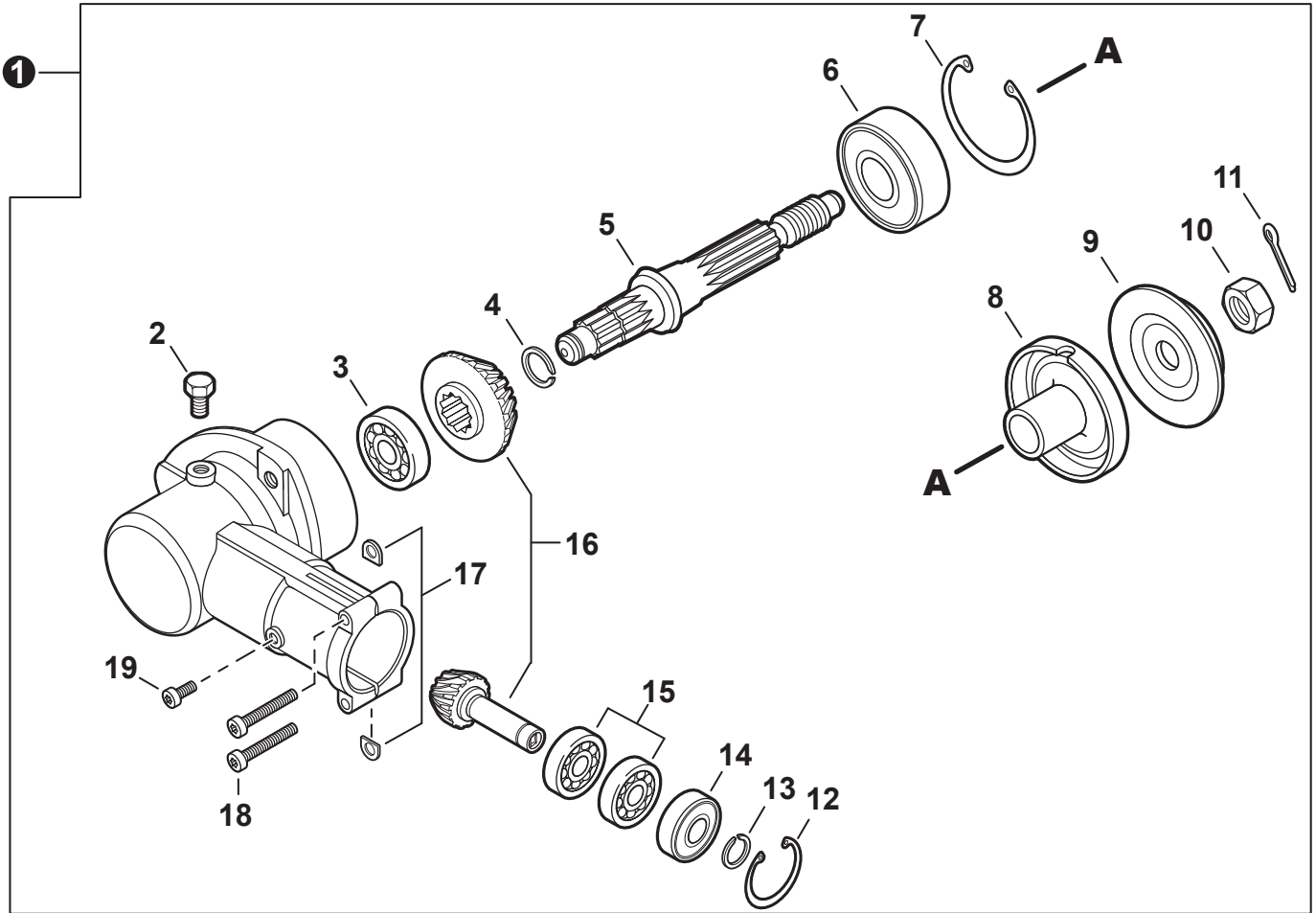

NO.	PART NUMBER	QTY.	DESCRIPTION	DESCRIPCIÓN
1	P021049410	1	GEAR CASE ASSY	MONTAJE DE CAJA DE ENGRANAJES
2	61043450031	1	+BOLT M8x8	+PERNO M8x8
3	90081000629	1	+BEARING, BALL 629	+COJINETE DE BOLAS 629
4	90070600012	1	+RING, SNAP 12	+ANILLO RETENEDOR 12
5	C534001050	1	+SHAFT, GEAR	+EJE DE ENGRANAJE
6	90081206302	1	+BEARING, BALL 6302	+COJINETE DE BOLAS 6302
7	90070200042	1	+RING, SNAP 42	+ANILLO RETENEDOR 42
8	C535000100	1	+PLATE, ADAPTOR - UPPER	+PLACA DEL ADAPTADOR SUPERIOR
9	C535000150	1	+PLATE, ADAPTOR - LOWER	+PLACA DEL ADAPTADOR INFERIOR
10	90051300010	1	+NUT 10x1.25 LH	+TUERCA 10x1.25 LH
11	90030020022	1	+PIN, COTTER 2x22	+PASADOR DE CHAVETA 2x22
12	90070200022	1	+RING, SNAP 22	+ANILLO RETENEDOR 22
13	90070600010	1	+RING, SNAP 10	+ANILLO RETENEDOR 10
14	90085806900	1	+BEARING, BALL 6900Z	+COJINETE DE BOLAS 6900Z
15	90085506900	2	+BEARING, BALL 6900	+COJINETE DE BOLAS 6900
16	P021046191	1	+GEAR SET	+JUEGO DE ENGRANAJES
17	61023904130	2	+D-WASHER	+ARANDELA D
18	V805000170	2	+BOLT, TORX 5x25	+PERNO TORX 5x25
19	V805000140	1	+BOLT, TORX 5x12	+PERNO TORX 5x12

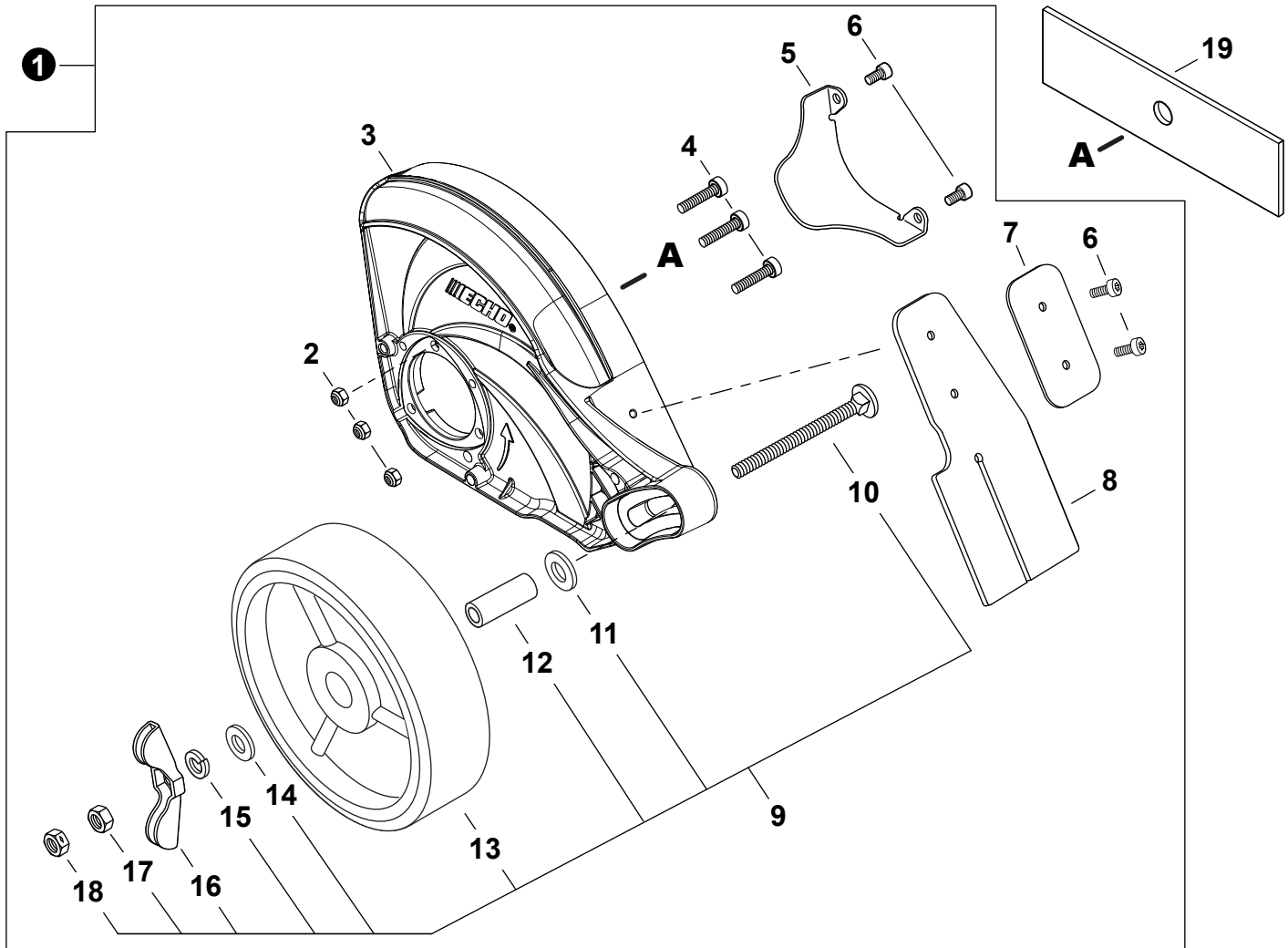

NO.	PART NUMBER	QTY.	DESCRIPTION	DESCRIPCIÓN
1	P021049311	1	SHIELD KIT, EDGER	KIT DE PROTECTOR PARA LA ORILLADORA
2	90056250005	3	+NUT, LOCK M5	+CONTRATUERCA M5
3	C550000930	1	+SHIELD, BLADE	+PROTECTOR PARA CUCHILLA
4	V805000160	3	+BOLT, TORX 5x20	+PERNO TORX 5x20
5	C557000430	1	+GUARD, SHIELD	+PROTECTOR
6	V804000000	4	+BOLT, TORX 4x12	+PERNO TORX 4x12
7	C552000260	1	+PLATE, FLAP	+PLACA DE ALETA
8	C550000730	1	+FLAP, DEBRIS	+ALETA DE RESIDUOS
9	P021054320	1	+WHEEL KIT	+JUEGO DE RUEDA
10	V205001220	1	++BOLT M8-1.25x80 MM	++PERNO M8-1.25x80 MM
11	90060200010	1	++WASHER M10	++ARANDELA M10
12	30242452630	1	++COLLAR 12	++COLLAR 12
13	C730000120	1	++WHEEL	++RUEDA
14	90060200008	1	++WASHER 8	++ARANDELA 8
15	90060500008	1	++WASHER, SPRING 8	++ARANDELA DE PRESION 8
16	V299000441	1	++KNOB, FASTENER	++PERILLA DE FIJACIÓN
17	90050000008	1	++NUT M8	++TUERCA M8
18	V265000340	1	++NUT, LOCK M8	++CONTRATUERCA M8
19	69601552632	1	BLADE - 2 PK	CUCHILLA - 2 PAQUETE



NO.	PART NUMBER	QTY.	DESCRIPTION	DESCRIPCIÓN
1	X503014970	1	LABEL - MODEL PE-2620S	ETIQUETA MODELO PE-2620S
2	X547003430	1	LABEL - RECOIL STARTER - PE-2620S	ETIQUETA ARRANCADOR - PE-2620S

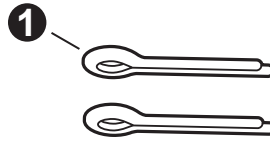

NO.	PART NUMBER	QTY.	DESCRIPTION	DESCRIPCIÓN
1	90030020022	2	PIN, COTTER 2x22	PASADOR DE CHAVETA 2x22

Maintenance Kits
Kits de Mantenimiento

NO.	PART NUMBER	QTY.	DESCRIPTION	DESCRIPCIÓN
1	90181Y	1	TUNE-UP KIT - YOUCAN™	JUEGO DE PUESTA A PUNTO - YOUCAN™
2	A226002040	1	+PRE-FILTER, FOAM	+PRÉ-FILTRO DE ESPUMA
3	A226002030	1	+FILTER, AIR	+FILTRO DE AIRE
4	A369000470	1	+FILTER, FUEL	+FILTRO DE COMBUSTIBLE
5	A425000060	1	+SPARK PLUG - CMR7H	+BUJÍA - CMR7H
6	90261Y	1	FUEL SYSTEM KIT - YOUCAN™	KIT DEL SISTEMA DE COMBUSTIBLE - YOUCAN™
7	13201040830	1	+PIPE, FUEL 3x6x75 CLEAR	+TUBO DE COMBUSTIBLE 3x6x75 TRANSPARENTE
8	V186000500	1	+CONNECTOR, PIPE	+CONECTOR DE TUBO
9	A356000230	1	+VENT ASSY	+VÁLVULA DE RESPIRADERO
10	V490001230	1	+CLIP 6.5 MM	+SUJETADOR 6.5 MM
11	13201006531	1	+PIPE, FUEL 3x6x85 BLACK	+TUBO DE COMBUSTIBLE 3x6x85 NEGRO
12	V471005640	1	+PIPE, FUEL 3x5.5x80 BLACK	+TUBO DE COMBUSTIBLE 3x5.5x80 NEGRO
13	13211555931	1	+GROMMET, FUEL	+OJAL DE COMBUSTIBLE
14	10092735830	1	+PIPE 3x7x10 - BLACK	+TUBO 3x7x10 NEGRO
15	V186000520	1	+CONNECTOR, PIPE 5x3.5	+CONECTOR DE TUBO 5x3.5
16	V490001240	2	+CLIP 6	+SUJETADOR 6
17	V471003661	1	+PIPE, FUEL 3x5x115 BLACK	+TUBO DE COMBUSTIBLE 3x5x115 NEGRO
18	A413000190	1	+BOOT	+BOTA
19	A369000470	1	+FILTER, FUEL	+FILTRO DE COMBUSTIBLE
20	V107000230	1	+GASKET, FUEL CAP	+EMPAQUETADURA DE TAPA DE COMBUSTIBLE
21	A263000020	1	+BULB, PURGE	+BULBO DE PURGA
22	P021051540	1	GASKET KIT: ENGINE, INTAKE, EXHAUST	JUEGO DE EMPAQUETADURA - MOTOR, ADMISIÓN, ESCAPE
23	V100000840	1	+GASKET, CYLINDER	+EMPAQUETADURA DE CILINDRO
24	V102000300	1	+GASKET, CRANKCASE	+EMPAQUETADURA DE CÁRTER
25	V103001900	1	+GASKET, INTAKE	+EMPAQUETADURA DE ADMISIÓN
26	V103001890	1	+HEAT SHIELD, INTAKE	+PROTECTOR TÉRMICO DEL ADMISIÓN
27	V104002310	1	+HEAT SHIELD, EXHAUST	+PROTECTOR TÉRMICO DEL ESCAPE

Bulk Pipe
Tubo al por mayor



NO.	PART NUMBER	QTY.	DESCRIPTION	DESCRIPCIÓN
1	90014	1	BULK PIPE - 3x5 MM BLACK (4 PIECESx2 M)	TUBO AL POR MAYOR 3x5 MM NEGRO (4 PIEZASx2 M)
2	90015	1	BULK PIPE - 3x6 MM BLACK (4 PIECESx2 M)	TUBO AL POR MAYOR 3x6 MM NEGRO (4 PIEZASx2 M)
3	90016	1	BULK PIPE - 3x7 MM BLACK (4 PIECESx2 M)	TUBO AL POR MAYOR 3x7 MM NEGRO (4 PIEZASx2 M)
4	90017	1	BULK PIPE - 3x6 MM CLEAR (4 PIECESx2 M)	TUBO AL POR MAYOR 3x6 MM TRANSPARENTE (4 PIEZASx2 M)
5	90018	1	BULK PIPE - 2x4 MM CLEAR (4 PIECESx2 M)	TUBO AL POR MAYOR 2x4 MM TRANSPARENTE (4 PIEZASx2 M)

Bulk Starter Rope
Cuerda del arrancador al por mayor

NO.	PART NUMBER	QTY.	DESCRIPTION	DESCRIPCIÓN
1	99944435000	1	BULK STARTER ROPE - 2.3 MMx61 M	CUERDA DEL ARRANCADOR AL POR MAYOR 2.3 MMx61 M
2	99944440000	1	BULK STARTER ROPE - 3.0 MMx61 M	CUERDA DEL ARRANCADOR AL POR MAYOR 3.0 MMx61 M
3	99944445000	1	BULK STARTER ROPE - 3.5 MMx61 M	CUERDA DEL ARRANCADOR AL POR MAYOR 3.5 MMx61 M
4	99944450000	1	BULK STARTER ROPE - 4.0 MMx61 M	CUERDA DEL ARRANCADOR AL POR MAYOR 4.0 MMx61 M
5	99944455000	1	BULK STARTER ROPE - 4.4 MMx61 M	CUERDA DEL ARRANCADOR AL POR MAYOR 4.4 MMx61 M
6	99944460000	1	BULK STARTER ROPE - 4.8 MMx61 M	CUERDA DEL ARRANCADOR AL POR MAYOR 4.8 MMx61 M