



Accessories for ECHO products can be found at:

Los accesorios para los productos ECHO se pueden encontrar en:

www.echo-usa.com/products/catalogs

OPTIONAL ACCESSORIES & ATTACHMENTS:

Rain Gutter Kit	99944100025
Curved Tip Blower Tube	E165000160

ACCESORIOS OPCIONALES

Juego de canaletas para limpiezas	99944100025
Tubo de Soplado de punta curva	E165000160

ECHO, INCORPORATED

400 Oakwood Road, Lake Zurich, Illinois 60047

WWW.ECHO-USA.COM

©2015 ECHO, Incorporated. All Rights Reserved

**PARTS CATALOG
LISTA DE PIEZAS**

**PB-265LN
Backpack Blower**

PB-265LN Soplador de mochila



25.4 cc

SERIAL NUMBER
NÚMERO DE SERIE

P35312001001 - P35312999999

P/N 99922201419
REVISED 05/01/2015

Intake, Air Filter	3
Admisión, Filtro de aire	
Engine	4
Motor	
Engine	5
Motor	
Carburetor, RB-K85	6
Carburador, RB-K85	
Carburetor, RB-K85	7
Carburador, RB-K85	
Exhaust	8
Escape	
Flywheel, Ignition	9
Volante, Encendido	
Recoil Starter	10
Arrancador Autorretráctil	
Fuel System	11
Sistema de combustible	
Backpack Frame, Harness	12
Armazón de mochila, Arnés	
Fan Case	13
Caja de ventilador	
Hip Mount Throttle	14
Acelerador sujeto a la cadera	
Hip Mount Throttle	15
Acelerador sujeto a la cadera	
Posi-Loc Blower Tubes	16
Tubos Sopladores Posi-Loc	
Labels	17
Etiquetas	
RePower Maintenance Kits	18
Juegos de mantenimiento RePower	

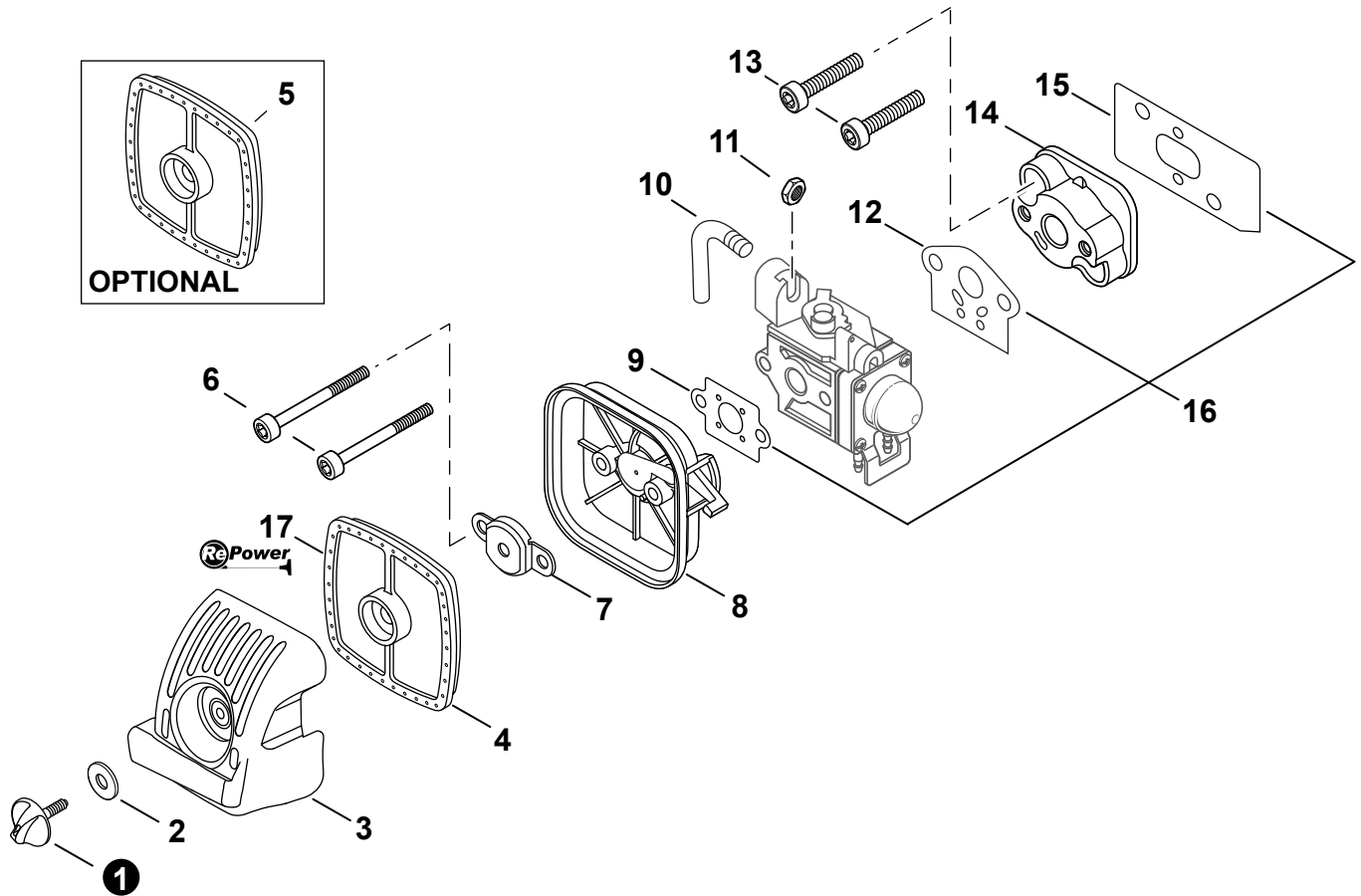

NO.	PART NUMBER	QTY.	DESCRIPTION	DESCRIPCIÓN
1	V299000250	1	THUMBSCREW	TORNILLO DE OREJETAS
2	13191103460	1	WASHER 5.5×16×0.8	ARANDELA 5.5×16×0.8
3	A232000340	1	COVER, AIR FILTER	CUBIERTA DEL FILTRO DE AIRE
4	A226000472	1	FILTER, AIR - DOUBLE LAYER	FILTRO DE AIRE - CAPA DOBLE
5	A226000350	1	FILTER, AIR	FILTRO DE AIRE
6	90010505060	2	BOLT 5×60	PERNO 5×60
7	A244000070	1	PLATE, PREVENT	PLACA DE PREVENCIÓN
8	P021010980	1	CASE ASSY, AIR FILTER	MONTAJE DE CAJA DEL FILTRO DE AIRE
9	13001642031	1	GASKET, INTAKE	EMPAQUETADURA DE ADMISIÓN
10	C482000040	1	ADJUSTER, THROTTLE CABLE	AJUSTADOR DE CABLE DEL ACELERADOR
11	9200307000	1	NUT 3N-7	TUERCA 3N-7
12	13001013410	1	GASKET, CARBURETOR	EMPAQUETADURA DE CARBURADOR
13	90016205025	2	BOLT 5×25	PERNO 5×25
14	A200000280	1	INSULATOR, INTAKE	AISLADOR DE ADMISIÓN
15	V103000300	1	GASKET, INTAKE	EMPAQUETADURA DE ADMISIÓN
16	P021012380	1	GASKET KIT	JUEGO DE EMPAQUETADURA
17	90154	1	TUNE-UP KIT - REPOWER	JUEGO DE PUESTA A PUNTO - REPOWER

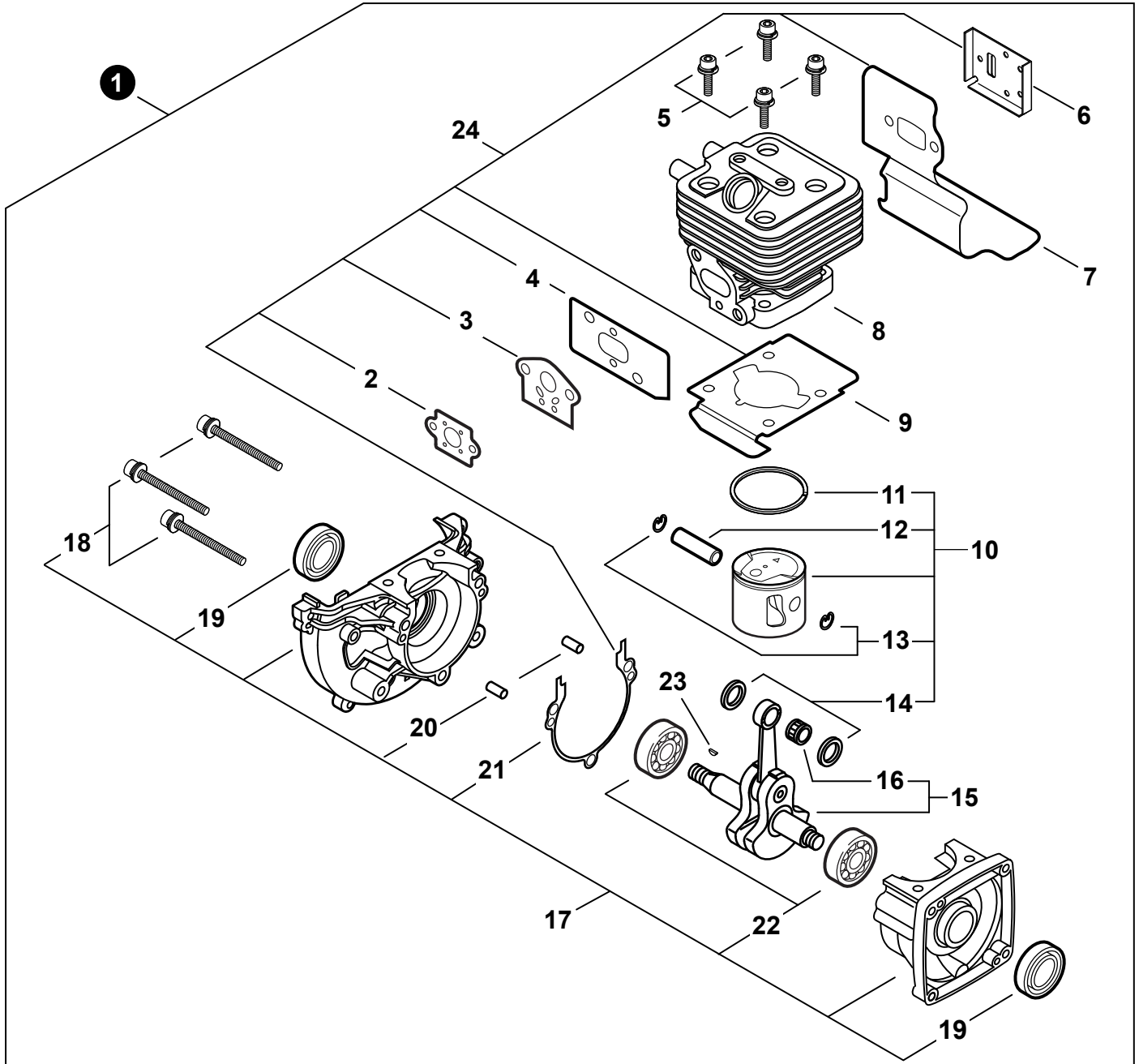

NO.	PART NUMBER	QTY.	DESCRIPTION	DESCRIPCIÓN
1	SB1098	1	SHORT BLOCK	BLOQUE CORTO
2	13001642031	1	+GASKET, INTAKE	+EMPAQUETADURA DE ADMISIÓN
3	13001013410	1	+GASKET, CARBURETOR	+EMPAQUETADURA DE CARBURADOR
4	V103000300	1	+GASKET, INTAKE	+EMPAQUETADURA DE ADMISIÓN
5	90016205025	4	+BOLT 5×25	+PERNO 5×25
6	V104000840	1	+GASKET, EXHAUST	+EMPAQUETADURA DE ESCAPE
7	V104000750	1	+HEAT SHIELD, EXHAUST	+PROTECTOR TÉRMICO DEL ESCAPE
8	A130000780	1	+CYLINDER	+CILINDRO
9	V100000190	1	+GASKET, CYLINDER	+EMPAQUETADURA DE CILINDRO
10	P021010260	1	+PISTON KIT	+JUEGO DE PISTÓN
11	A101000140	1	++RING, PISTON	++ANILLO DEL PISTÓN
12	V606000000	1	++PIN, PISTON 5×8×28	++PASADOR DEL PISTÓN 5×8×28
13	10001504630	2	++RING, SNAP	++ANILLO RETENEDOR
14	10001411520	2	++WASHER, THRUST 8.2×13×0.5	++ARANDELA DE EMPUJE 8.2×13×0.5
15	A011000371	1	+CRANKSHAFT ASSY	+MONTAJE DE CIGÜEÑAL
16	V553000010	1	++BEARING, NEEDLE 8	++COJINETE DE AGUJAS 8
17	P021008231	1	+CRANKCASE KIT	+JUEGO DE CÁRTER
18	90016205028	3	++BOLT 5×28	++PERNO 5×28
19	10021242031	2	++SEAL, OIL 12	++SELLO DE ACEITE 12
20	90033040080	2	++PIN, LOCATING 4×8	++PASADOR DE POSICIONAMIENTO 4×8
21	10024242030	1	++GASKET, CRANKCASE	++EMPAQUETADURA DE CÁRTER
22	9403536201	2	++BEARING, BALL 6201	++COJINETE DE BALINES 6201
23	10014212330	1	+KEY, WOODRUFF	+CHAVETA WOODRUFF
24	P021012380	1	GASKET KIT	JUEGO DE EMPAQUETADURA

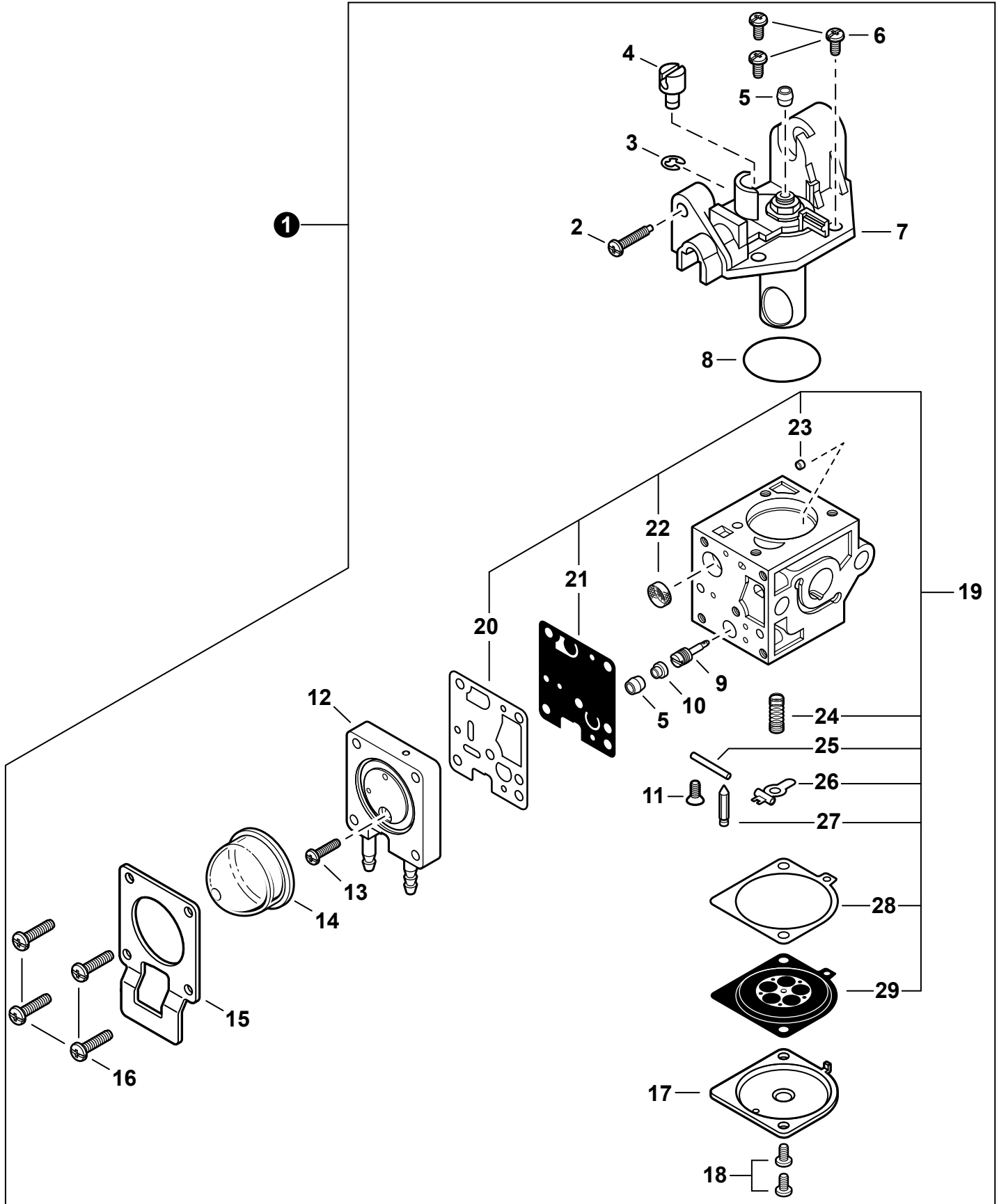

NO.	PART NUMBER	QTY.	DESCRIPTION	DESCRIPCIÓN
1	A021001350	1	CARBURETOR RB-K85	CARBURADOR RB-K85
2	P005000100	1	+SCREW, THROTTLE ADJUST	+TORNILLO AJUSTE DE TENSION DEL ACELERADOR
3	P005000190	1	+E-RING	+RETENEDOR TIPO "E"
4	P005002090	1	+SWIVEL	+CONECTOR GIRATORIO
5	P005001270	2	+CAP, LIMITER	+PROTECTOR DE TORNILLO
6	12534413931	3	+SCREW	+TORNILLO
7	P005002000	1	+COVER ASSY, ROTOR	+MONTAJE DE CUBIERTA DE ROTOR
8	P005000280	1	+O-RING	+JUNTA TÓRICA
9	P005001260	1	+NEEDLE, HIGH SPEED	+AGUJA DE REGULACION ALTA (H)
10	P005001250	1	+PLUG	+TAPÓN
11	12533942030	1	+SCREW	+TORNILLO
12	P005001890	1	+BODY ASSY, PURGE	+MONTAJE DE CUERPO PURGACIÓN
13	P005000270	1	+SCREW	+TORNILLO
14	12538146730	1	+BULB, PURGE	+BULBO DE PURGA
15	P005000250	1	+RETAINER, PURGE BULB	+SUJETADOR DE BULBO DE PURGA
16	P005001900	4	+SCREW	+TORNILLO
17	12534252130	1	+COVER, METERING DIAPHRAGM	+TAPA DE DIAFRAGMA DE MEDICIÓN
18	12534452130	2	+SCREW	+TORNILLO
19	P005001670	1	+REPAIR KIT	+JUEGO DE REPARACIÓN
20		1	++GASKET, PUMP	++EMPAQUETADURA DE LA BOMBA
21		1	++DIAPHRAGM, PUMP	++DIAFRAGMA DE LA BOMBA
22		1	++SCREEN, FUEL INLET	++MALLA FILTRADORA
23		1	++GUIDE, ROLLER	++GUÍA DE RODILLO
24		1	++SPRING, METERING LEVER	++RESORTE PALANCA DE MEDICIÓN
25		1	++PIN, METERING LEVER	++PASADOR DE PALANCA DE MEDICIÓN
26		1	++LEVER, METERING	++PALANCA DE MEDICIÓN
27		1	++VALVE, INLET NEEDLE	++VÁLVULA REGULADORA
28		1	++GASKET, METERING DIAPHRAGM	++EMPAQUETADURA DIAFRAGMA DE MEDICIÓN
29		1	++DIAPHRAGM, METERING	++DIAFRAGMA DE MEDICIÓN

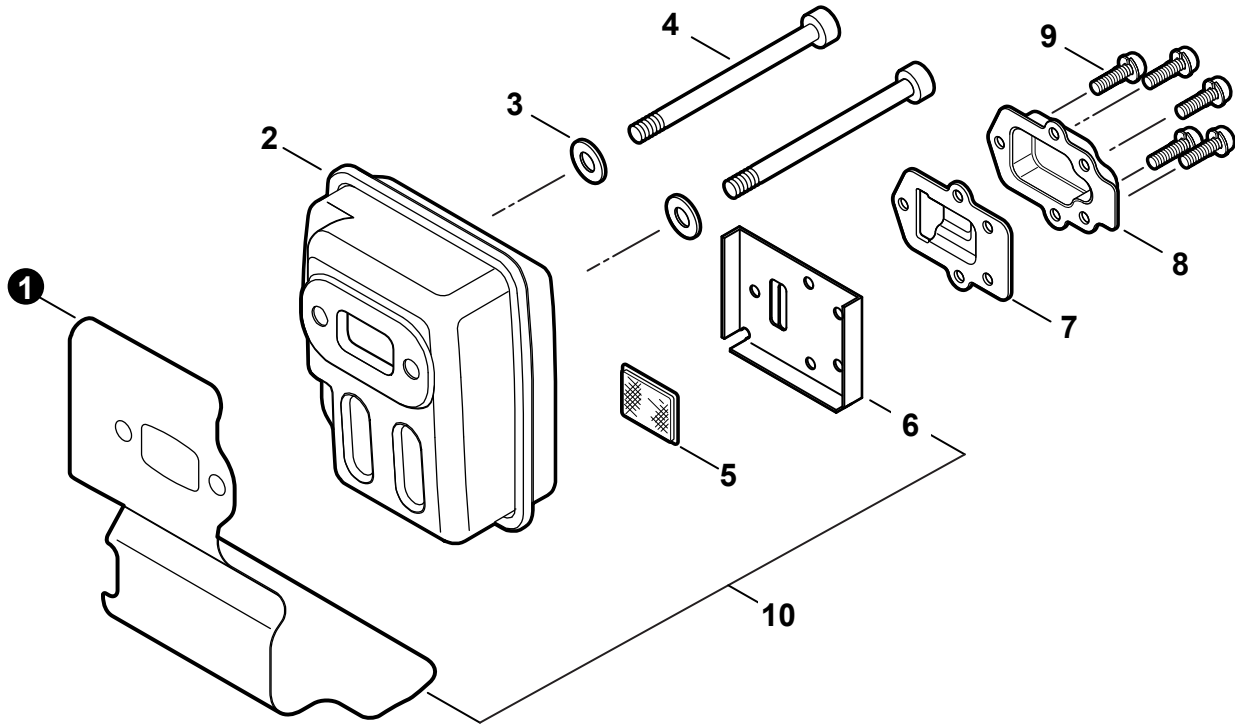

NO.	PART NUMBER	QTY.	DESCRIPTION	DESCRIPCIÓN
1	V104000750	1	HEAT SHIELD, EXHAUST	PROTECTOR TÉRMICO DEL ESCAPE
2	A300000810	1	MUFFLER	SILENCIADOR
3	90060300005	2	WASHER 5.5×12×0.8	ARANDELA 5.5×12×0.8
4	V203000190	2	BOLT 5	PERNO 5
5	A310000070	1	SCREEN, SPARK ARRESTER	PANTALLA DEL GUARDACHISPAS
6	V104000840	1	GASKET, EXHAUST	EMPAQUETADURA DE ESCAPE
7	A313000840	1	GUIDE, EXHAUST	GUÍA DE ESCAPE
8	A313000821	1	OUTLET, EXHAUST	SALIDA DE ESCAPE
9	9136704010	5	SCREW 4×10	TORNILLO 4×10
10	P021012380	1	GASKET KIT	JUEGO DE EMPAQUETADURA

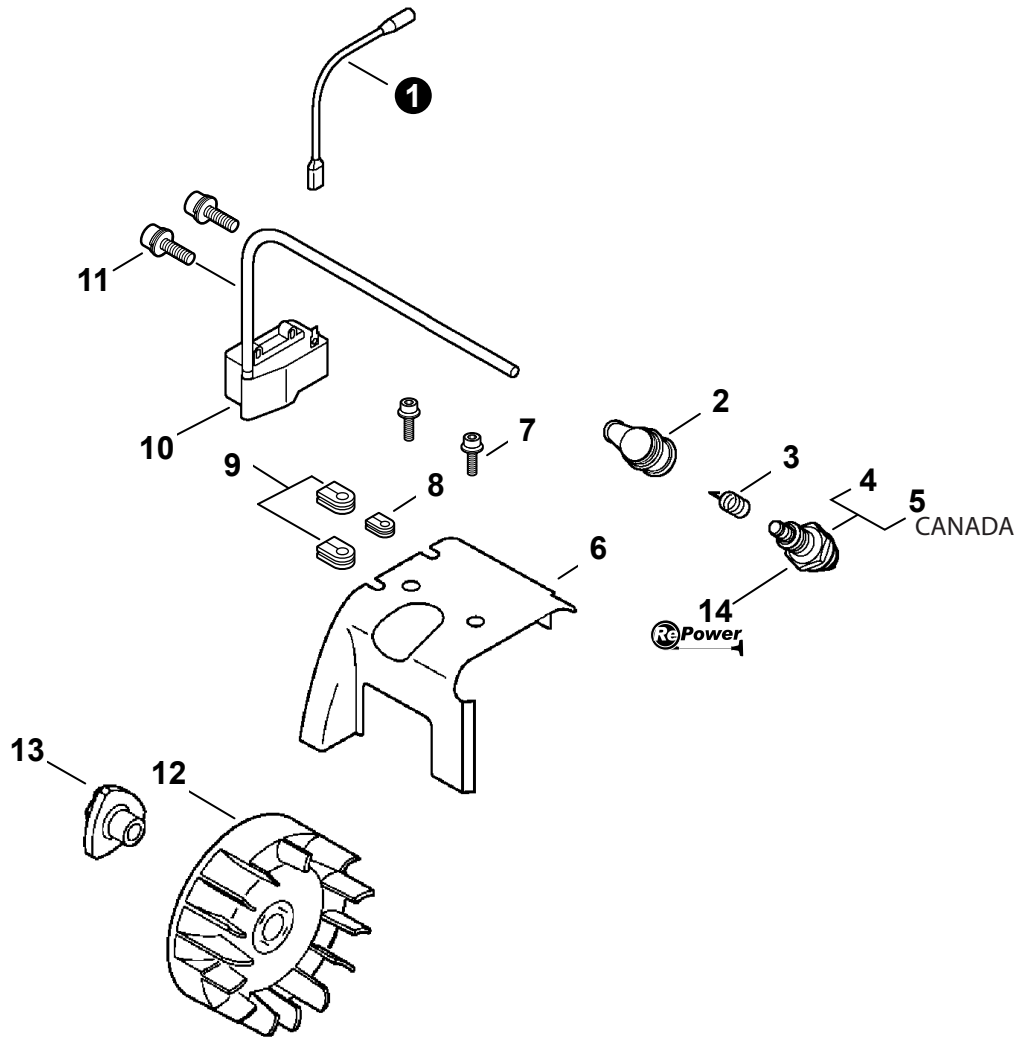

NO.	PART NUMBER	QTY.	DESCRIPTION	DESCRIPCIÓN
1	V485000740	1	LEAD - IGNITION	CABLE DE ENCENDIDO
2	A427000013	1	CAP, SPARK PLUG	TAPA DE BUJÍA
3	A426000010	1	TERMINAL, SPARK PLUG	TERMINAL DE BUJÍA
4	15901019830	1	SPARK PLUG - BPM-8Y	BUJÍA BPM-8Y
5	A425000000	1	SPARK PLUG - BPMR-8Y	BUJÍA BPMR-8Y
6	A160000771	1	COVER, CYLINDER	CUBIERTA DEL CILINDRO
7	90010605008	2	BOLT 5×8	PERNO 5×8
8	15211505530	1	GROMMET	OJAL
9	15611004920	2	GROMMET, HT CORD	OJAL DE CABLE
10	A411000290	1	COIL, IGNITION	BOBINA DE ENCENDIDO
11	9111304020	2	BOLT 4×20	PERNO 4×20
12	A409000210	1	FLYWHEEL	VOLANTE
13	E101000122	1	HUB, FAN	CUBO DE VENTILADOR
14	90154	1	TUNE-UP KIT - REPOWER	JUEGO DE PUESTA A PUNTO - REPOWER

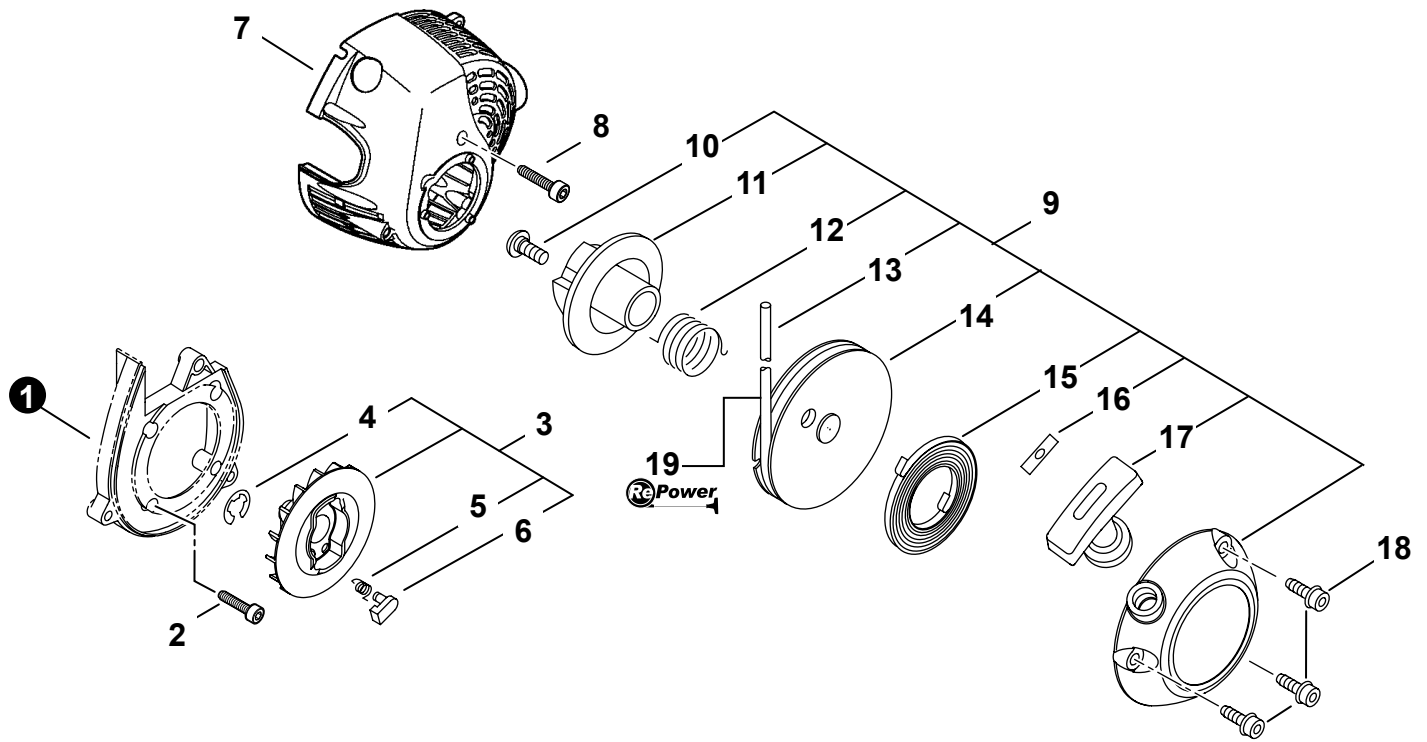

NO.	PART NUMBER	QTY.	DESCRIPTION	DESCRIPCIÓN
1	V376000830	1	SPACER	ESPACIADOR
2	90016304016	4	BOLT 4×16	PERNO 4×16
3	A052000250	1	PAWL ASSY, STARTER	MONTAJE DE TRINQUETE
4	90070000004	2	+E-RING 4	+RETENEDOR TIPO "E" 4
5	17723412220	2	+SPRING, RETURN	+RESORTE DE RETORNO
6	P022006850	2	+PAWL, STARTER	+TRINQUETE
7	A190000581	1	COVER, ENGINE	CUBIERTA DEL MOTOR
8	9114505020	7	SCREW TAPPING 5×20	TORNILLO ROSCADO 5×20
9	A050000111	1	STARTER ASSY, RECOIL	MONTAJE DE ARRANCADOR AUTORRETRÁCTIL
10	17723661830	1	+SCREW	+TORNILLO
11	P022028000	1	+PLATE, CAM	+PLACA DE LEVA
12	P022008270	1	+SPRING, TORSION	+RESORTE DE TORSIÓN
13	P022008260	1	+ROPE, STARTER 3×700	+CUERDA DEL ARRANCADOR 3×700
14	P022027980	1	+REEL, ROPE	+CARRETE DEL CABLE
15	17722042030	1	+SPRING, RECOIL	+RESORTE RECULAR
16	17724611120	1	+RETAINER, ROPE	+RETENEDOR DE CUERDA
17	17722827030	1	+GRIP, STARTER	+AGARRE DEL ARRANCADOR
18	9114505016	3	SCREW TAPPING 5×16	TORNILLO ROSCADO 5×16
19	99944440000	1	ROPE, STARTER - REPOWER BULK Ø3	CUERDA DEL ARRANCADOR REPOWER AL POR MAYOR

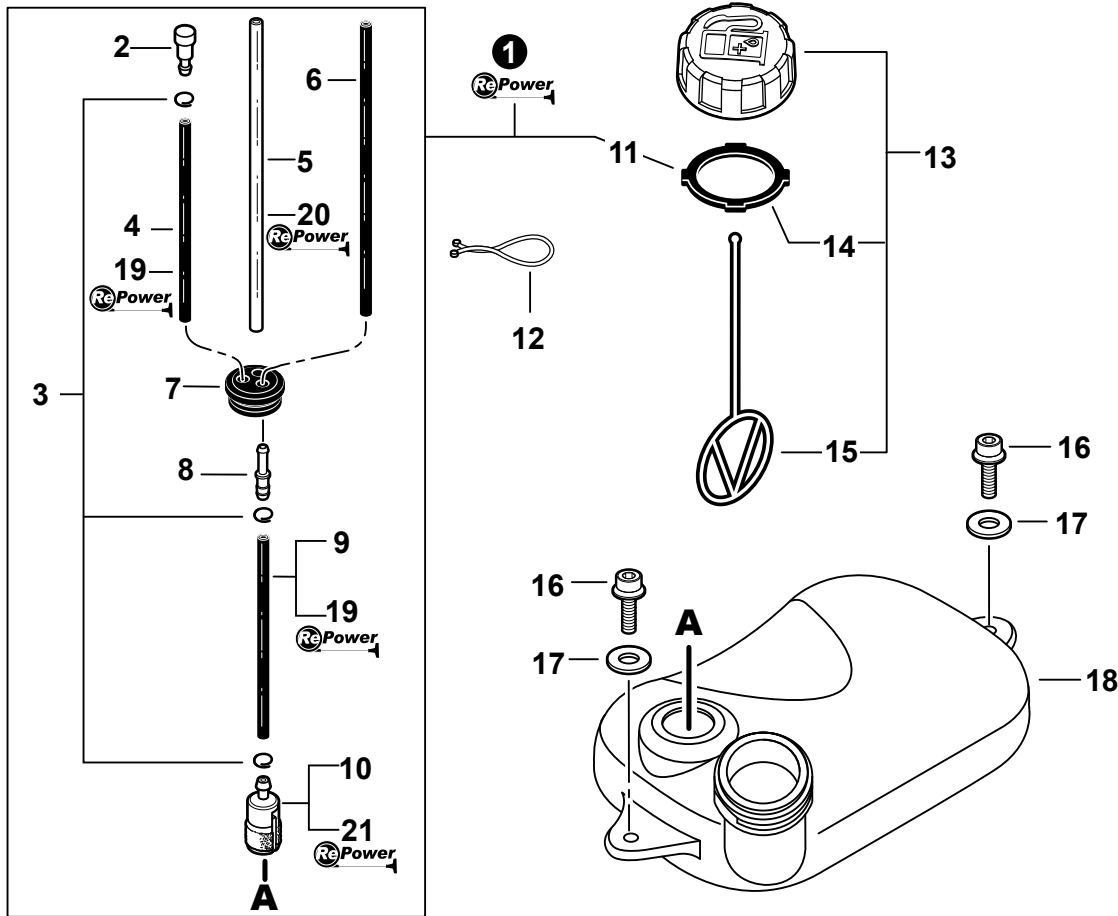

NO.	PART NUMBER	QTY.	DESCRIPTION	DESCRIPCIÓN
1	90126	1	FUEL SYSTEM KIT - REPOWER	KIT DEL SISTEMA DE COMBUSTIBLE - REPOWER
2	A356000031	1	+VENT ASSY	+VÁLVULA DE RESPIRADERO
3	V490001240	3	+CLIP Ø6	+SUJETADOR Ø6
4	V471001200	1	+PIPE, FUEL 3×5×70 BLACK	+TUBO DE COMBUSTIBLE 3×5×70 NEGRO
5	V471003000	1	+PIPE, FUEL 3×6×125	+TUBO DE COMBUSTIBLE 3×6×125
6	V471003610	1	+PIPE, FUEL - 3×5×120 - BLACK	+TUBO DE COMBUSTIBLE 3×5×120 NEGRO
7	13211555930	1	+GROMMET, FUEL	+OJAL DE COMBUSTIBLE
8	V186000520	1	+CONNECTOR, PIPE Ø5×Ø3.5	+CONECTOR DE TUBO Ø5×Ø3.5
9	V471001210	1	+PIPE, FUEL 3×5×90 BLACK	+TUBO DE COMBUSTIBLE 3×5×90 NEGRO
10	13120507320	1	+FILTER, FUEL	+FILTRO DE COMBUSTIBLE
11	V107000150	1	+GASKET, FUEL CAP	+EMPAQUETADURA DEL TAPA DE COMBUSTIBLE
12	13201305060	1	CLIP, TUBE	SUJETADOR DE TUBO
13	P021040030	1	CAP ASSY, FUEL	MONTAJE DE TAPA DE COMBUSTIBLE
14	V107000150	1	+GASKET, FUEL CAP	+EMPAQUETADURA DEL TAPA DE COMBUSTIBLE
15	13105156030	1	+CONNECTOR, CAP L= 100mm	+CONECTOR DE TAPA L= 100mm
16	9114705020	2	BOLT 5×20	PERNO 5×20
17	61301907350	2	WASHER 5.5×16×2T	ARANDELA 5.5×16×2T
18	A350000880	1	TANK, FUEL	TANQUE DE COMBUSTIBLE
19	90014	1	PIPE, FUEL - REPOWER BULK 3×5mm BLACK	TUBO REPOWER AL POR MAYOR 3×5mm NEGRO
20	90017	1	PIPE, FUEL - REPOWER BULK 3×6mm CLEAR	TUBO REPOWER AL POR MAYOR 3×6mm TRANSPARENTE
21	90154	1	TUNE-UP KIT - REPOWER	JUEGO DE PUESTA A PUNTO - REPOWER

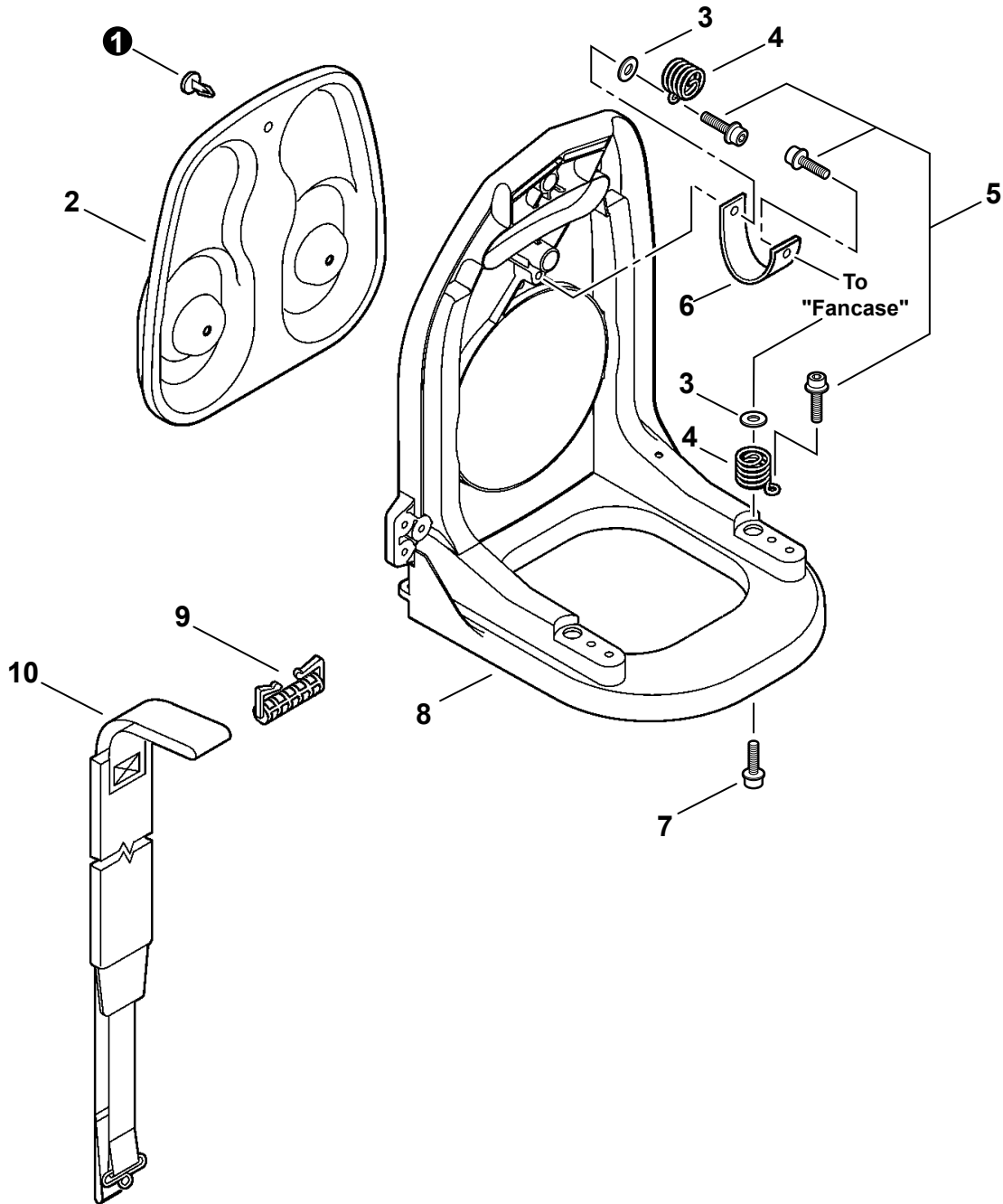

NO.	PART NUMBER	QTY.	DESCRIPTION	DESCRIPCIÓN
1	30033306160	3	CLIP	SUJETADOR
2	C630000040	1	CUSHION, BACKPACK	AMORTIGUADOR DE MOCHILA
3	61301907350	4	WASHER 5.5×16×2T	ARANDELA 5.5×16×2T
4	V450000551	3	SPRING, COMPRESSION	RESORTE DE COMPRESIÓN
5	9114705020	4	BOLT 5×20	PERNO 5×20
6	C617000380	1	STRAP, SAFETY 1.2×100	CINTA DE SEGURIDAD 1.2×100
7	90010605014	2	BOLT 5×14	PERNO 5×14
8	C620000290	1	FRAME, BACKPACK	ARMAZÓN DE MOCHILA
9	V491000040	2	CLIP, HARNESS	SUJETADOR DEL ARNÉS
10	C061000111	2	HARNESS ASSY, BACKPACK	MONTAJE DE ARNÉS TIPO MOCHILA

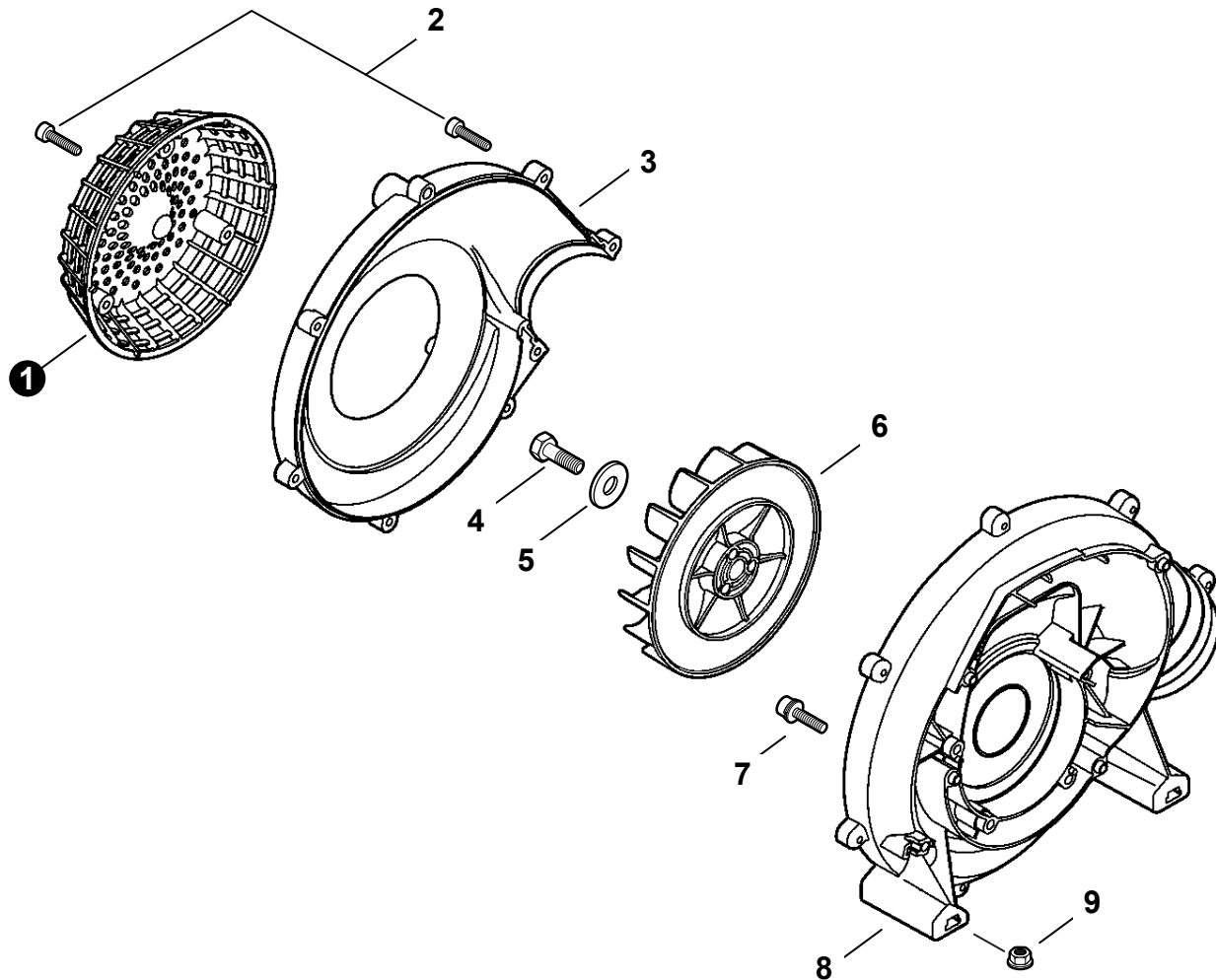

NO.	PART NUMBER	QTY.	DESCRIPTION	DESCRIPCIÓN
1	E104000071	1	GUARD, DEBRIS	PROTECTOR CONTRA RESIDUOS
2	9114505020	5	SCREW TAPPING 5×20	TORNILLO ROSCADO 5×20
3	E103000390	1	COVER, FAN	CUBIERTA DEL VENTILADOR
4	90010008014	1	BOLT 8×14	PERNO 8×14
5	10014319830	1	WASHER 8.2×31×0.8	ARANDELA 8.2×31×0.8
6	E100000260	1	FAN	VENTILADOR
7	90016204020	4	BOLT 4×20	PERNO 4×20
8	E103000380	1	CASE, FAN	CAJA DE VENTILADOR
9	V263000070	2	NUT, FLANGE 5	TUERCA-BRIDA 5

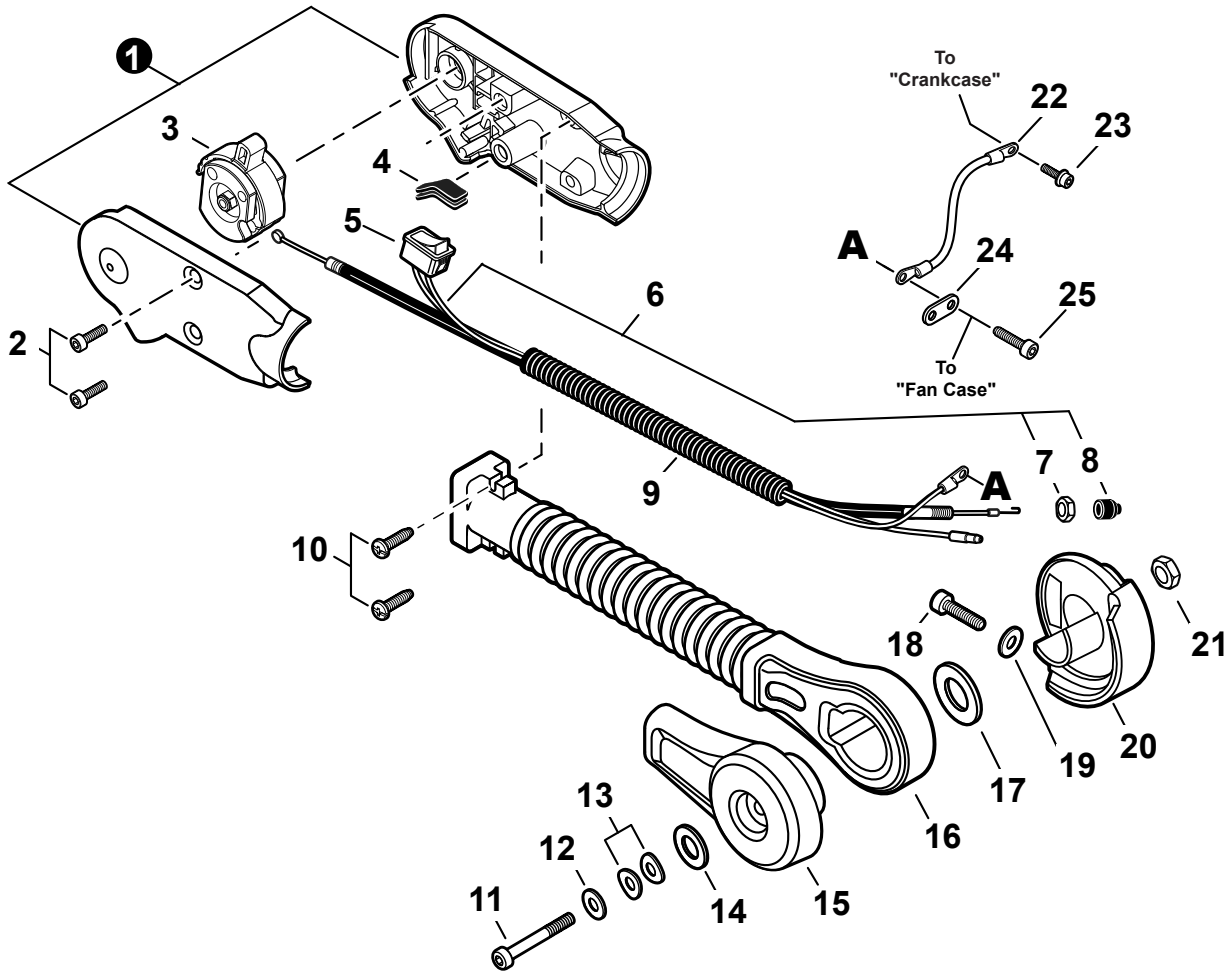

NO.	PART NUMBER	QTY.	DESCRIPTION	DESCRIPCIÓN
1	P021014672	1	CONTROL HANDLE SET	JUEGO DE MANGO PARA CONTROL
2	90010505014	2	BOLT 5×14	PERNO 5×14
3	C470000162	1	CONTROL, THROTTLE	CONTROL DEL ACELERADOR
4	V144000181	1	GROMMET	OJAL
5	A045000141	1	SWITCH, ON-OFF	INTERRUPTOR DE ENCENDIDO-APAGADO
6	V430001760	1	CABLE, THROTTLE	CABLE DEL ACELERADOR
7	90050000006	1	+NUT, HEX M6	+TUERCA HEXAGONAL 6M
8	17808208260	1	+CAP, DUST	+TAPA ANTIPOLVO
9	V475003820	1	TUBE, FLEXIBLE	TUBO FLEXIBLE
10	88995021060	2	SCREW 5	TORNILLO 5
11	V204000150	1	BOLT 6	PERNO 6
12	69911804560	1	WASHER 6.5×15.5×0.6	ARANDELA 6.5×15.5×0.6
13	17816021060	2	WASHER, FRICTION 6.6×14.3	ARANDELA DE FRICCIÓN 6.6×14.3
14	V304000040	1	WASHER 6.6×20×1.6	ARANDELA 6.6×20×1.6
15	C472000050	1	BRACKET, ARM - OUTER	SOPORTE DEL BRAZO - EXTERNO
16	C456000050	1	ARM, THROTTLE CONTROL	BRAZO DE CONTROL DEL ACELERADOR
17	V336000000	1	WASHER 36.5×56×1.0	ARANDELA 36.5×56×1.0
18	9114505025	3	BOLT, TAPPING 5×25	PERNO ROSCADOR 5×25
19	61301907350	3	WASHER 5.5×16×2T	ARANDELA 5.5×16×2T
20	C472000041	1	BRACKET, ARM - INNER	SOPORTE DEL BRAZO - INTERNO
21	90056250006	1	NUT, LOCK M6	CONTRATUERCA M6
22	V485000800	1	LEAD - GROUND	CABLE DE TIERRA
23	90010605008	1	BOLT 5×8	PERNO 5×8
24	V150001350	1	PLATE, EYE	PLACA
25	9114505016	1	SCREW TAPPING 5×16	TORNILLO ROSCADO 5×16

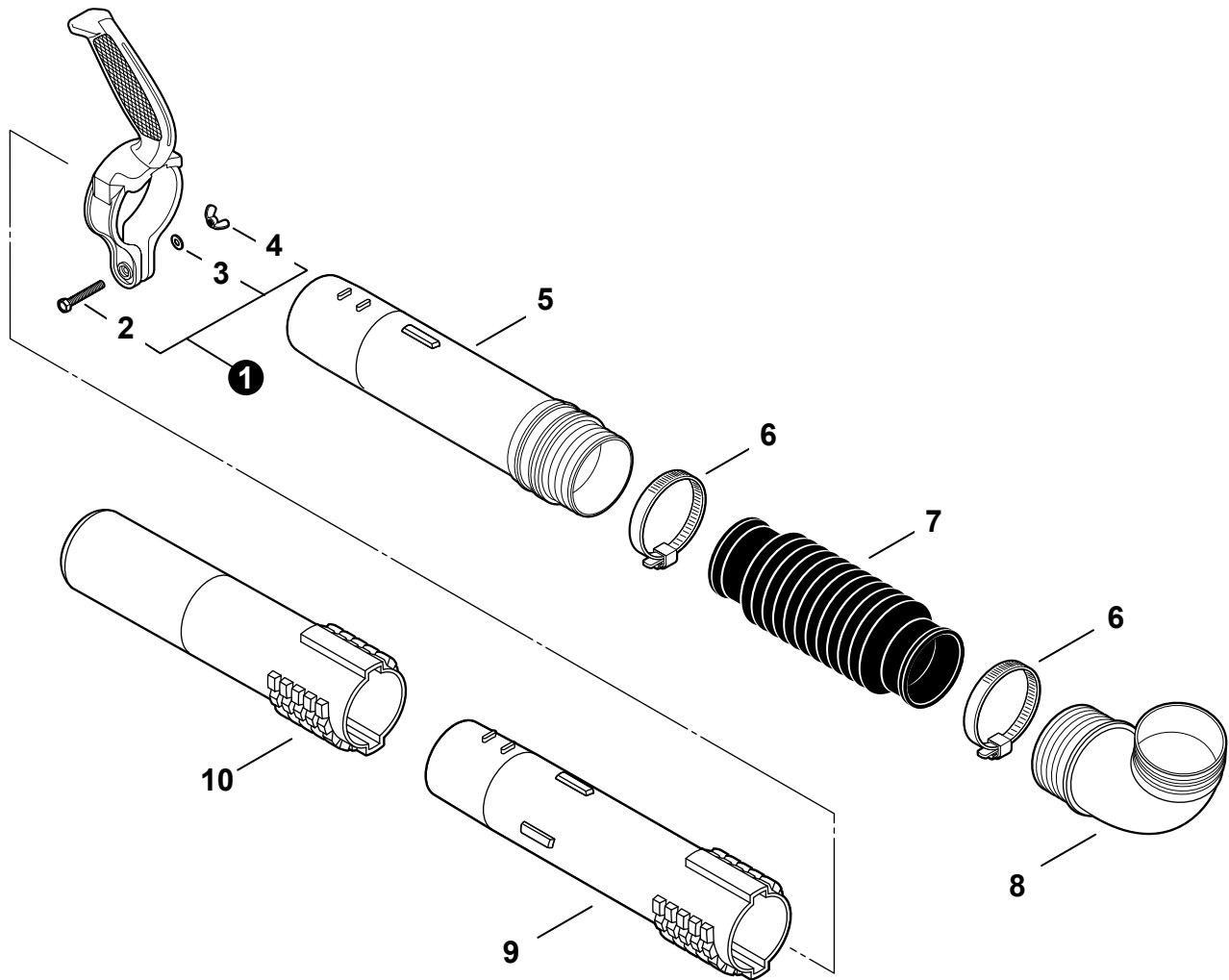

NO.	PART NUMBER	QTY.	DESCRIPTION	DESCRIPCIÓN
1	001106	1	HANDLE ASSY, PB LARGE	MONTAJE DE MANGO GRANDE
2	90010006045	1	+BOLT 6×45	+PERNO 6×45
3	90060000006	1	+WASHER 6.5×11.5×0.8	+ARANDELA 6.5×11.5×0.8
4	90052500006	1	+NUT, WING 6	+TUERCA MARIPOSA 6
5	E165000130	1	TUBE, BLOWER - SWIVEL	TUBO DEL SOPLADOR - GIRATORIO
6	V495000430	2	CLAMP 58.7MM / 82.5MM	ABRAZADERA 58.7MM / 82.5MM
7	E164000000	1	TUBE, BLOWER - FLEXIBLE	TUBO DEL SOPLADOR - FLEXIBLE
8	E160000111	1	TUBE, ELBOW	TUBO CODO
9	E165000141	1	TUBE, BLOWER - STRAIGHT	TUBO DEL SOPLADOR - RECTO
10	E165000171	1	TUBE, BLOWER - ROUND NOZZLE	TUBO DEL SOPLADOR - BOQUILLA REDONDA

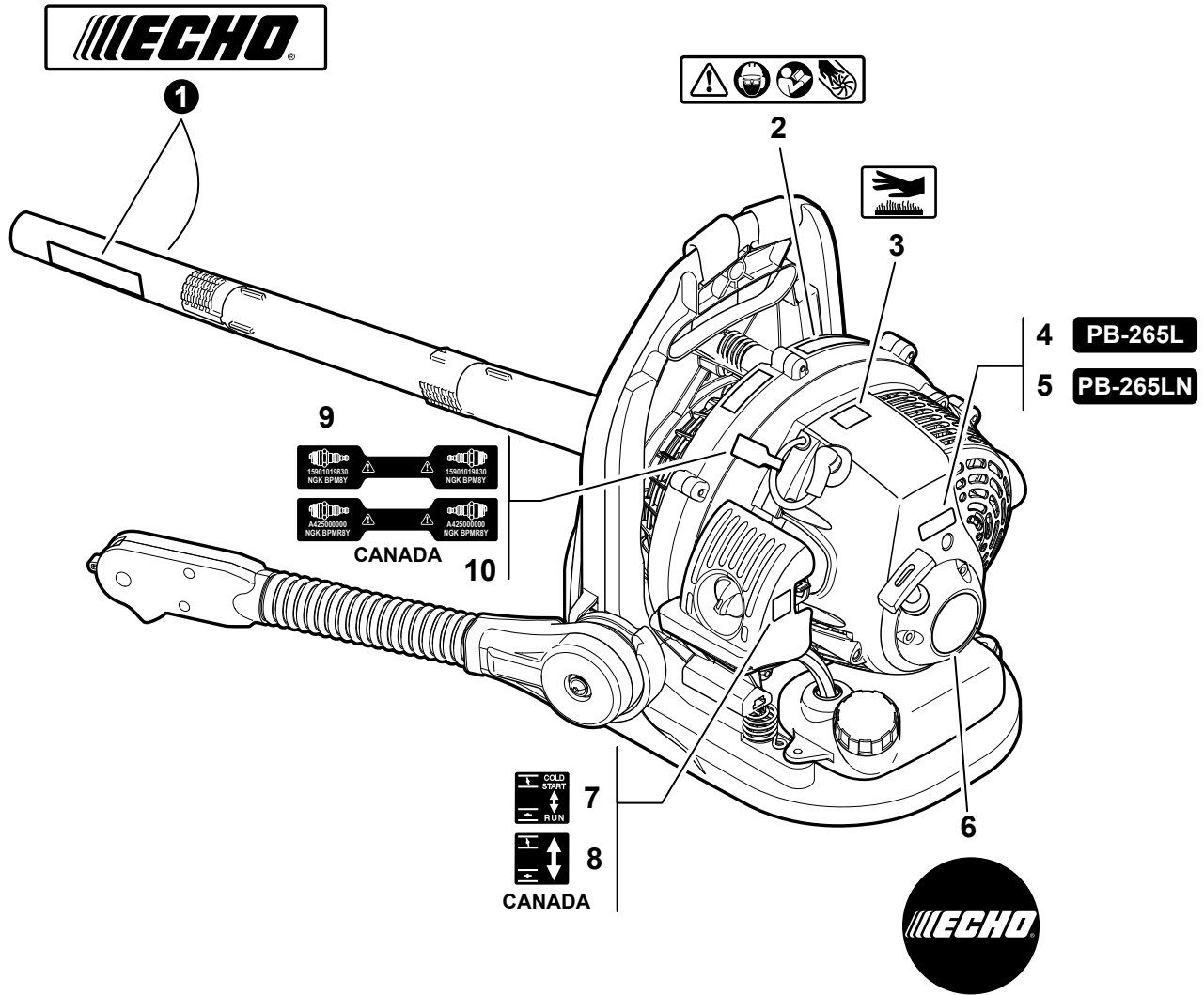

NO.	PART NUMBER	QTY.	DESCRIPTION	DESCRIPCIÓN
1	89011804262	2	LABEL, ECHO BLOWER TUBE	ETIQUETA DE ECHO PARA TUBO DEL SOPLADOR
2	X505002080	1	LABEL, CAUTION - ISO	ETIQUETA DE PRECAUCIÓN - ISO
3	X505002310	1	LABEL, CAUTION - HOT	ETIQUETA DE PRECAUCIÓN CALIENTE
4	X503007590	1	LABEL, MODEL	ETIQUETA MODELO
5	X503011560	1	LABEL - MODEL PB-265LN	ETIQUETA MODELO PB-265LN
6	X502000330	1	LABEL, ECHO	ETIQUETA ECHO
7	X506000080	1	LABEL, CHOKE	ETIQUETA DEL ESTRANGULADOR
8	X506000090	1	LABEL, CHOKE	ETIQUETA DEL ESTRANGULADOR
9	X532000671	1	LABEL, SPARK PLUG - BPM8Y	ETIQUETA DE BUJÍA BPM8Y
10	X532000720	1	LABEL, SPARK PLUG - BPM8Y	ETIQUETA DE BUJÍA BPM8Y

NO.	PART NUMBER	QTY.	DESCRIPTION	DESCRIPCIÓN
1	90014	1	PIPE, FUEL - REPOWER BULK 3x5mm BLACK	TUBO REPOWER AL POR MAYOR 3x5mm NEGRO
2	90017	1	PIPE, FUEL - REPOWER BULK 3x6mm CLEAR	TUBO REPOWER AL POR MAYOR 3x6mm TRANSPARENTE
3	99944440000	1	ROPE, STARTER - REPOWER BULK Ø3	CUERDA DEL ARRANCADOR REPOWER AL POR MAYOR
4	90154	1	TUNE-UP KIT - REPOWER	JUEGO DE PUESTA A PUNTO - REPOWER
5	A226000472	1	+FILTER, AIR - DOUBLE LAYER	+FILTRO DE AIRE - CAPA DOBLE
6	13120507320	1	+FILTER, FUEL	+FILTRO DE COMBUSTIBLE
7	A425000000	1	+SPARK PLUG - BPMR-8Y	+BUJÍA BPMR-8Y
8	90126	1	FUEL SYSTEM KIT - REPOWER	KIT DEL SISTEMA DE COMBUSTIBLE - REPOWER
9	A356000031	1	+VENT ASSY	+VÁLVULA DE RESPIRADERO
10	V490001240	3	+CLIP Ø6	+SUJETADOR Ø6
11	V471001200	1	+PIPE, FUEL 3x5x70 BLACK	+TUBO DE COMBUSTIBLE 3x5x70 NEGRO
12	V471003000	1	+PIPE, FUEL 3x6x125	+TUBO DE COMBUSTIBLE 3x6x125
13	V471003610	1	+PIPE, FUEL - 3x5x120 - BLACK	+TUBO DE COMBUSTIBLE 3x5x120 NEGRO
14	13211555930	1	+GROMMET, FUEL	+OJAL DE COMBUSTIBLE
15	V186000520	1	+CONNECTOR, PIPE Ø5xØ3.5	+CONECTOR DE TUBO Ø5xØ3.5
16	V471001210	1	+PIPE, FUEL 3x5x90 BLACK	+TUBO DE COMBUSTIBLE 3x5x90 NEGRO
17	13120507320	1	+FILTER, FUEL	+FILTRO DE COMBUSTIBLE
18	V107000150	1	+GASKET, FUEL CAP	+EMPAQUETADURA DEL TAPA DE COMBUSTIBLE
19	P021012380	1	GASKET KIT	JUEGO DE EMPAQUETADURA
20	V100000190	1	+GASKET, CYLINDER	+EMPAQUETADURA DE CILINDRO
21	10024242030	1	+GASKET, CRANKCASE	+EMPAQUETADURA DE CÁRTER
22	13001013410	1	+GASKET, CARBURETOR	+EMPAQUETADURA DE CARBURADOR
23	V103000300	1	+GASKET, INTAKE	+EMPAQUETADURA DE ADMISIÓN
24	13001642031	1	+GASKET, INTAKE	+EMPAQUETADURA DE ADMISIÓN
25	V104000750	1	+HEAT SHIELD, EXHAUST	+PROTECTOR TÉRMICO DEL ESCAPE
26	V104000840	1	+GASKET, EXHAUST	+EMPAQUETADURA DE ESCAPE