

ECHO

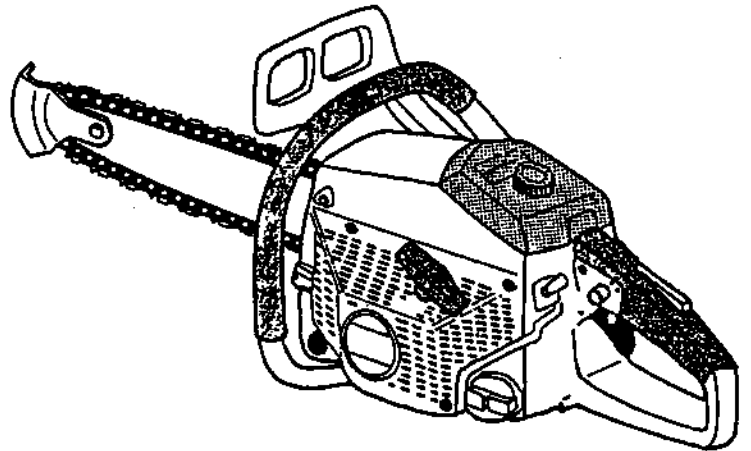

OPERATOR'S MANUAL

ECHO CHAIN SAW

CS-5000 TYPE 1-E



898611-39830
X750317-2200

CAUTION

Read Rules for Safe Operation
and Instructions Carefully

RULES FOR SAFE OPERATION

A. Kickback Safety Precaution for Chain Saw Users

WARNING!

KICKBACK may occur when the nose or tip of the guide bar touches an object, or when the wood closes in and pinches the saw chain in the cut.

Tip contact in some cases may cause a lightning fast reverse REACTION, Kicking the guide bar up and back towards the operator. pinching the saw chain along the top of the guide bar may push the guide bar rapidly back towards the operator. Either of these reactions may cause you to lose control of the saw which could result in serious personal injury.

Do not rely exclusively upon the safety devices built into your saw. As a chain saw user, you should take several steps to keep your cutting jobs free from accident or injury.

1. With a basic understanding of kickback, you can reduce or eliminate the element of surprise. Sudden surprise contributes to accidents.
2. Keep a good firm grip on the saw with both hands, the right hand on the rear handle, and the left hand on the front handle, when the engine is running. Use a firm grip with thumbs and fingers encircling the chain saw handles. A firm grip will help you reduce kickback and maintain control of the saw. Don't let go.
3. Make sure that the area in which you are cutting is free from obstructions. Do not let the nose of the guide bar contact a log, branch, or any other obstruction which could be hit while you are operating the saw.
4. Cut at high engine speeds.
5. Do not overreach or cut above shoulder height.
6. Follow manufacturer's sharpening and maintenance instructions for the saw chain.
7. Only use replacement bars and chains specified by the manufacturer or the equivalent.

B. Other Safety Precautions

1. Do not operate a chain saw with one hand! Serious injury to the operator, helpers, bystanders, or any combination of these persons may result from one-handed operation. A chain saw is intended for two-handed use.
2. Do not operate a chain saw when you are fatigued.
3. Use safety footwear; snug-fitting clothing; protective gloves; and eye, hearing, and head protection devices.
4. Use caution when handling fuel. Move the chain saw at least 3 m(10 feet) from the fueling point before starting the engine.
5. Do not allow other persons to be near the chain saw when starting or cutting with the chain saw. Keep bystanders and animals out of the work area.
6. Do not start cutting until you have a clear work area, secure footing, and a planned retreat path from the falling tree.

7. Keep all parts of your body away from the saw chain when the engine is running.
8. Before you start the engine, make sure that the saw chain is not contacting anything.
9. Carry the chain saw with the engine stopped, the guide bar and saw chain to the rear, and the muffler away from your body.
10. Do not operate a chain saw that is damaged, improperly adjusted, or not completely and securely assembled. Be sure that the saw chain stops moving when the throttle control trigger is released.
11. Shut off the engine before setting the chain saw down.
12. Use extreme caution when cutting small size brush and saplings because slender material may catch the saw chain and be whipped toward you or pull you off balance.
13. When cutting a limb that is under tension, be alert for springback so that you will not be struck when the tension in the wood fibers is released.
14. Keep the handles dry, clean, and free of oil or fuel mixture.
15. Operate the chain saw only in well-ventilated areas.
16. Do not operate a chain saw in a tree unless you have been specifically trained to do so.
17. All chain saw service, other than the items listed in the operator's manual maintenance instructions, should be performed by competent chain saw service personnel. (For example, if improper tools are used to remove the flywheel or if an improper tool is used to hold the flywheel in order to remove the clutch, structural damage to the flywheel could occur and could subsequently cause the flywheel to burst.)
18. When transporting your chain saw, use the appropriate guide bar scabbard.
19. Spark arrester mufflers approved to SAE Standard J335 are Standard on ECHO Chain saws to reduce the possibility of forest fires. Do not operate the chain saw with a loose or defective muffler. Do not remove the spark arrester screen.

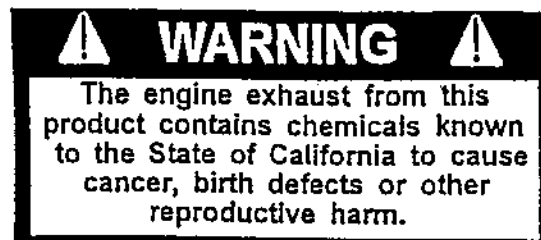

CONTENTS

	Page
Rules for Safe Operation	1
Technical Data	3
Nomenclature of Parts	4
Preparation for Use	5
Operation	6
Cutting Instruction	9
Maintenance and Care	13
Setting the Saw Chain	16
Chain and Guide Bar Combinations	18
Trouble Shooting	19
Storage	20
Chain Brake	21

TECHNICAL DATA

			C S - 5000 TYPE 1 - E
Dimension	L × W × H	mm	410 × 225 × 280
		inch	16.1 × 8.9 × 11.0
Masses	Power head, dry	kg	5.0 (11.1 lbs) Without chain and guide bar
Engine	Type	mL(cm ³)	Air cooled two stroke single cylinder
	Displacement		49.3 (3.01 cu.in.)
	Carburetor		Diaphragm type
	Magneto		Flywheel magneto : CDI system
	Spark plug		CHAMPION CJ-6Y or NGK BPM 8Y
	Starter		Recoil starter
Power transmission	Automatic centrifugal clutch		
Fuel	Mixture ratio		50 : 1 ratio with ECHO brand two-stroke oil. 89 octane unleaded. Do not use fuel containing methyl alcohol, more than 10% ethyl alcohol or 15% MTBE.
	Tank capacity	L	0.47 (15.9 Fl.oz.us)
Oil	Bar and chain	L	ECHO bar and chain oil (or motor oil)
	Tank capacity		0.29 (9.8 Fl.oz.us)
Guide bar and saw chain			See page 18 for Bar and Chain technical data.
	Lubrication		Adjustable automatic oil pump
Standard features			Front hand guard, Rear hand guard Anti-vibration device, spiked bumper Throttle control lockout, Chain brake Chain catcher, Spark arrester muffler

★Technical data subject to change without notice.

NOMENCLATURE OF PARTS

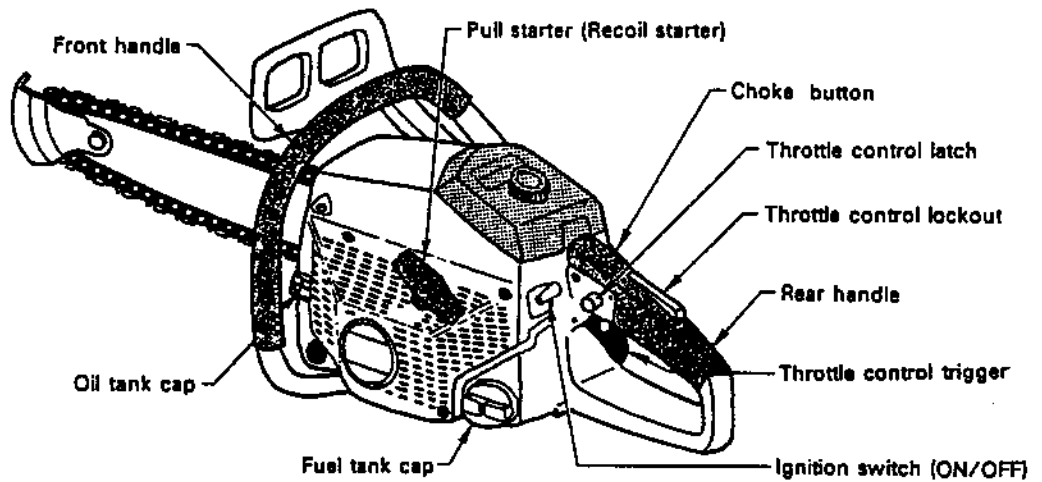
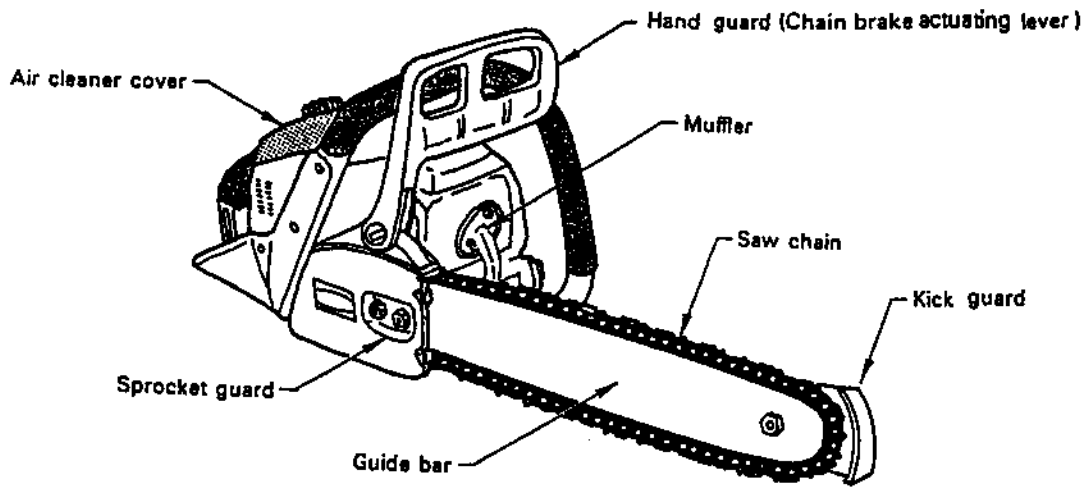

PREPARATION FOR USE

MOUNTING GUIDE BAR AND CHAIN (see illustration)

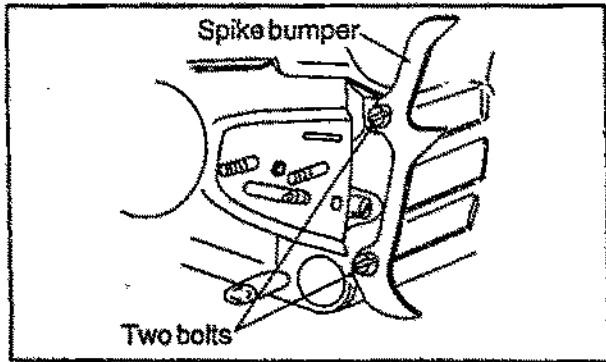

- Remove the sprocket guard with outer side plate, leaving the inner side plate in position.
- Install the spike bumper on the front of machine. (Use two bolts.)

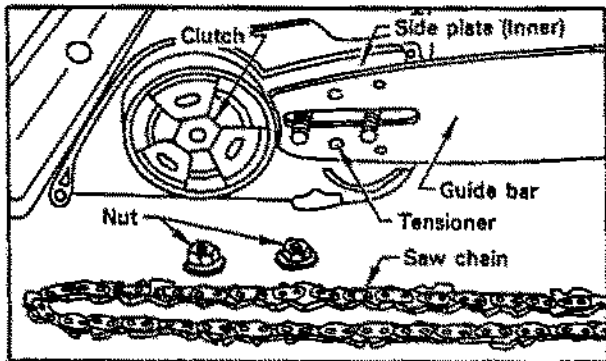

- Mount the guide bar ensuring that the chain tensioner fits in the hole provided.
- Holding the bar in this position, feed the chain around the sprocket and into the guide bar groove.
- Fit sprocket guard and nuts. Secure the nuts hand tight.

NOTES

1. The inner side plate is fitted with a narrow lubricating oil slot at the top.
2. The guide bar must be installed with the smaller nose radius at the top.
3. Ensure that the chain is installed with the cutters directed forward on the top of the bar.

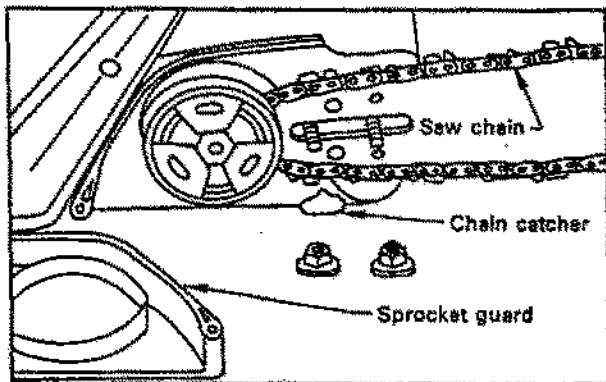

WARNING

KICKBACK IS DANGEROUS. The low kick asymmetrical bar must be mounted with the reduced radius section of the nose on top as illustrated. Incorrect installation may result in serious or fatal injury.

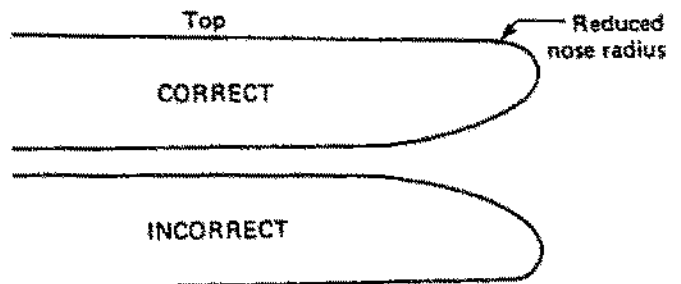

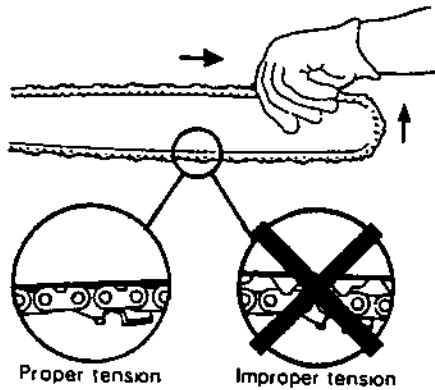
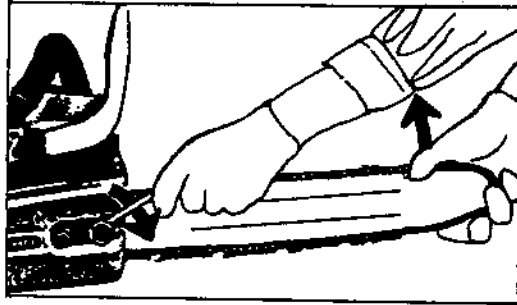
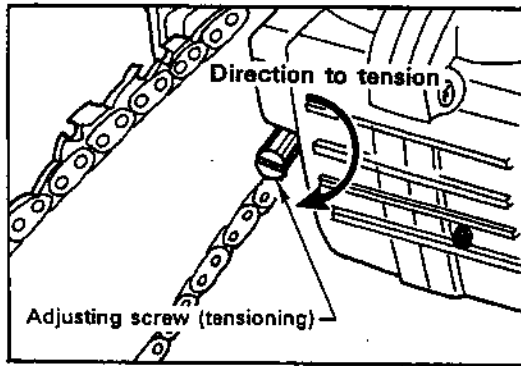

ADJUSTMENT, CHAIN TENSION

- Turn the adjuster screw clockwise until the chain touches the bottom of the bar.
- Hold the bar nose up and tighten the chain until there is no clearance between the bar and chain tie straps.
- Tighten both nuts with the bar nose held up to eliminate clearance.
- Pull the chain around the bar by hand. Loosen the adjustment if you feel tight spots.
- Start the engine and run at low speed. Stop and readjust if necessary.

CAUTION

1. All adjustment should be made cold.
2. Always wear gloves when working on chain.
3. Do not operate with a loose chain

OPERATION

FUEL STATEMENT

GASOLINE-Use 89 Octane[$\frac{R+M}{2}$] gasoline or gasohol known to be good quality. Gasohol may contain maximum 10% ethyl (grain) alcohol or 15% MTBE (methyltertiary-butyl ether). Gasohol containing methyl(wood) alcohol is not approved.

TWO-STROKE OIL - Use 50 : 1 two-stroke ECHO oil only. Engine problems due to inadequate lubrication caused by failure to use 50 : 1 ECHO oil will void the warranty on your ECHO product.

MIXING - Mix oil and gasoline/gasohol according to their instructions on the ECHO oil label.

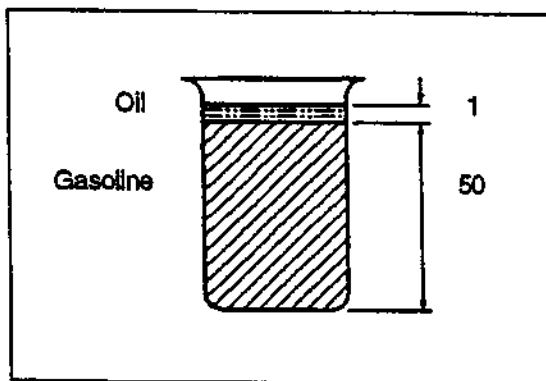

50 : 1

(US)		(METRIC)	
GAS	OIL	GAS	OIL
Gal.	Fl.oz.	L	mL.
1	2.6	4	80
2	5.1	8	160
5	12.8	20	400

IMPORTANT

Stored fuel ages. Do not mix more fuel than you expect to use in thirty (30) days, ninety (90) days when a fuel stabilizer is added. Stored two-stroke fuel may separate. ALWAYS shake fuel container thoroughly before each use.

CAUTION

Whenever opening up the fuel tank, always loosen the cap very slowly and wait for the tank pressure to be equalized before removing the cap.

CAP INDICATION

Fuel/oil tanks are indicated by the following illustrations on the caps

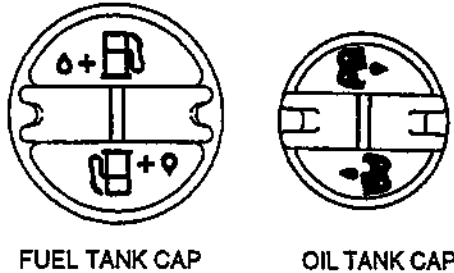

CHAIN LUBRICANT

Proper lubrication of the chain while in operation reduces friction between the chain and the guide bar to a minimum and assures a longer service life.

- Use ECHO bar and chain oil of high quality for this purpose.
- Do not use used or reclaimed oil to avoid various oiler problems.
- When refueling, also refill chain oil.

STARTING

Check for loose nuts and screws on the handle, fan cover, etc., each time before using the chain saw.

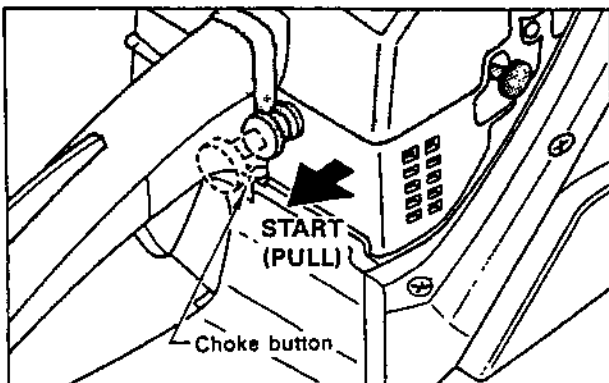
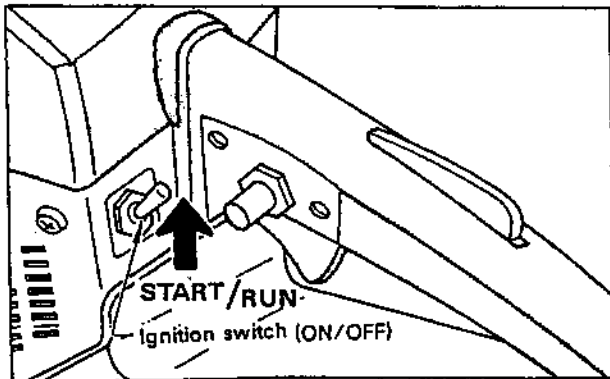

WHEN THE ENGINE IS COLD

- Fill the fuel tank with fuel mixture.
 - Fill the chain oil tank with lubricant.
 - Turn ignition switch upward.
 - Pull choke fully.
-
- Make sure bar and chain are in the clear while starting the saw.
 - Securely hold the saw as shown and pull starter handle several times until first firing sound.

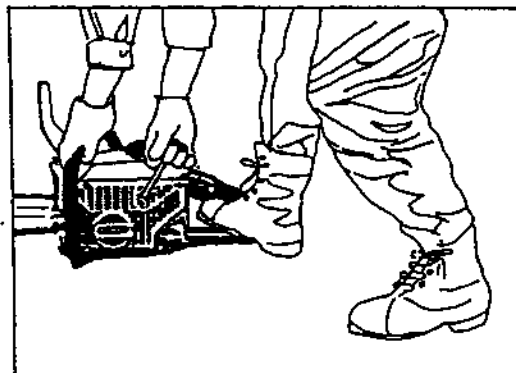

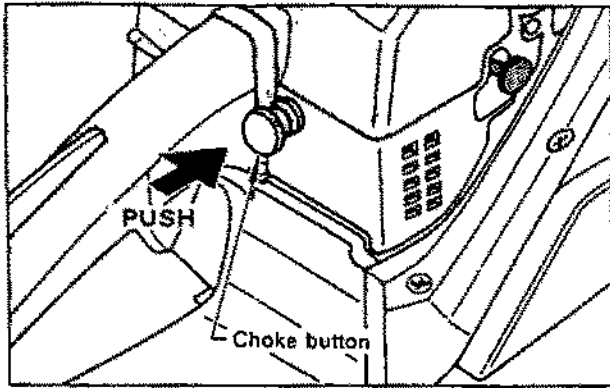

- Push choke all the way in.
- Pull starter handle again.

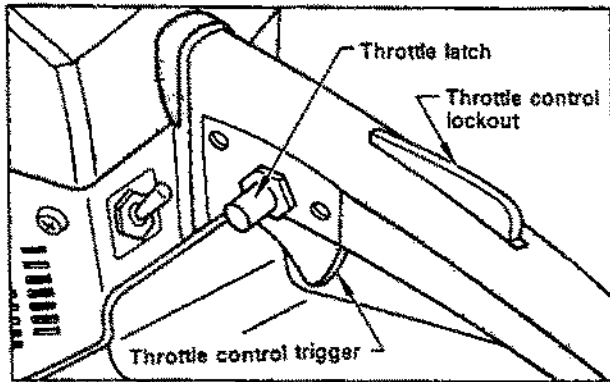

WHEN THE ENGINE IS HARD TO START

- Press lock down while grasping throttle trigger and push in latch as shown.
- Pull starter handle.
- When engine starts, immediately pull throttle trigger up, to release the latch.

CAUTION

Clutch engages and chain will rotate when engine is started with throttle latch engaged.
After engine starts, release throttle trigger to idle engine.
Never use the latch for cutting.
Use it only when starting the engine.

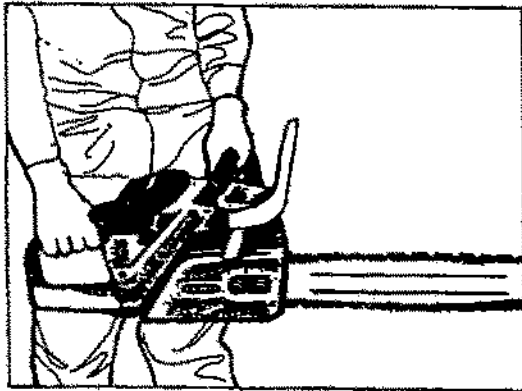

WHEN THE ENGINE IS WARM

- Confirm fuel and chain oil in the tanks.
- Turn ignition switch upward.
- Pull starter handle.
- Choke may be used if necessary but be sure to push it back on first firing sound.

RUNNING

- When engine starts, keep idling for a few minutes.
- Pull throttle trigger gradually and increase revolution of the engine.
- The chain starts moving when the engine reaches to 3,600 rpm approximately.
- Confirm proper acceleration and lubrication of chain and bar.
- Do not run the engine at high speed without load, i.e. out of cut longer than 4 second.

STOPPING

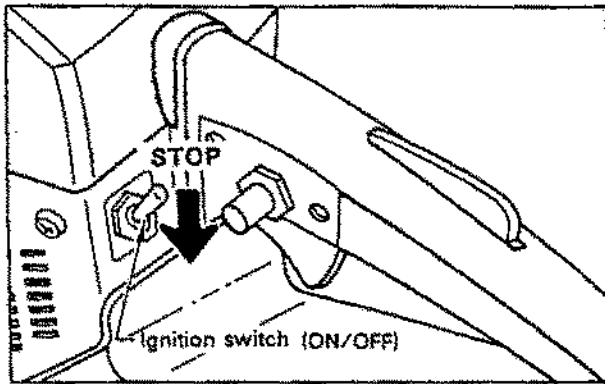

- Release throttle trigger and turn ignition switch down.

[NOTE]

When engine does not stop, pull choke all the way out to stop engine.
Check and repair ignition switch before starting the engine again.

CUTTING INSTRUCTION

GENERAL

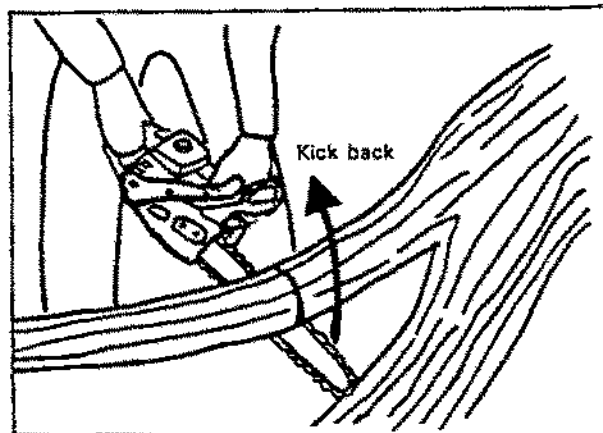
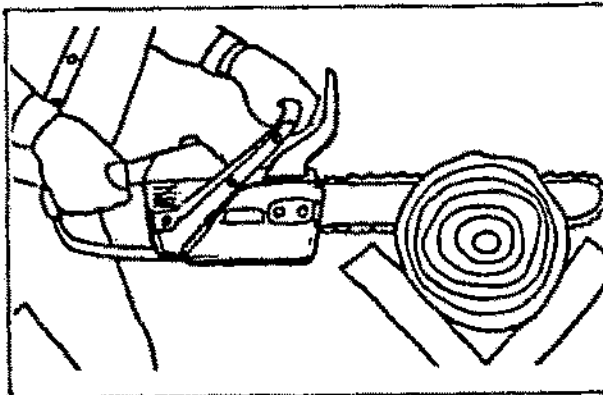
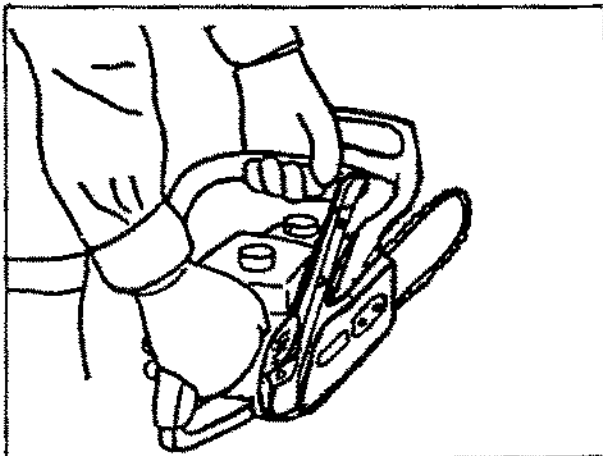

[NOTE]

Read the ECHO "CHAIN SAW SAFETY MANUAL" included with your chain saw for additional cutting and safety instructions.

In all circumstances the operation of the chain saw is a one-man job. It is difficult at times to take care for your own safety, so don't assume the responsibility for a helper as well. After you have learned the basic techniques of using the saw, your best aid will be your own good common sense . . .

The accepted way to hold the saw is to stand to the left of the saw with your left hand on the front handlebar and your right hand on the rear handle so you can operate the throttle trigger with your right index finger.

Before attempting to fell a tree, cut some small logs or limbs. Become thoroughly familiar with the controls and the responses of the saw.

Start the engine, see that it is running properly. Squeeze the trigger to open the throttle wide open and start the cut. If the chain is properly sharpened, the cutting should be relatively effortless. It is not necessary to press down hard to make the saw cut. Pushing the saw too hard will slow the engine and cutting will actually be more difficult.

Some material may adversely affect the housings of your Echo chain saw.

(Example palm Tree Acid, fertilizer etc.) To avoid housing deterioration, carefully remove all packed saw dust around clutch and guide bar area and wash with water.

CAUTION

Do not let the tip of the bar touch anything while the engine is running. At cutting speed the chain is moving, at a high rate of speed. Should the tip contact a limb or log while the chain is moving, the tip will be pushed upward with considerable force. This is known as kick-back. Avoid it!

SEE OPERATOR'S MANUAL INSERT FOR INSTALLATION AND USE WITH THE KICK GUARD.

FELLING A TREE

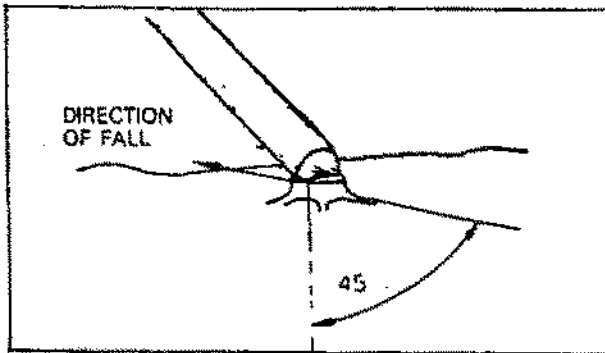

A falling tree can seriously damage anything it may hit — a car, a house, a fence, a powerline, or another tree. There are ways to make a tree fall where you want it, so first decide where that is!

Before cutting, clear the area around the tree. You will need good footing while working and you should be able to work the saw without hitting any obstacles. Next, select a path of retreat. When the tree begins to fall you should retreat away from the direction of fall at a 45 degree angle to avoid the trunk kicking back over the stump.

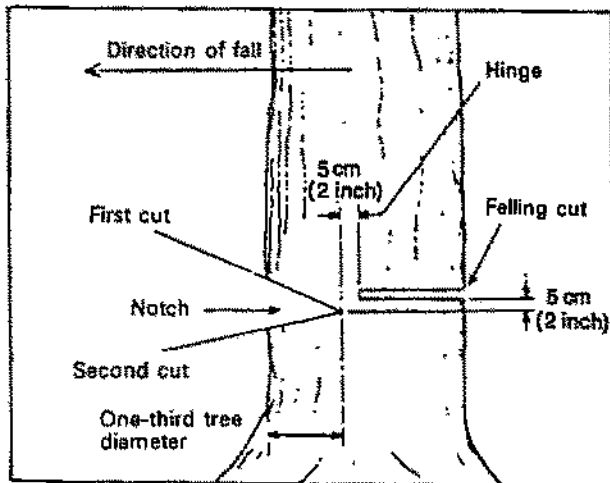

Begin the cut on the side to which the tree is to fall. Cut a notch about 1/3 of the way into the tree as shown. The position of this notch is important since the tree will try to fall "into" the notch. The felling out is made on the side opposite the notch and at a level about 5 cm (2 inch) above the bottom of the notch. Do not try to cut through to the notch with the felling cut. The remaining wood between the notch cut and felling cut (about 5 cm ; 2 inch) will act as a hinge when the tree falls, guiding it in the desired direction. When the tree starts to fall, kill the engine, place the saw on the ground and make your retreat quickly.

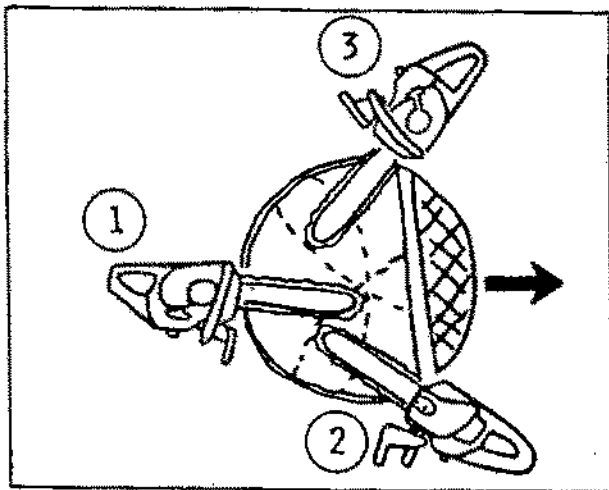

To fell big trees with a diameter exceeding twice the bar length, start the notching cuts from one side and draw the saw through to the other side of the notch. Start the back cut on one side of the tree, pivoting the saw through to form the desired hinge on that side.

Then remove the saw for the second cut. Insert the saw in the first cut, very carefully so as not to cause kickback. The final cut is made by drawing the saw forward in the cut to reach the hinge.

SEE OPERATOR'S MANUAL INSERT FOR INSTALLATION AND USE WITH THE KICK GUARD.

LIMBING

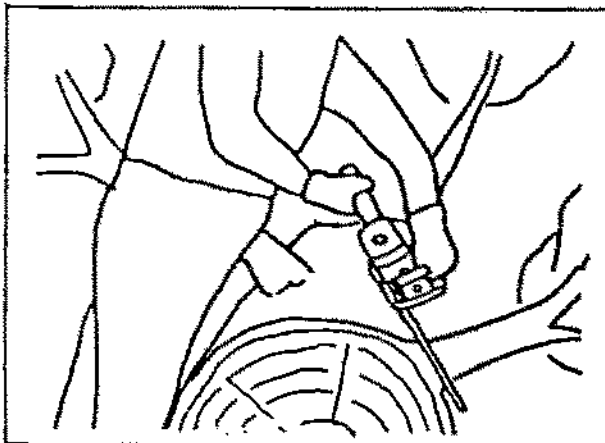

Limbing a fallen tree is much the same as bucking. Never limb on the tree that you are standing. When limbing, caution is the word. Be careful of the tip touching other limbs. Always use both hands.

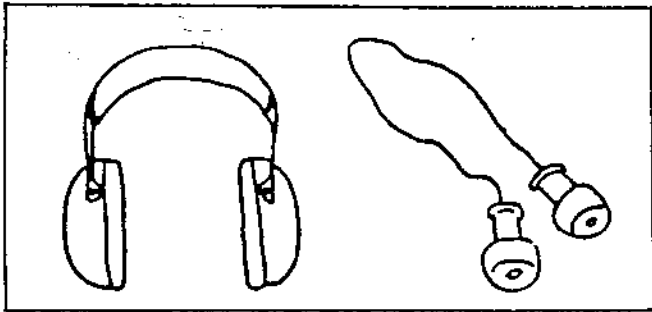

CAUTION

Wear suitable hearing protective device such as earmuffs or earplugs to protect against objectionable or uncomfortable loud noises.

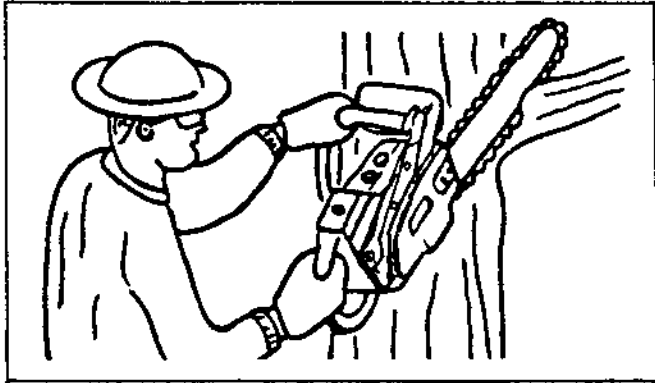

Don't cut with the saw overhead or the bar in a vertical position. If the saw should kick back you may not have good enough control to prevent possible injury.

BUCKING

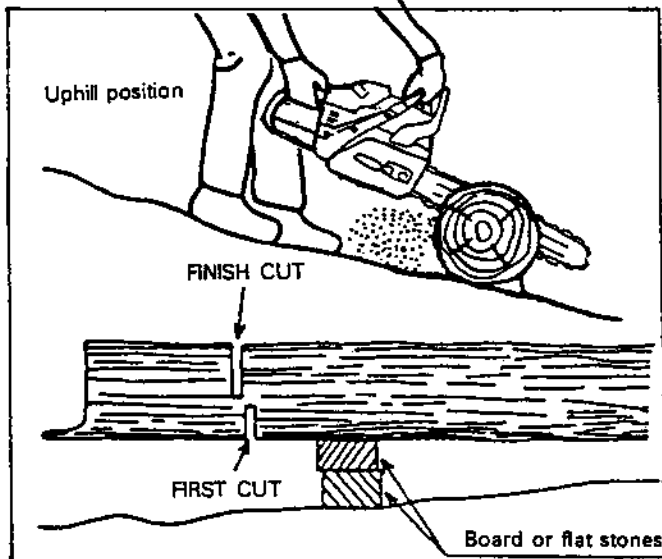

Bucking is the sawing of a log or fallen tree into smaller pieces. There are a few basic rules which apply to all bucking operations.

Keep both hands on the handles at all times.

Support logs if possible.

When cutting on a slope or hillside, always stand uphill.

Keep in mind that the wood is heavy and that it will bend and pinch the saw if improperly supported.

The trunk will weaken at the point where you make the cut unless the tree is lying on perfectly flat ground or supported as shown.

If you make the cut with the tree on the ground, don't let the saw's chain dig into the earth; it is harmful for the saw, and you stand a good chance of being struck by flying debris. To cut the trunk, use the bucking and two-cut sequence shown. The first cut should be no deeper than one-third the trunk diameter.

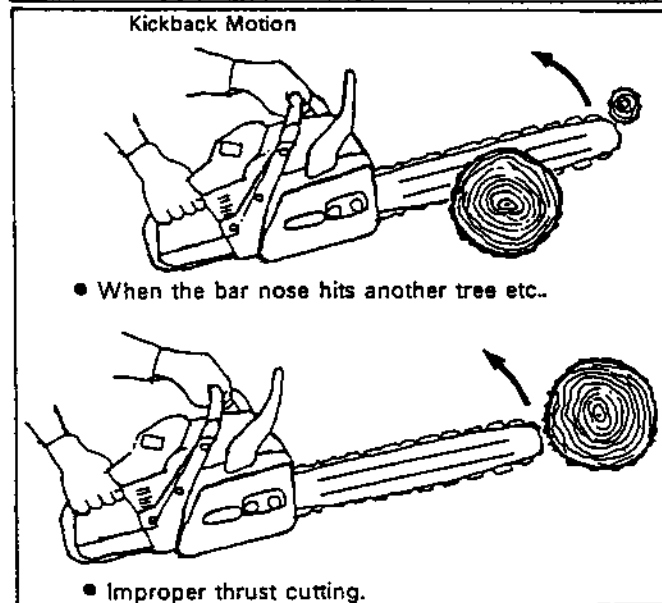

WARNING: KICKBACK IS DANGEROUS

- Kickback is generated when rotation of the chain is arrested for some reason. The most dangerous effect of this action occurs when the nose of the bar contacts another object, the chain is momentarily stopped and all the energy of engine throws the bar upwards and backwards towards the operator.
- The chain saw industry and government agencies have attempted to prescribe various safety devices, but the best protection is to avoid kickback.
- Comply with the Safety Precautions as listed on page 1 of this manual.

SEE OPERATOR'S MANUAL INSERT FOR INSTALLATION AND USE WITH THE KICK GUARD.

INFORMATION

Kickback Safety Features

The following features are recommended for this model as Kickback Safety Features.

- Double Guard Low Kick Type Guide Bar or Asymmetrical Low Kick Type Guide Bar

Note: Your saw can be equipped with either of these bars.

Double Guard Bar

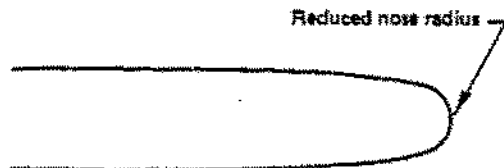

Asymmetrical Bar

The asymmetrical low kick type guide bar must be mounted with the reduced radius section of nose on top as illustrated. Incorrect installation will result in increased kickback potential.

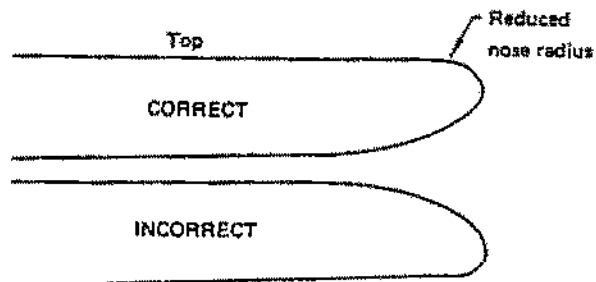

NOTE:

Replacement Guide Bars.

The following guide bars may be considered to have equivalent kickback energy.

- Sprocket nose guide bars of the same length and nose radius, same pitch and having the same number of teeth.
- A hard nose guide bar having the same length and nose radius as a sprocket nose bar.

- Low Kick Guard Link Type Saw Chain

The low kick guard link chain must be maintained correctly, follow instruction "SETTING THE CHAIN" in operator's manual.

- Front Hand Guard

The front hand guard must be installed correctly and kept in good condition.

- Chain Brake

The chain brake is available as a standard feature of the P-type model.

Chain brake must be maintained correctly, follow instruction "CORRECT USE OF CHAIN BRAKE" in operator's manual.

CAUTION!!

The consequences of using improper replacement components and of removing safety devices may result in serious or fatal injury.

MAINTENANCE AND CARE

CARBURETOR

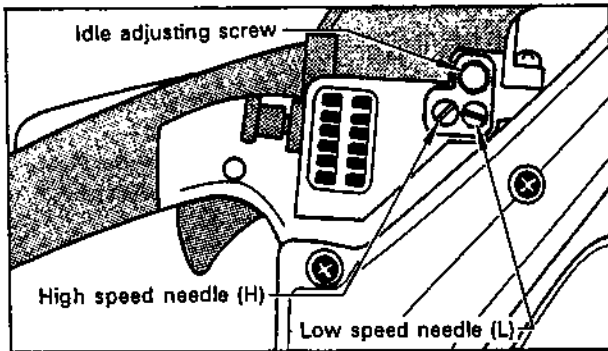

- The carburetor is equipped with "H" (High Speed Needle) and "L" (Low Speed Needle) needle adjustment limiters that prevent settings outside acceptable limits.

1. Before adjusting carburetor clean or replace air filter and muffler, "Spark Arrestor Screen".
2. Make sure the cutting attachment such as bar and chain are properly adjusted.
3. Start engine and run several minutes to bring to operating temperature. Flash choke twice during warm-up to clear any air from the fuel system.
4. Stop engine. Turn "H" speed needle CCW to stop. Turn "L" speed needle midway between full CW stop and CCW stop.
5. Idle Speed Adjustment
 - Start engine, turn "idle" speed adjustment screw CW (clockwise) until the saw chain begins to turn, then turn screw out CCW (counterclockwise) until the saw chain stops turning. Turn screw out, CCW, an additional 1/4 turn.

WARNING  **DANGER**
CUTTING ATTACHMENT MUST NOT TURN OR MOVE WHEN UNIT IS IDLING.

6. Accelerate to full throttle for 2-3 seconds to clear any excess fuel in the engine, then return to idle. Accelerate engine to full throttle to check for smooth transition from idle to high speed. If engine hesitates turn "L" needle CCW 1/8 turn and repeat acceleration. Continue adjustment until smooth acceleration results.
7. Check idle speed and reset if necessary as described in item 5. If a tachometer is available idle speed should be set as specified in the Operator's Manual.

CAUTION
When starting, idling adjustment speed should be adjusted not to rotate the saw chain. Correct idle speed is adjusted 2900 to 3100 r/min. Or 1/4 turn counter clockwise from the point the chain stops moving. When there is some trouble with the carburetor, refer to your distributor or dealer.

AIR FILTER

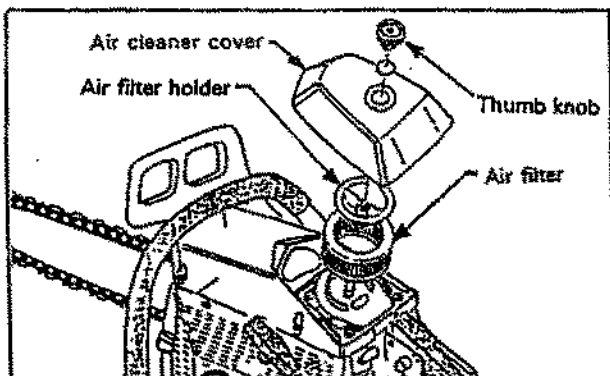

- Check before every use.
- Loosen thumb knob and remove the air filter cover.
- Loosen air filter holder and remove the air filter.
- Brush or blow off lightly.

FUEL STRAINER

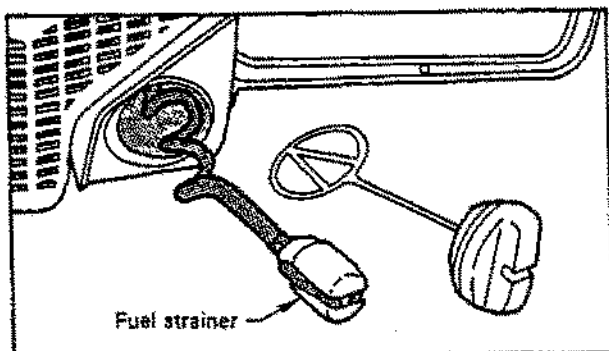

- Check periodically.
 - Do not allow dust to enter fuel tank.
 - Clogged strainer will cause difficulty in starting engine or abnormalities in engine performance.
 - Pick up the fuel strainer through fuel inlet port with a piece of steel wire of the like.
 - When the strainer is dirty, replace it.
 - When the inside of the fuel tank is dirty, it can be cleaned by rinsing the tank out with suitable cleaning fluid.

GUIDE BAR

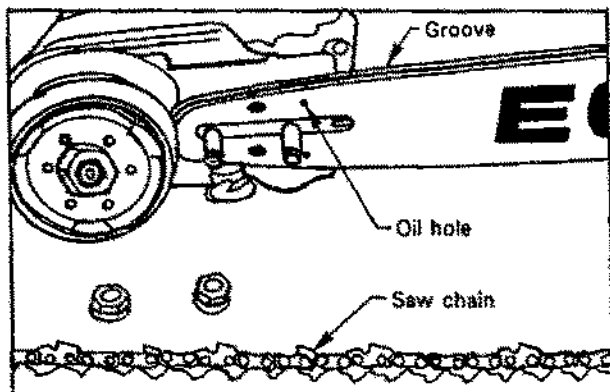

- Clean before using.
 - Clean the groove of the guide bar with, for example, a small screw driver.
 - Clean oil holes with a wire.
- Reverse guide bar periodically.
- Clean sprocket, clutch and bar mount area before installing.

SPROCKET

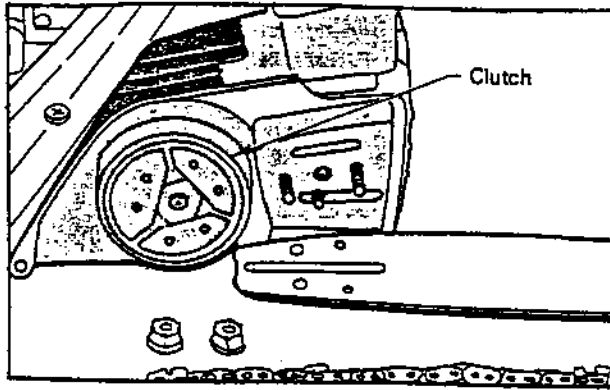

- The damaged sprocket will cause premature damage or wear of saw chain.
 - When the sprocket has worn out 0.5 mm (.020 in.) or more, replace it.
- Check sprocket when you install new chain. Replace it if worn.

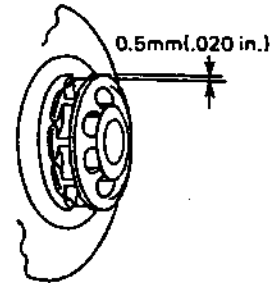

AUTOMATIC OILER

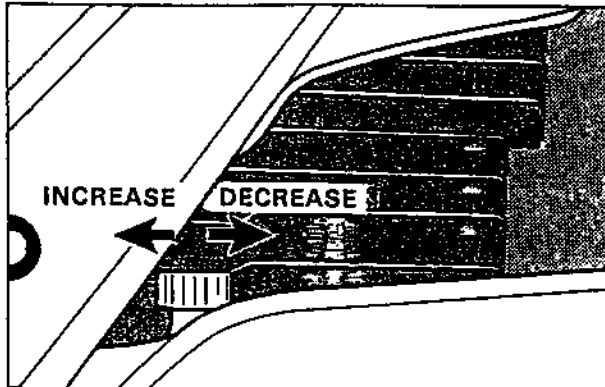

- The discharge volume of the automatic oiler is adjusted to 8 mL/min. approx. at 7000 r/min, prior to shipment from factory.
 - To increase the delivery volume, turn the adjusting screw counterclockwise. When the screw touches stopper and stops, this position indicates maximum discharge volume. (15–16 mL/min. 7,000 r/min)
 - Do not turn the adjusting screw beyond the max. or min. limit of volume adjustment.

OIL STRAINER

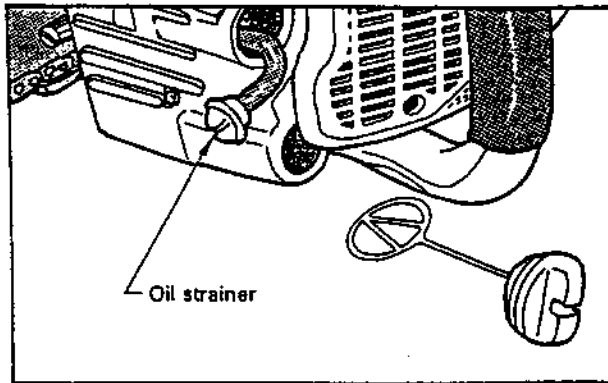

- Check periodically.
 - Do not allow dust to enter into oil tank.
 - Clogged oil strainer will affect the normal lubricating system.
 - Pick it up through oil filling hole with a piece of steel wire or the like.
 - If the strainer is dirty, wash it in gasoline.
 - When the inside of the tank gets dirty, it can be cleaned by rinsing the tank out with gasoline.

SPARK PLUG

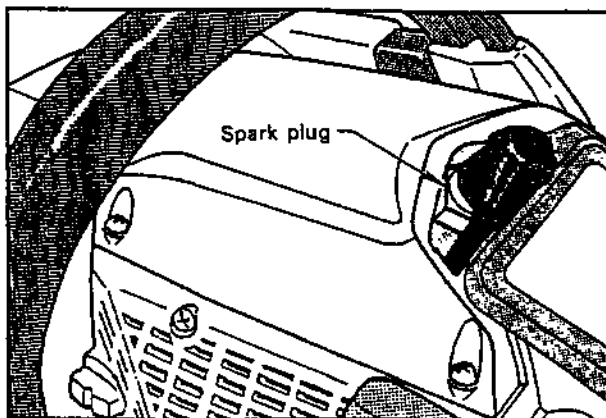

- Check periodically.
 - The standard spark gap is 0.6–0.7 mm (.024–.028 in.).
 - Correct the spark gap if it is wider or narrower than the standard gap.
- Fastening torque = 14.2–15.2 N·m (125–135 in·lb).

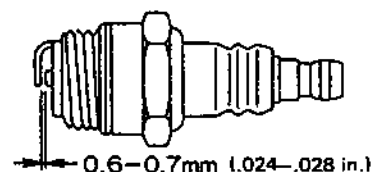

CYLINDER FIN

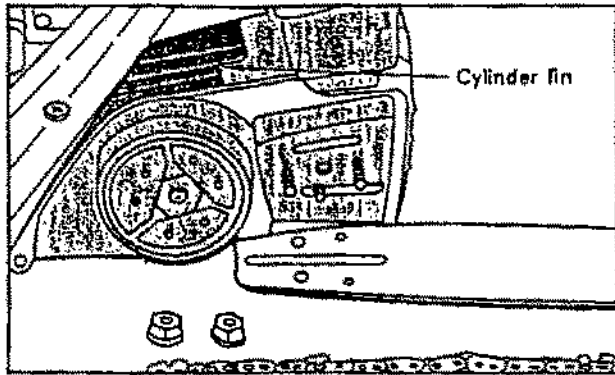

- The unit has CDI (Capacitor Discharge Ignition) magneto system, which does not require adjustment of ignition timing and the contact breaker point gap.
- Check for secure (tight) wire connections.

CYLINDER FIN

- Check periodically.
- Clogged fins will result in poor engine cooling.
- Remove dirt and dust from between fins to let cooling air pass easily.

SETTING THE SAW CHAIN

NOMENCLATURE OF PARTS

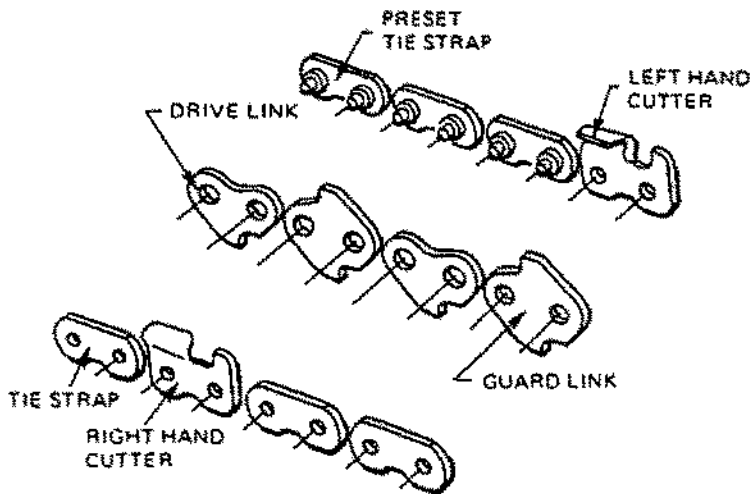

- Guard links reduce the potential of kickback.

CUTTER PART NAMES

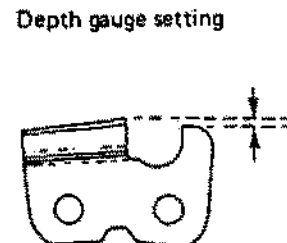
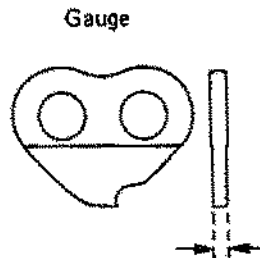
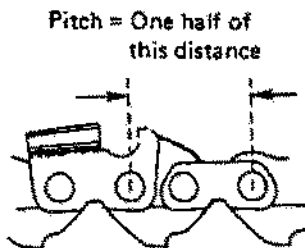
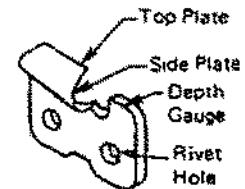

- Gauge is thickness of drive links.
- Depth gauge controls the cutting depth.

Important points for proper maintenance of saw chain:

- Keep the cutters sharp at all times.
- Keep the left and the right cutters properly aligned.
 - Please note that blunt or irregular cutters will result in poor cutting performance, increased vibration of chains and premature breakage of the saw chain.
- Drive link serves to remove sawdust from the groove of the guide bar. Therefore, keep the lower edge of the drive link, indicated by the arrow, sharp.

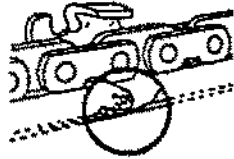

- When setting of the chain is finished, soak it in oil and wash away filings completely before using.
- When chain has been filed on the bar, supply sufficient oil to it, rotate the chain slowly to wash away the filings before using again.
- If the chain saw is operated with filings clogged in the groove, the saw chain and the guide bar will be damaged prematurely.
- If the saw chain becomes soiled with resin, for instance, clean it with kerosene and soak it in oil.
- For setting saw chain, round file (4.5 mm dia 11/64 inch) and flat file are used.
- To keep correct position and correct angle, use the file holder (Sure Sharp).
 - Round file (P-No. 897 510-8153 0) and flat file (P-No. 897 511-0023 0) are optional.
 - Inquire about the file holder, if desired.

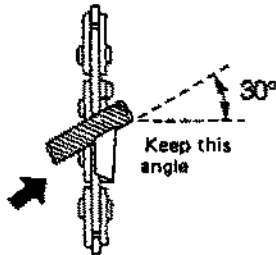

PUSH FILE AS SHOWN



HOLD FILE HOLDER LEVEL

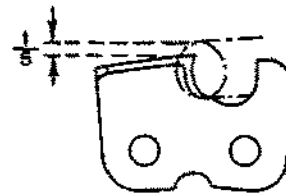

ONE FIFTH OF FILE DIAMETER REMAINS ABOVE CUTTER EDGE

- Place the depth gauge tool firmly on guide bar so that depth gauge protrudes. Then file top of depth gauge with flat file until flat with top of the depth gauge tool.
 - Be sure to round off the front edge of the depth gauge.

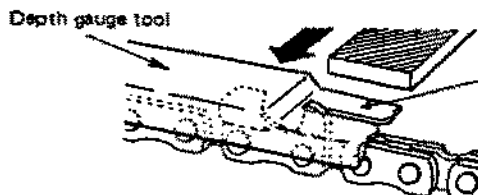

- Properly filed cutters are shown below.

(Top plate angle) (Side plate angle) (Top plate cutting angle) (Depth gauge)

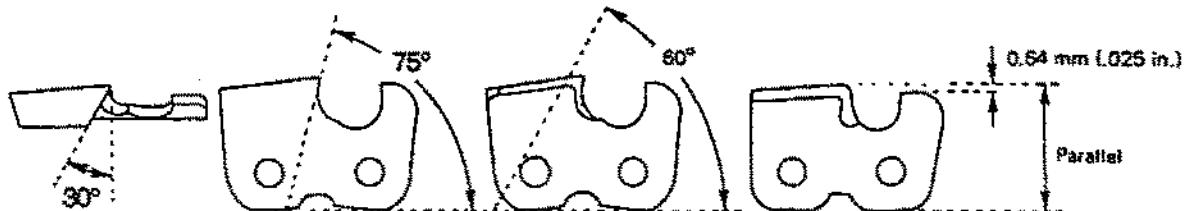

[NOTE]

These angles are referred to as Oregon 33SL
To sharpen other follow chain manufacturer's instruction.

CHAIN AND GUIDE BAR COMBINATION

The following combinations are recommended for C S —5000

Guide Bar			Saw chain			
Length mm (in)	ECHO Part No.		Pitch mm(in)	Type	Links	
	Double Guard	Asymmetrical Guard Tip				
④ 406(16)	16AOAD3366	16E50K	8.26 (0.325)	OREGON	33SL	66
457(18)	18AOAD3372	18E50K	8.26 (0.325)	OREGON	33SL	72
508(20)	20AOAD3378	20E50K	8.26 (0.325)	OREGON	33SL	78

④ Standard configuration

WARNING  DANGER

Use of replacement saw chain and/or guide bar other than that specified, or operation without the "tip guard" in place may cause severe kickback resulting in serious injury.

Only use saw chain designated as, "LOW-KICKBACK", that meets the ANSI B175.1-1991 standard and the ECHO guide bar specified.

TROUBLE SHOOTING

Poor performance of the engine and/or cutting mechanism can normally be prevented by carefully following the above instructions.

Poor performances can easily be corrected even by a beginner.

When the engine does not function properly check the following three (3) points first.

- Is engine compression adequate?
- Is fuel system in good condition and is enough fuel being supplied?
- Is electrical system in good condition and is spark plug operating normally?

When there is serious trouble with the unit, do not try to repair it yourself but have your distributor or dealer do it for you. For detailed TROUBLE SHOOTING refer to tables 1 and 2. Locate the problem on the following charts and repair as necessary.

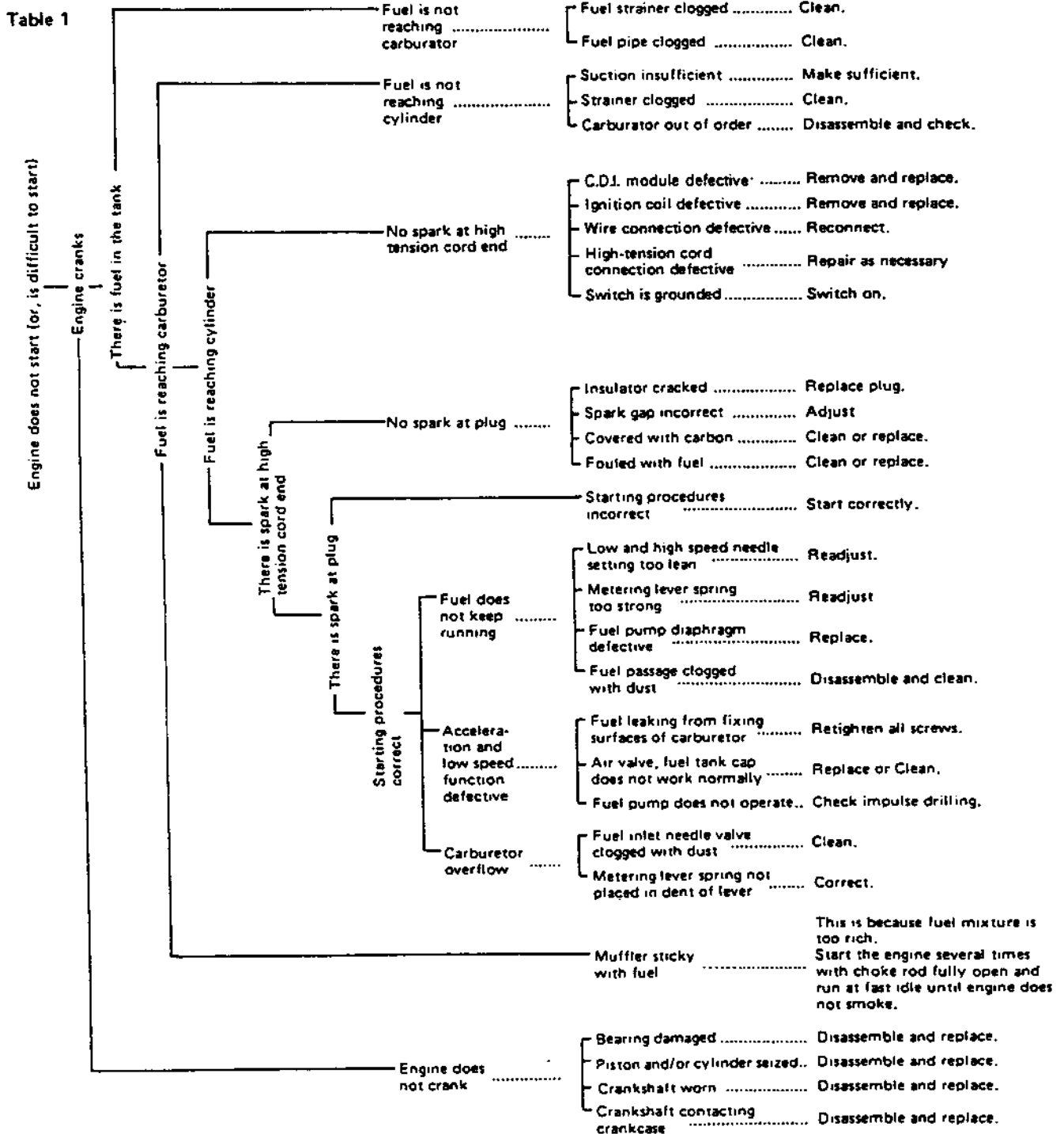
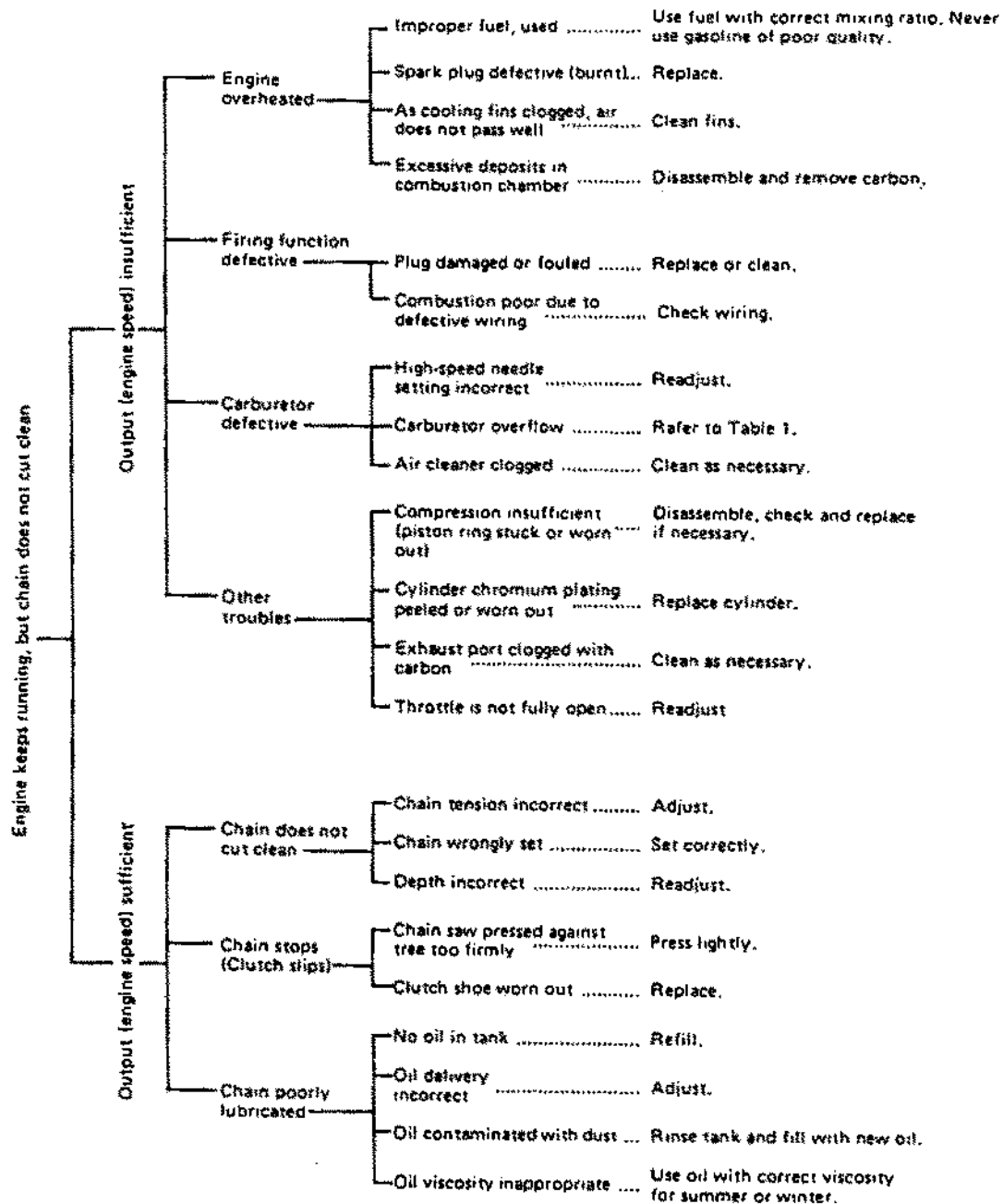

Table 2



STORAGE AFTER USE

- Inspect and adjust every part of the chain saw.
 - Completely clean every part, and repair, if necessary.
 - Apply thin coating of oil on metal parts to prevent rust.
 - Remove chain and guide bar, apply sufficient oil coating and wrap them up in plastic.
- Drain fuel tank, pull starter slowly a few times to drain fuel from carburetor.
- Pour a small amount of clean motor oil into spark plug hole, pull starter and crank the engine until the TOP DEAD CENTER.
- Store in a dry area, free from dust.

CHAIN BRAKE

The installation of a chain brake may be mandatory by law or as stipulated by insurance regulations in your area of operation. You should enquire through local government offices, your employer or your local dealer to ensure that your chain saw conforms to the required safety standard. Echo chain brakes have been designed and tested to comply with international safety standards as follows.

USA: ANSI Standard B175.1-1991 Safety Requirement for chain saws
Canada: CSA Standard Z 62.1 CHAIN SAWS

WARNING:

- ANSI Standard B175.1-1991 stipulates that the brake shall stop the chain in 0.10 seconds (one tenth) at an engine speed of 8000 r/min. It is the responsibility of the Owner/Operator to ensure that the brake is serviced, adjusted and tested strictly in accordance with the instructions as detailed herein in order to ensure that the brake performance is maintained in compliance with the Standard B175.1-1991.

CORRECT USE OF CHAIN BRAKE

Kickback Motion:

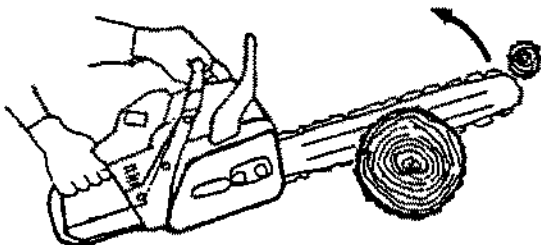

- When the bar nose hits another tree etc.

Function:

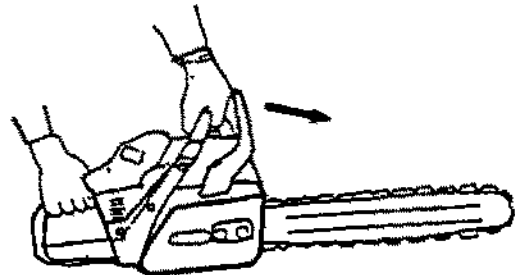

- When the lever is pushed forward, chain brake instantly works to stop the chain.

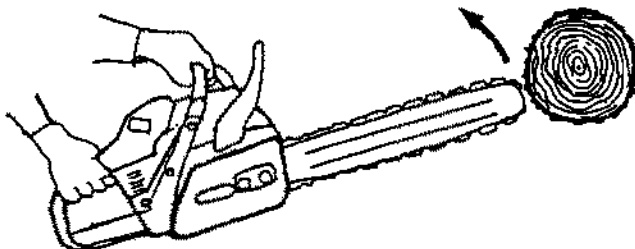

- Improper thrust cutting.

Release:

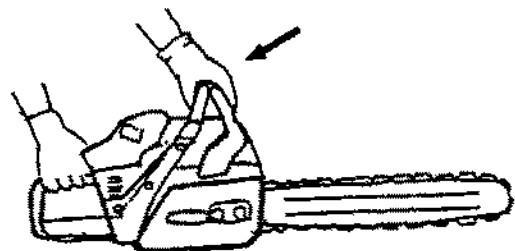

- When the lever is fully pulled toward the operator, brake is released.

INSTALLATION

- Echo recommends that the chain brake should be serviced by an authorized Echo servicing dealer.

OPERATION

- Set the lever in the released position before starting to cut.
- If the brake is tripped by kick back reaction, the chain will stop. Immediately release the throttle to avoid possible damage to the engine or clutch.
- Do not attempt to start or operate the engine with the brake engaged.

TESTING THE BRAKE

- Start the engine on a solid level surface and run at a fast idle until warm.
- Hold the saw firmly by the handles and accelerate the engine to a fast idle.
- Slowly operate the chain brake lever while holding the saw firmly on the ground. When the brake lever trips, the chain should stop. Immediately release the throttle trigger.

CAUTION

DO NOT ALLOW THE SAW TO TIP FORWARD IN ORDER TO AVOID DAMAGE TO THE CHAIN.

If the chain does not stop immediately return the saw to your authorized Echo dealer for repair.

ADJUSTING THE BRAKE BAND

When brake band is worn or elongated, adjust the location of adjuster peak as follows.

Remove sprocket guard.

- Remove the cover and side plate.
- Turn adjuster position to set its peak to the correct tensioning location.
- Ensure that clutch drum can be turned freely by hand when brake handle is in cutting position (released position).

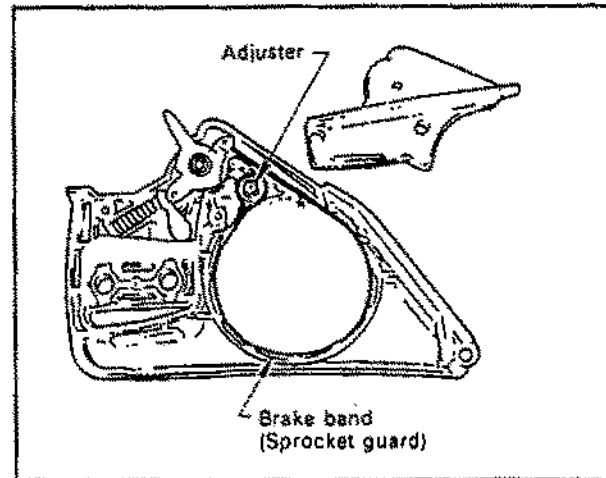
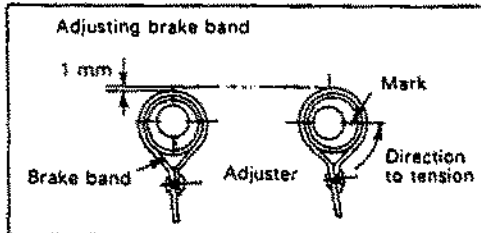

(NOTE)

- For practice, while cutting a small tree, push the lever forward to engage the brake.
- At all times, confirm whether the brake works properly before each work.
- If clogged with wood chips, function of the brake deteriorates a little. Always keep the device clean.
- Do not increase engine revolution while the chain brake is engaged.
- Chain brake is used only in emergencies. Do not use it unless absolutely necessary.
- When in use of throttle lock at starting, keep the chain brake position.
And after starting the engine, release the brake immediately.
- Never test the brake in an area where gasoline fumes are present.

AUTOMATIC CHAIN BRAKE

The automatic chain brake stops the operation of the saw chain in such a manner that kick-back action produced at the end of the guide bar automatically actuates the chain brake.

To make sure that the automatic chain brake operates properly, proceed as follows:

- 1) Stop the engine of the chain saw.
- 2) Operate the front and rear handles with hands (grip them lightly), so that the guide bar may be placed at the height of about 35 cm as shown in Fig.
- 3) Softly detach the left hand from the front handle, and touch the end of the guide bar against the wood or the like placed below so that the machine receives an impact.
(* at this time the rear handle should be gripped lightly with right hand.)
- 4) The impact is propagated to the brake lever, which actuates the chain brake

(PRECAUTION)

When checking the operation of the automatic chain brake, use a soft surface substance like wood to provide the impact so the saw chain is not damaged.

END OF THE GUIDE BAR may be placed at the height of about 35 cm.

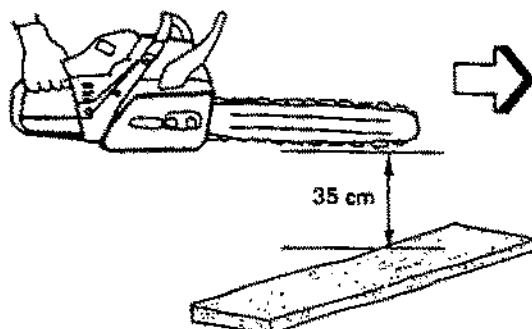

Rear handle should be gripped lightly with the right hand.

